

ISSN-L=1454-7376  
(Print)-ISSN 1454-7376  
(Online)=ISSN 2069-8275  
(CD-ROM) = ISSN 2069 – 847X

UNIVERSITATEA DE ȘTIINȚE AGRICOLE  
ȘI MEDICINĂ VETERINARĂ  
“ION IONESCU DE LA BRAD” DIN IAȘI



LUCRĂRI ȘTIINȚIFICE

Vol. 61

NR. 1

SERIA HORTICULTURĂ

EDITURA “ION IONESCU DE LA BRAD”



IAȘI 2018

## COLECTIVUL DE COORDONARE AL REVISTEI „LUCRĂRI ȘTIINȚIFICE”

**Redactor șef:** Prof. dr. Vasile VÎNTU - USAMV Iași, Romania  
**Redactor adjunct:** Prof. dr. Liviu MIRON - USAMV Iași, Romania  
**Membri:** Prof. dr. Costel SAMUIL - USAMV Iași, Romania  
Prof. dr. Lucia DRAGHIA - USAMV Iași, Romania  
Prof. dr. Gheorghe SĂVUȚĂ - USAMV Iași, Romania  
Prof. dr. Paul Corneliu BOIȘTEANU - USAMV Iași, Romania

## COLEGIUL DE REDACȚIE AL SERIEI „HORTICULTURĂ”

**Redactor șef:** Prof. dr. Lucia DRAGHIA – USAMV Iași, Romania  
**Redactor adjunct:** Conf. dr. Elena Liliana CHELARIU – USAMV Iași, Romania  
**Membri:** Prof. dr. Gheorghe CIMPOIEȘ - UASM Chișinău, R. Moldova  
Prof. dr. Ibrahim BAKTIR - Akdeniz University, Faculty of Agriculture, Turcia  
Prof. dr. Valerian BALAN - UASM Chișinău, R. Moldova  
Prof. dr. Monica Teresa BOȘCAIU NEAGU – Universidad Politécnica de València, Spania  
Prof. dr. Carlos CARBONELL CARRERA – Universidad de La Laguna, Spania  
Prof. dr. Monika CHRISTMANN - Forschungsanstalt Geisenheim University, Germania  
Prof. dr. Sina COSMULESCU – Facultatea de Horticultură, Universitatea din Craiova, Romania  
Prof. dr. Valeriu V. COTEA - USAMV Iași, România  
Prof. dr. Carmelo DAZZI - Università di Palermo, Italy  
Prof. dr. Athanasios ECONOMOU - Aristotle Univ. Thessaloniki, Grecia  
Prof. dr. Gheorghe GLĂMAN - ASAS București, Romania  
Prof. dr. Stefano GREGO - Univ. Tuscia-Viterbo, Italia  
Prof. dr. Gonca GÜNVER DALKILIÇ - Adnan Menderes University, Turcia  
Prof. dr. Dorel HOZA – USAMV București, Romania  
Prof. dr. Viorel MITRE – USAMV Cluj-Napoca, Romania  
Prof. dr. Neculai MUNTEANU - USAMV Iași, Romania  
Prof. dr. Radu SESTRĂȘ – USAMV Cluj-Napoca, Romania  
Prof. dr. Vicente SOTÉS RUIZ - Universidad Politécnica de Madrid, ETSIA, Spania  
Conf. dr. Dorin CAMEN – USAMVB Timișoara, Romania  
Assoc. Prof. dr. Zeynel DALKILIÇ - Adnan Menderes University, Turcia  
Conf. dr. Gheorghe NICOLAESCU - UASM Chișinău, R. Moldova  
Dr. Hervé QUÉNOL - CNRS - Université de Haute Bretagne - Rennes 2, Franța  
C.S. I dr. arh. Mariana ȘLAPAC - Institutul Patrimoniului Cultural al Academiei de Științe a R. Moldova

## COMISIA DE REFERENȚI ȘTIINȚIFICI

Prof. dr. Maria CANTOR - USAMV Cluj-Napoca  
Prof. dr. Valeriu V. COTEA - USAMV Iași  
Prof. dr. Doina Mira DASCĂLU - USAMV Iași  
Prof. dr. Alin DOBREI - USAMVB Timișoara  
Prof. dr. Lucia DRAGHIA - USAMV Iași  
Prof. dr. Mihai ISTRATE - USAMV Iași  
Prof. dr. Doina JITĂREANU - USAMV Iași  
Prof. dr. Mihail LUCA – UTI Iași  
Prof. dr. Neculai MUNTEANU - USAMV Iași  
Prof. dr. Servilia OANCEA - USAMV Iași  
Prof. dr. Daniela POPA – Facultatea de Horticultură din Craiova  
Prof. dr. Teodor ROBU- USAMV Iași  
Prof. dr. Liliana ROTARU - USAMV Iași  
Prof. dr. Culiță ȘIRBU - USAMV Iași  
Prof. dr. Mihai TĂLMACIU - USAMV Iași  
Prof. dr. Lucia Carmen TRINCĂ - USAMV Iași  
Prof. dr. Ioan ȚENU - USAMV Iași  
Prof. dr. Eugen ULEA - USAMV Iași  
Prof. dr. Ana VÎRSTA – USAMV București  
Conf. dr. Elena Liliana CHELARIU - USAMV Iași  
Conf. dr. Feodor FILIPOV - USAMV Iași  
Conf. dr. Liviu Mihai IRIMIA - USAMV Iași  
Conf. dr. Mihai MUSTEA - USAMV Iași  
Conf. dr. Cornelia PRISĂCARU - USAMV Iași  
Conf. dr. Vasile STOLERU- USAMV Iași  
Șef lucr. dr. Roberto Renato BERNARDIS - USAMV Iași  
Șef lucr. dr. Antoanela PATRAȘ - USAMV Iași  
Șef lucr. dr. Alina TROFIN - USAMV Iași  
CS I dr. Gelu CORNEANU - SCDP Iași  
CS I dr. Doina DAMIAN - SCDVV Iași

© Editura “Ion Ionescu de la Brad” Iași  
ISSN–L=1454-7376  
(Print)-ISSN 1454-7376  
(Online)=ISSN 2069-8275  
(CD-ROM) = ISSN 2069 – 847X

## COORDINATOR OF JOURNAL „LUCRĂRI ȘTIINȚIFICE”

**Manager Editor:** Prof. PhD. Vasile VÎNTU - UASVM Iași, Romania  
**Assistant Editor:** Prof. PhD. Liviu MIRON - UASVM Iași, Romania  
**Members:** Prof. PhD. Costel SAMUIL - UASVM Iași, Romania  
Prof. PhD. Lucia DRAGHIA - UASVM Iași, Romania  
Prof. PhD. Gheorghe SĂVUȚĂ - UASVM Iași, Romania  
Prof. PhD. Paul Corneliu BOIȘTEANU - UASVM Iași, Romania

## EDITORIAL BOARD OF „HORTICULTURA”

**Editor in chief** Prof. PhD. Lucia DRAGHIA – UASVM Iași, Romania  
**Assistant Editor** PhD, Assoc. Prof. Elena Liliana CHELARIU – UASVM Iași, Romania  
**Editors:** PhD, Prof. Gheorghe CIMPOIEȘ – SAUM Chișinău, R. Moldova  
PhD, Prof. Ibrahim BAKTIR – Akdeniz University, Faculty of Agriculture, Turkey  
PhD, Prof. Valerian BALAN – SAUM Chișinău, R. Moldova  
PhD, Prof. Monica Teresa BOȘCAIU NEAGU – Universidad Politécnica de València, Spain  
PhD, Prof. Carlos CARBONELL CARRERA – Universidad de La Laguna, Spain  
PhD, Prof. Monika CHRISTMANN – Forschungsanstalt Geisenheim University, Germany  
PhD, Prof. Sina COSMULESCU – Faculty of Horticulture, University from Craiova, Romania  
PhD, Prof. Valeriu V. COTEA – UASVM Iași, Romania  
PhD, Prof. Carmelo DAZZI – Università di Palermo, Italy  
PhD, Prof. Athanasios ECONOMOU – Aristotle University of Thessaloniki, Greece  
PhD, Prof. Gheorghe GLĂMAN – ASAS Bucharest, Romania  
PhD, Prof. Stefano GREGO – University of Tuscia-Viterbo, Italy  
PhD, Prof. Gonca GÜNVER DALKILIÇ – Adnan Menderes University, Turkey  
PhD, Prof. Dorel HOZA – UASVM Bucharest, Romania  
PhD, Prof. Viorel MITRE – UASVM Cluj-Napoca, Romania  
PhD, Prof. Neculai MUNTEANU – UASVM Iași, Romania  
PhD, Prof. Radu SESTRĂȘ – UASVM Cluj-Napoca, Romania  
PhD, Prof. Vicente SOTÉS RUIZ – Universidad Politécnica de Madrid, ETSIA, Spain  
PhD, Assoc. Prof. Dorin CAMEN – UASVMB Timișoara, Romania  
PhD, Assoc. Prof. Zeynel DALKILIÇ – Adnan Menderes University, Turkey  
PhD, Assoc. Prof. Gheorghe NICOLAESCU – SAUM Chișinău, R. Moldova  
PhD, Hervé QUÉNOL – CNRS - Université de Haute Bretagne - Rennes 2, France  
1<sup>st</sup> Researcher PhD arh. Mariana ȘLAPAC – Institute of Cultural Patrimony of Science Academy of R. Moldova

## SCIENTIFIC REVIEWERS

PhD, Prof. Maria CANTOR - UASVM Cluj-Napoca  
PhD, Prof. Valeriu V. COTEA - UASVM Iași  
PhD, Prof. Doina Mira DASCĂLU - UASVM Iași  
PhD, Prof. Alin DOBREI - UASVMB Timișoara  
PhD, Prof. Lucia DRAGHIA - UASVM Iași  
PhD, Prof. Mihai ISTRATE - UASVM Iași  
PhD, Prof. Doina JIȚĂREANU - UASVM Iași  
PhD, Prof. Mihail LUCA – UTI Iași  
PhD, Prof. Neculai MUNTEANU - UASVM Iași  
PhD, Prof. Servilia OANCEA - UASVM Iași  
PhD, Prof. Daniela POPA - Faculty of Horticulture from Craiova  
PhD, Prof. Teodor ROBU - UASVM Iași  
PhD, Prof. Liliana ROTARU - UASVM Iași  
PhD, Prof. Culiță ȘIRBU - UASVM Iași  
PhD, Prof. Mihai TĂLMACIU - USAMV Iași  
PhD, Prof. Lucia Carmen TRINCĂ - UASVM Iași  
PhD, Prof. Ioan ȚENU - UASVM Iași  
PhD, Prof. Eugen ULEA - UASVM Iași  
PhD, Prof. Ana VÎRSTA – UASVM Bucharest  
Rd. PhD. Elena Liliana CHELARIU - UASVM Iași  
Rd. PhD. Feodor FILIPOV - UASVM Iași  
Rd. PhD. Liviu Mihai IRIMIA - UASVM Iași  
Rd. PhD. Mihai MUSTEA - UASVM Iași  
Rd. PhD. Cornelia PRISĂCARU - UASVM Iași  
Rd. PhD. Vasile STOLERU - UASVM Iași  
Lect. PhD. Roberto Renato BERNARDIS - UASVM Iași  
Lect. PhD. Antoanela PATRAȘ - UASVM Iași  
Lect. PhD. Alina TROFIN - UASVM Iași  
1<sup>st</sup> Researcher PhD Gelu CORNEANU - FRDS Iași  
1<sup>st</sup> Researcher PhD Doina DAMIAN - VORDS Iași

“Ion Ionescu de la Brad” Publishing House Iași  
ISSN–L=1454-7376  
(Print)-ISSN 1454-7376  
(Online)=ISSN 2069-8275  
(CD-ROM) = ISSN 2069 – 847X

## CONTENT

1. <b>TROFIN Alina, UNGUREANU Elena, TRINCĂ Lucia Carmen, SANDU Tatiana, PARASCAN Letiția</b> - The modification of some chemical parameters for different brands of milk during refrigeration .....	11
2. <b>UNGUREANU Elena, ARITON Adina-Mirela, TROFIN Alina, JITĂREANU Carmen Doina, UNGUREANU O.C, POPA V.I.</b> - Chemical transformations and spectral characterization to PROTOBIND 3000 lignin .....	17
3. <b>CAZACU Ana, SPÂNU Mihaela, OANCEA Servilia, BODALE I.</b> - Spectrophotometric study of the heavy metal effects in animal blood .....	23
4. <b>CAZACU Ana, OANCEA Servilia, BODALE I.</b> - Analysis of proteins content from blood plasma of herbivorous and carnivorous animals .....	29
5. <b>BODALE I., OANCEA Servilia, CAZACU Ana</b> - Valorification of the economic potential of Rarau massif based on climate conditions .....	35
6. <b>BODALE I., CAZACU Ana</b> - Study of capillary hysteresis in medium texture soil using PREISACH model .....	41
7. <b>CHIRUȚĂ C.C., GAVĂT C.C., VASILESCU L.V., EARAR K., TROFIN Alina Elena, TRINCĂ Lucia Carmen, MĂRCULESCU Afrodita Doina</b> - The spectrophotometric analysis method of metamizole from pharmaceutical tablets: investigation of linearity, limit of detection and limit of quantification .....	47
8. <b>PRUNĂ L., SLONOVSKI A.</b> - Automatic graphical simulation of how to determine the true length of a line segment by changing a projection plan .....	53
9. <b>DINCĂ L., VASILE Diana, DINCĂ Maria, BLAGA Tatiana</b> - Rubus species present in <i>Alexandru Beldie</i> herbarium .....	61
10. <b>SESTRĂȘ P., CETEAN H., DAN Cătălina., NAS S., SPALEVIC V., BOSCAIU Monica, CÎMPEANU S.M.</b> - Floristic composition and diversity indices of woody species in Faget Forest, Cluj-Napoca, North Western of Romania .....	71
11. <b>BOIU-SICUIA Oana-Alina, BURLACU Aglaia, ISRAEL-ROMING Florentina, VOAIDEȘ Cătălina, CORNEA Călina Petruța</b> - Plant associated microorganisms with silica solubilization potential .....	77
12. <b>MANOLE Svetlana</b> - Improvement of daylilies ( <i>Hemerocallis</i> L.) in the Republic of Moldova .....	83



13.	<b>SESTRĂȘ Adriana, MILITARU M., TITIRICA (ANCU) I., DAN Cătălina, ANDRECAN A., MITRE V., SESTRĂȘ R.</b> – Yield and response to the main diseases attack of pear cultivars and heritability of the traits .....	91
14.	<b>CRISTEA Tina Oana, CĂLIN Maria, AMBARUȘ Silvica, BREZEANU Creola, BREZEANU P.M., PRISECARU Maria</b> - Genotypic competency in embryogenesis at <i>Brassica oleracea</i> microspores cultivated <i>in vitro</i> .....	97
15.	<b>PARASCHIV Luminița Nicoleta, VOLF Mariana, CHELARIU Elena Liliana</b> - Radicular fertilizations vs foliar fertilizations and their impact on the chemical composition of plants on a tomato culture .....	103
16.	<b>ENACHE Viorica, DONICI Alina, TABARANU G.</b> - The influence of the probable climate change on the vegetation phenophases on the Merlot variety in the Dealu Bujorului vineyard .....	107
17.	<b>FILIMON V.R., FILIMON Roxana, DAMIAN Doina, NECHITA Ancuța, ZALDEA Gabi, ALEXANDRU C., BĂETU M., ROTARU Liliana</b> - Evaluation of berry resistance to detachment and compression of some new <i>Vitis vinifera</i> L. cultivars for table grapes .....	111
18.	<b>FILIMON Roxana, FILIMON V.R., NECHITA Ancuța, ZALDEA Gabi, DAMIAN Doina, ROTARU Liliana</b> - Studies on the phenotypic similarity of autochthonous grapevine cultivars by means of statistical-mathematical methods .....	117
19.	<b>NECHITA Ancuța, ZALDEA Gabi, ALEXANDRU C., FILIMON R., FILIMON Roxana, DAMIAN Doina</b> - Studies on the influence of the load charged on the technological potential of red cultivated vineyards in the wine center of Iași Copou .....	123
20.	<b>PUȘCALĂU Marioara, BOSOI Ionica, MIHU G.</b> - Remus - new variety of vine for rose and red wines with high biological resistance .....	129
21.	<b>ROTARU Liliana, COLIBABA Lucia Cintia, AELENEI S.I.</b> - The agrobiological and technological value of ancient romanian grape varieties ( <i>Vitis vinifera</i> L.) cultivated in Iași vineyard .....	135
22.	<b>ROTARU Liliana, COLIBABA Lucia Cintia, CIMPOI V.I.</b> - Behaviour of various rootstocks on different trellising systems in Iași vineyard .....	139
23.	<b>SAVIN Gh., CORNEA V. , TOFAN Svetlana, BÎRSA Elena, BACA I. , BOTNARENCO A.</b> - Evaluation of new grapevine varieties and perspective elites in genofond of ISPHTA .....	143
24.	<b>PESTEANU A.</b> - The effect of the treatment with NAD and ANA based product on the productivity and quality of large fruit .....	149

25.	<b>SCURTU Gh., BUJOREANU N., HAREA I., NICUȚA A., PAȘA R.</b> - Analization of photosynthetic activity and transpiration activity in pear trees depending on the action of biological active substances .....	155
26.	<b>CROITORU N., PANUTA S., BODESCU C., LACATUSU Oana</b> - Some bioecological particularities and fighting against the main species of pests in the peas culture .....	163
27.	<b>PANUTA S., CROITORU N., BODESCU C., LACATUSU Oana</b> - Some aspects regarding the fight against cereals beetle in the conditions of the Republic of Moldova .....	169
28.	<b>PEI Gh., BRUDEA V.</b> - Parasitoid wasps and their influence on forest pest populations .....	177
29.	<b>BERNARDIS R., CHELARIU Elena Liliana, DASCĂLU M., ZLATI Cristina, PAȘCU Roxana, POȘTA Daniela</b> - Observations regarding multiplication on vegetative way of <i>Buxus sempervirens</i> L. species in Iași county conditions .....	183
30.	<b>BRINZA Maria, DRAGHIA Lucia, CHELARIU Elena Liliana, AIORDACHIAEI Andreea</b> - Copper effect on the seedling growth and development for the <i>Alyssum murale</i> species .....	189
31.	<b>CHELARIU Elena Liliana, COJOCARIU Mirela, DRAGHIA Lucia, BRÎNZĂ Maria, AVARVAREI B.V., BERNARDIS R., AMIȘCULESEI Petronica</b> - 'Sissi' - colour and perfume into the roses collection from UASVM Iași, Romania .....	197
32.	<b>CHELARIU Elena Liliana, Ghiorghe C., Turcu N.</b> - Influența vermicompostului asupra producerii răsadurilor de <i>Ocimum basilicum</i> L. ....	203
33.	<b>HANGAN (ISTRATE) Ana-Maria-Roxana, GACHE (LUNGU) Mirabela, TELIBAN G.C., STOLERU V.</b> - Preliminary studies regarding the use of vegetable species in the concept of urban gardens .....	207
34.	<b>MORARU Mihaela, BRÎNZĂ Maria, CHELARIU Elena Liliana, DRAGHIA Lucia</b> - Evaluation of different methods for drying of <i>Eryngium planum</i> and <i>Echinops ritro</i> flowers .....	213
35.	<b>PRUNĂ L., SLONOVSKI A.</b> - Fluxuri de lucru utilizate în proiectarea elementelor decorative dintr-o grădină .....	219
36.	<b>AVRAM Mihaela, LUCA M., MARCOIE N., LUCA Al. L.</b> - Pollution of the riparian environment by the Tazlăul Sărat upstream river .....	225
37.	<b>CHIRICA Ștefania, LUCA M., LATEȘ Iustina</b> - Considerations on the ground pollutant effect on drinking water conveyance pipes .....	231

38.	<b>LUCA Al. L., LUCA M., CHIRICA Ștefania, TOMA D.</b> - Considerations on the valuation rain - waters to waterings of the "green areas" of city .....	237
39.	<b>LUCA M., LUCA Al. L.</b> - Studies and research on pollution of the industry energy on the green area of the city .....	243
40.	<b>LUCA M., LUCA Al. L., MARCOIE N., AVRAM Mihaela</b> - Studies and research on environmental pollution to industrial waste deposits .....	249
41.	<b>ACHIȚEI V., GHEORGHITOAIIE M., TELIBAN G.C., COJOCARU A., STOLERU V.</b> - Preliminary results regarding the determination of the water supply of eggplants .....	255
42.	<b>GHEORGHITOAIIE M., ACHIȚEI V., TELIBAN G.C., STOLERU V.</b> - Preliminary results regarding electrostimulation of the physiological rithm by using continuous electric current in pepper crops .....	259
43.	<b>POPOVICI L., MIHĂILĂ Elena, COSTĂCHESCU C., CONSTANDACHE C.</b> - Can agroforestry systems be ordinary practices in Romania? .....	263
44.	<b>DARABAN G., BADEANU Marinela, RUSU Lăcrămioara, SUTEU Daniela</b> - Biopesticides a new challenge in assuring food quality and sustainable agriculture .....	269
45.	<b>BULGARIU E., CHIRUȚĂ C., CĂLIN M., LIPȘA F.D., GAFENCU A.M., ULEA E.</b> - A mathematical model of bacterial growth using soil bacterial communities .....	275
46.	<b>PATRAȘ Antoanela</b> - Quality parameters of apple fruits marketed in Iași .....	281
47.	<b>BACĂU Cristina, GÎDEA M., MIHALASCU C.</b> - Research on the economic efficiency of the agricultural ecosystem under agro-technical measures to crops of corn .....	287
48.	<b>DASCĂLU Doina Mira, COJOCARIU Mirela, GRECU Codrina, PAȘCU Roxana</b> - Relationship between urbanism and landscaping .....	295
49.	<b>GRECU Codrina, COJOCARIU Mirela, PURCARU A.</b> - Landscape planning of urban green spaces - psychological and social impact on the inhabitants of Iasi .....	299
50.	<b>COJOCARIU Mirela, CHELARIU Elena Liliana</b> - Utilization of 'Glorious' roses in urban landscape designs .....	305

## CUPRINS

1.	<b>TROFIN Alina, UNGUREANU Elena, TRINCĂ Lucia Carmen, SANDU Tatiana, PARASCAN Letiția</b> - Modificarea unor parametri chimici pentru diferite tipuri de lapte în condiții de păstrare la rece .....	11
2.	<b>UNGUREANU Elena, ARITON Adina-Mirela, TROFIN Alina, JITĂREANU Carmen Doina, UNGUREANU O.C, POPA V.I.</b> - Transformări chimice și caracterizarea spectrală la lignina PROTOBIND 3000 .....	17
3.	<b>CAZACU Ana, SPÂNU Mihaela, OANCEA Servilia, BODALE I.</b> - Studiu spectrofotometric al efectelor metalelor grele în sângele animal .....	23
4.	<b>CAZACU Ana, OANCEA Servilia, BODALE I.</b> - Analiza conținutului de proteine din plasma sanguină a animalelor erbivore și carnivore .....	29
5.	<b>BODALE Ilie, OANCEA Servilia, CAZACU Ana</b> - Valorificarea potentialului economic al masivului Rarău pe baza condițiilor climatice .....	35
6.	<b>BODALE Ilie, CAZACU Ana</b> - Studiul histerezisului capilar în soluri cu textura medie folosind modelul PREISACH .....	41
7.	<b>CHIRUȚĂ C.C., GAVĂȚ C.C., VASILESCU L.V., EARAR K., TROFIN Alina Elena, TRINCĂ Lucia Carmen, MĂRCULESCU Afrodita Doina</b> - Metoda de analiză spectrofotometrică a metamizolului din tabletele farmaceutice: investigarea linearității, a limitei de detecție și a limitei de cuantificare .....	47
8.	<b>PRUNĂ L., SLONOVSKI A.</b> - Simularea grafică automată a modului de determinare a adevăratei mărimi a unui segment de dreaptă utilizând schimbarea unui plan de proiecție .....	53
9.	<b>DINCĂ L., VASILE Diana, DINCĂ Maria, BLAGA Tatiana</b> - Speciile din genul <i>Rubus</i> prezente în herbarul <i>Alexandru Beldie</i> ....	61
10.	<b>SESTRĂȘ P., CETEAN H., DAN Cătălina., NAS S., SPALEVIC V., BOSCAIU Monica, CÎMPEANU S.M.</b> – Compoziția floristică și indicii de diversitatea speciilor lemnoase din Pădurea Făget, Cluj-Napoca, Nord Vestul României .....	71
11.	<b>BOIU-SICUIA Oana-Alina, BURLACU Aglaia, ISRAEL-ROMING Florentina, VOAIDEȘ Cătălina, CORNEA Călina Petruța</b> - Microorganisme benefice plantelor cu efect de solubilizare a siliciului .....	77
12.	<b>MANOLE Svetlana</b> - Ameliorarea crinului galben ( <i>Hemerocallis L.</i> ) în Republica Moldova .....	83

13. **SESTRAȘ Adriana, MILITARU M., TITIRICA (ANCU) I., DAN Cătălina, ANDRECAN A., MITRE V., SESTRAȘ R.** - Productivitatea și răspunsul la atacul principalelor boli ale unor soiuri de păr și heritabilitatea acestor caracteristici ..... 91
14. **CRISTEA Tina Oana, CĂLIN Maria, AMBARUS Silvica, BREZEANU Creola, BREZEANU P.M., PRISECARU Maria** - Studii privind competența genotipică în embriogeneza microsporilor de *Brassica oleracea* cultivați *in vitro* ..... 97
15. **PARASCHIV Luminița Nicoleta, VOLF Mariana, CHELARIU Elena Liliana** - Fertilizări radiculare vs fertilizări foliare și impactul acestora asupra compoziției chimice a plantelor, la o cultura de tomate ..... 103
16. **ENACHE Viorica, DONICI Alina, TABARANU G.** - Influența schimbărilor climatice probabile asupra fenofazelor de vegetație la soiul Merlot în podgoria Dealu Bujorului ..... 107
17. **FILIMON V.R., FILIMON Roxana, DAMIAN Doina, NECHITA Ancuța, ZALDEA Gabi, ALEXANDRU C., BĂETU M., ROTARU Liliana** - Evaluarea rezistenței la desprindere și compresiune a bachelor unor soiuri noi *Vitis vinifera* L. pentru struguri de masă ..... 111
18. **FILIMON Roxana, FILIMON V.R., NECHITA Ancuța, ZALDEA Gabi, DAMIAN Doina, ROTARU Liliana** - Studii privind gradul de asemănare fenotipică dintre unele soiuri autohtone de viță de vie prin utilizarea metodelor statistico-matematice ..... 117
19. **NECHITA Ancuța, ZALDEA Gabi, ALEXANDRU C., FILIMON R., FILIMON Roxana, DAMIAN Doina** - Studii privind influența încărcăturii de rod atribuită la tăiere asupra potențialului tehnologic al soiurilor roșii de viță de vie cultivate în centrul viticol Copou Iași ..... 123
20. **PUȘCALĂU Marioara, BOSOI Ionica, MIHU G.** - Remus - soi nou pentru obținerea vinurilor rose și roșii cu rezistență biologică ridicată ..... 129
21. **RO TARU Liliana, COLIBABA Lucia Cintia, AELENEI S.I.** - Valoarea agrobiologică și tehnologică a unor soiuri vechi românești de viță de vie (*Vitis vinifera* l.) cultivate în podgoria Iași ..... 135
22. **RO TARU Liliana, COLIBABA Lucia Cintia, CIMPOI V.I.** - Comportarea unor soiuri de vițe portaltoi cultivate pe diverse mijloace de susținere în podgoria Iași ..... 139
23. **SAVIN GH., CORNEA V., TOFAN SVETLANA, BÎRSA ELENA, BACA I., BOTNARENCO A.** - Evaluarea unor soiuri și elite de perspectivă de viță de vie în condițiile genofondului IȘPHTA ..... 143

24. **PESTEANU A.** - Efectul tratării cu produsul pe bază de NAD și ANA asupra productivității și calității fructelor de măr ..... 149
25. **SCURTU Gh., BUJOREANU N., HAREA I., NICUȚA A., PAȘA R.** - Analiza activității fotosintetice și transpirației la pomii de păr în dependență de acțiunea substanțelor biologice active ..... 155
26. **CROITORU N., PANUTA S., BODESCU C., LACATUSU Oana** - Unele particularități bioecologice și lupta împotriva principalelor specii dăunătoare în cultura de mazăre ..... 163
27. **PANUTA S., CROITORU N., BODESCU C., LACATUSU Oana** - Unele aspecte privind lupta împotriva dăunătorilor din culturile de cereale în condițiile Republicii Moldova ..... 169
28. **PEI G., BRUDEA V.** - Viespi parazitoide și influența lor asupra populațiilor de dăunători forestieri ..... 177
29. **BERNARDIS R., CHELARIU Elena Liliana, DASCĂLU M., ZLATI Cristina, PAȘCU Roxana, POȘTA Daniela** - Observații privind înmulțirea pe cale vegetativă a speciei *Buxus sempervirens* L. în condițiile județului Iași ..... 183
30. **BRINZA Maria, DRAGHIA Lucia, CHELARIU Elena Liliana, AIORDACHIAEI Andreea** - Efectul cuprului asupra creșterii și dezvoltării răsadurilor la specia *Alyssum murale* ..... 189
31. **CHELARIU Elena Liliana, COJOCARIU Mirela, DRAGHIA Lucia, BRÎNZĂ Maria, AVARVAREI B.V., BERNARDIS R., AMIȘCULESEI Petronica** - 'Sissi' - culoare și parfum în colecția de trandafiri de la USAMV Iași, România ..... 197
32. **CHELARIU Elena Liliana, Ghiorghe C., Turcu N.** - Influența vermicompostului asupra producerii răsadurilor de *Ocimum basilicum* L. .... 203
33. **HANGAN (ISTRATE) Ana-Maria-Roxana, GACHE (LUNGU) Mirabela, TELIBAN G.C., STOLERU V.** - Studii preliminare privind utilizarea speciilor legumicole în conceptul grădinilor urbane ..... 207
34. **MORARU Mihaela, BRÎNZĂ Maria, CHELARIU Elena Liliana, DRAGHIA Lucia** - Evaluarea diferitelor metode de uscare a florilor de *Eryngium planum* și *Echinops ritro* ..... 213
35. **PRUNĂ L., SLONOVSKI A.** - Fluxuri de lucru utilizate în proiectarea elementelor decorative dintr-o grădină ..... 219
36. **AVRAM Mihaela, LUCA M., MARCOIE N., LUCA AL. L.** - Poluarea mediului riveran pe cursul superior al râului Tazlăul Sărat .... 225

37. **CHIRICA Ștefania, LUCA M., LATEȘ Iustina** - Considerații privind efectul poluant al terenului asupra conductelor de transport ale apei potabile ..... 231
38. **LUCA Al. L., LUCA M., CHIRICA Ștefania, TOMA D.** - Considerații privind valorificarea apelor pluviale la udarea ”zonei verzi” a orașelor ..... 237
39. **LUCA M., LUCA Al. L.** - Studii și cercetări privind poluarea industriei energetice asupra zonei verzi a localităților ..... 243
40. **LUCA M., LUCA Al. L., MARCOIE N., AVRAM Mihaela** - Studii și cercetări privind poluarea mediului de către depozitele de deșeuri industriale ..... 249
41. **ACHIȚEI V., GHEORGHITOAIIE M., TELIBAN G.C., COJOCARU A., STOLERU V.** - Rezultate preliminare privind determinarea conținutului de apă în plantele pătlăgele vinete ..... 255
42. **GHEORGHITOAIIE M., ACHIȚEI V., TELIBAN G.C., STOLERU V.** - Rezultate preliminare privind electro-stimularea ritmului fiziologic prin utilizarea curentului continuu la ardeul gras ..... 259
43. **POPOVICI L., MIHĂILĂ Elena, COSTĂCHESCU C., CONSTANDACHE C.** - Sistemele agrosilvice pot fi practice obișnuite în România? ..... 263
44. **DARABAN G., BĂDEANU Marinela, RUSU Lăcrămioara, SUTEU Daniela** - Biopesticidele - o nouă provocare pentru asigurarea calității alimentelor și pentru o agricultură sustenabilă ... 269
45. **BULGARIU E., CHIRUȚĂ C., CĂLIN M., LIPȘA F.D., GAFENCU A.M., ULEA E.** - Un model matematic al creșterii bacteriilor utilizând comunitățile bacteriene din sol ..... 275
46. **PATRAȘ Antoanela** - Parametri de calitate a fructelor de măr comercializate în Iași ..... 281
47. **BACĂU Cristina, GÎDEA M., MIHALASCU C.** - Cercetări privind eficiența energetică a ecosistemului agricol sub influența măsurilor agrotehnice la cultura de porumb ..... 287
48. **DASCĂLU Doina Mira, COJOCARIU Mirela, GRECU Codrina, PAȘCU Roxana** - Relația dintre urbanism și peisagistică ..... 295
49. **GRECU Codrina, COJOCARIU Mirela, PURCARU A.** - Amenajarea spațiilor verzi urbane – impactul psihologic și social asupra locuitorilor din Iași ..... 299
50. **COJOCARIU Mirela, CHELARIU Elena Liliana** - Utilizarea trandafirilor ‘Glorious’ în diferite amenajări peisagistice urbane .... 305

## THE MODIFICATION OF SOME CHEMICAL PARAMETERS FOR DIFFERENT BRANDS OF MILK DURING REFRIGERATION

### MODIFICAREA UNOR PARAMETRI CHIMICI PENTRU DIFERITE TIPURI DE LAPTE ÎN CONDIȚII DE PĂSTRARE LA RECE

*TROFIN Alina*<sup>1\*</sup>, *UNGUREANU Elena*<sup>1</sup>,  
*TRINCĂ Lucia Carmen*<sup>1</sup>, *SANDU Tatiana*<sup>1</sup>, *PARASCAN Letiția*<sup>1</sup>

\*Corresponding author e-mail: alina.trofin@gmail.com

**Abstract.** Milk is one of the main foods especially in the diet of small children but not only theirs. In addition to consumption as pasteurized or high-temperature treated (UHT) milk, it is a raw material for making cheeses, yoghurts, other milk products, and many products in which it is used. It is an accessible source of calcium but also of fat, protein, lactose, other mineral substances, vitamins and enzymes. The fresh product being perishable is treated thermally to prolong the shelf life. The present paper analyzes the variation of different chemical parameters (pH, acidity, lactose content) under storage conditions at 4°C, and also the dry matter and nitrates contents for different types of milk marketed or distributed for consumption.

**Key words:** milk, chemical parameters, cold storage

**Rezumat.** Laptele face parte dintre alimentele de bază în special în alimentația copilor mici dar nu numai. Pe lângă consumul ca lapte pasteurizat sau tratat la temperaturi înalte (UHT), reprezintă materie primă în obținerea brânzeturilor, iaurturilor, altor derivate din lapte și a multor produse în a căror compoziție intră. Reprezintă o sursă accesibilă de calciu dar și de grăsimi, proteine, lactoză, alte substanțe minerale, vitamine și enzime. Produsul în stare proaspătă fiind perisabil, se tratează termic pentru a prelungi perioada de păstrare. Lucrarea de față analizează variația diferiților parametri chimici (pH, aciditate, conținut de lactoză) în condiții de păstrare la 4°C, alături de conținutul în substanță uscată și azoți pentru diferite tipuri de lapte comercializate sau distribuite către consum.

**Cuvinte cheie:** lapte, parametri chimici, păstrare la rece

## INTRODUCTION

Milk is a natural emulsion containing proteins (casein and whey proteins), antibodies, enzymes, glycerides and complex lipids, lactose and carbohydrates, liposoluble and water-soluble vitamins, minerals (calcium, potassium, phosphorus, etc.). Lactose is the only source of galactose - a component of galacto-cerebrosides and is the substrate for microorganisms that produce

---

<sup>1</sup>University of Agricultural Sciences and Veterinary Medicine Iasi, Romania



fermentation, of technological importance in the production of acidic dairy products and in the maturing of cheeses (Usturoi, 2008).

Due to the complex composition, milk is a perishable product and must be stored under refrigeration for transportation and marketing. A study on the influence of storage conditions of raw milk in Italy in 2013 showed that there were significantly altered coagulation properties of milk induced by the addition of rennet after 12 hours at 4-6 and 8-10<sup>0</sup>C and also the cream forming capacity decreased when stored in all variants, especially at 13-15<sup>0</sup>C. The authors recommend keeping the raw milk at 8-10<sup>0</sup>C on farms for up to 24 hours (Malacarne *et al*, 2013).

Cold storage also influences the physico-chemical parameters of the milk powder, with very significant effects on titratable acidity, humidity and dry matter content (Semeniuc *et al*, 2012).

An extensive study on the influence of the storage conditions of some cheeses described the increase in proteolytic index, pH and salt content as well as the change in organoleptic properties (Todaro *et al*, 2017).

This paper aims to analyze changes in physicochemical parameters for seven types of drinking milk (UHT, pasteurized bottled and bulk) during storage at 4-6<sup>0</sup>C without boiling after opening the packs.

## MATERIAL AND METHOD

The following milk brands were analyzed, with the characteristics offered by the producers:

P 1 – Zuzu (producer Albalact) Ingredients: standardized cow's milk 3.5% homogenised fat and pasteurized at high temperature. Nutritional information for 100 g of product: lipids 3.5 g, proteins 3.4 g, carbohydrates 4.5 g;

P 2 - Rarăul (producer Albalact) Ingredients: standardized cow's milk 3.5% homogenised fat and pasteurized at high temperature. Nutritional information for 100 g of product: energy value / 100 g: 62 kcal (259 kJ); protein 3.2 g, carbohydrate 4.5 g, lipids 3.5 g;

P 3 – La Dorna (producer Dorna Lactate) Ingredients: standardized cow's milk 3.5% homogenised fat and pasteurized at high temperature. Nutritional information for 100 ml of product: 62 kcal energy, 3.5 g fat, 3.2 g protein, 0.133 g sodium, carbohydrate 4.5 g;

P 4 – Milli (producer Milli) Ingredients: standardized cow's milk 3.5% homogenised fat and pasteurized at high temperature. Nutritional information for 100 ml of product: 62 kcal energy value; fat 3.5 g, protein 3.2 g, carbohydrate 4.5 g;

P 5 – Fulga (producer Albalact) Ingredients: standardized cow's milk 3.5% homogenised fat and pasteurized at high temperature. Nutritional information for 100 ml of product: 61 kcal energy value; fat 3.5 g, protein 3.2 g, carbohydrate 4.5 g;

P 6 – Fresh milk from the Rediu farm, pasteurized at 70<sup>0</sup>C;

P 7 – Vio (producer S.C. Ilvas, S.R.L) skimmed milk for consumer use, 1.8% fat.

The following physical and chemical parameters were tested: moisture and dry matter (by oven drying method at 105<sup>0</sup>C), pH (potentiometric method), titratable acidity (volumetric method and Thörner degrees expression), lactose content

(polarimetry method), nitrites content (Griess reagent colorimetric method and Spekol 1100). Titrations for the acidity values and pH values were performed at four-day intervals until the organoleptic properties were changed below the acceptability limit.

## RESULTS AND DISCUSSIONS

As regards the moisture and dry matter of the analyzed milk samples, the values are shown in figure 1.

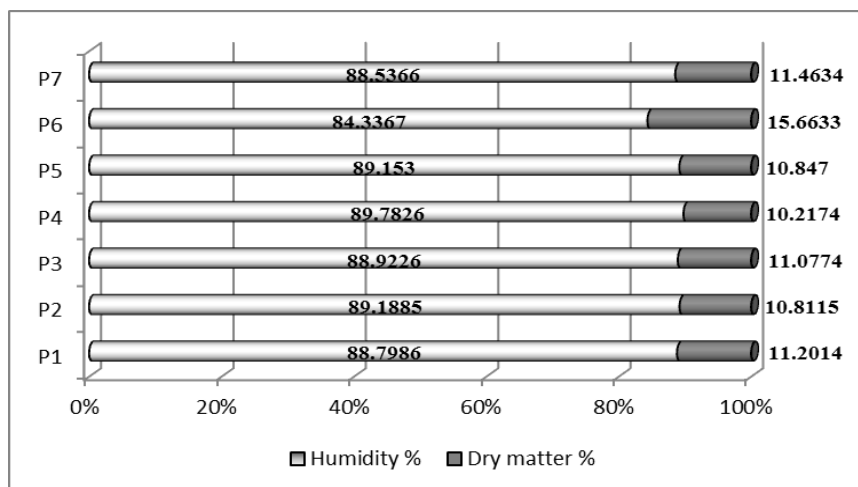


Fig. 1 Moisture and dry matter values for the analysed milk samples

The pH values were determined at the time of opening the pack and at four-day intervals, the samples being maintained at 4-6°C throughout the shelf life. Recorded data are shown in figure 2.

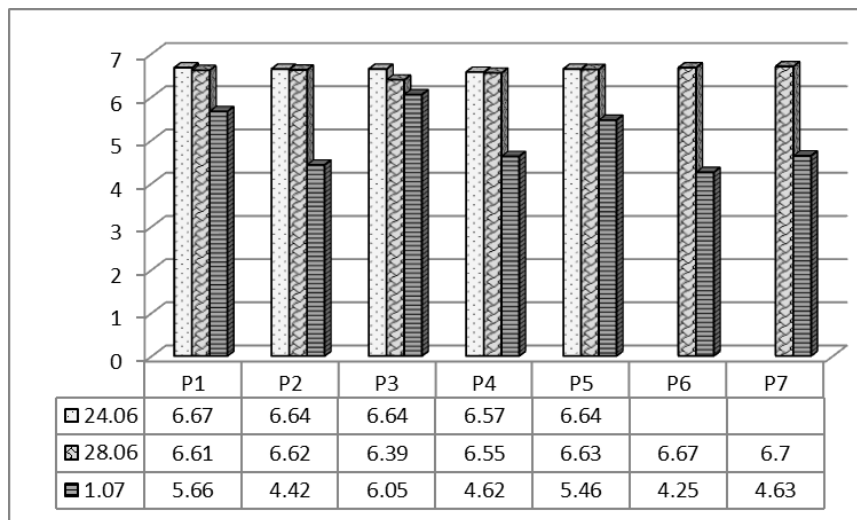
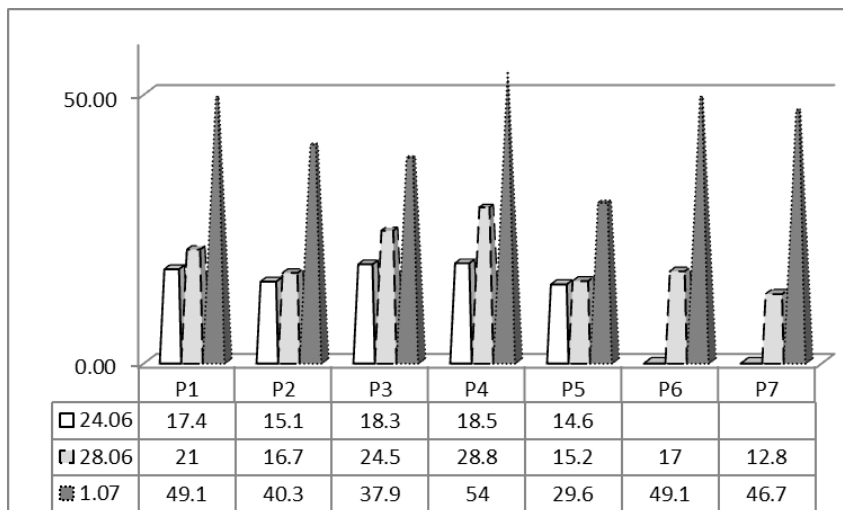


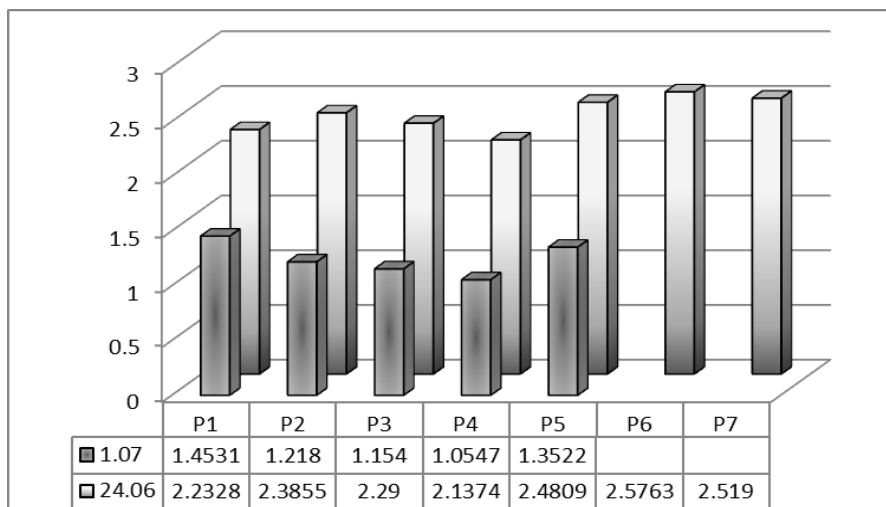
Fig. 2 Variation of pH-values during storage in refrigeration conditions

Acidity was expressed in degrees Thorner and the determinations were made at four and nine days after the opening of the packs. The values obtained are presented in figure 3.



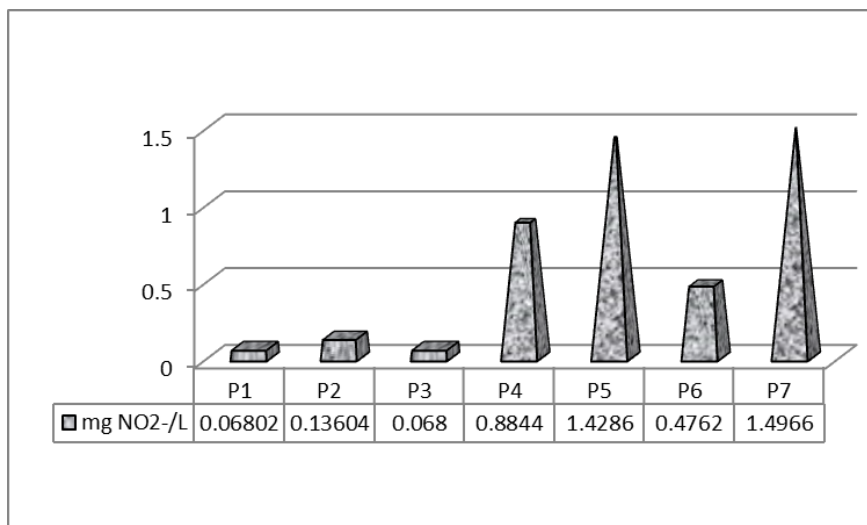
**Fig. 3** Variation of acidity values ( $^{\circ}$ T) in time for the considered milk samples

The lactose content was determined from deproteinized milk with 10% trichloroacetic acid solution by polarimetric method. For drinking milk ( $P_6$  and  $P_7$ ), a single determination was made at the opening of the package, and for the milk treated at high temperatures, two determinations were made at four days. The values obtained are presented in figure 4.



**Fig. 4** The lactose contents of the milk brands

The daily dose accepted for the ingestion of nitrates is 0 – 0.07 mg/kg (Yeh *et. al.*, 2013), therefore the nitrite content for the milk samples was determined, the values obtained being presented in figure 5.



**Fig. 5** Nitrites contents for the considered milk samples

## CONCLUSIONS

1. Milk is a daily food used in adults and, most important, children's diet, therefore it's essential to insure its quality;

2. Dry matter content of the considered seven brands of milk varied between 10.21 – 15.66%, more or less in accordance with the average 13% accepted for cow milk;

3. Most of the UHT milk brands dropped one or two units of pH in approximately ten days, except P<sub>3</sub>, where pH decreased only with 0.59 units, while fresh milk decreased 2.5 units in average after only four days;

4. Free acids content increased in four days of storage for the fresh milk three times or more, while the UHT samples resisted longer, with small changes after four days and significant ones after ten days; the sample which had the lowest acidity was P<sub>5</sub>;

5. The lactose content ranged from 2.12 – 2.57%, with a decrease to a half for all the UHT samples where this parameter was determined twice;

6. Only three brands of milk - P<sub>1</sub>, P<sub>3</sub> and P<sub>6</sub> – had smaller amounts of nitrites, therefore being appropriate for small children's diet. The highest nitrites contents were registered for P<sub>5</sub> and P<sub>7</sub> samples.

## REFERENCES

1. Malacarne M., Summer A., Franceschi P., Formaggioni P., Pecorari M., Panari G., Vecchia P., Sandri S., Fossa E., Scotti C., Mariani P., 2013 - *Effects of storage*

- conditions on physico-chemical characteristics, salt equilibria, processing properties and microbial development of raw milk*, International Dairy Journal, 29 (1), Elsevier, pp. 36-41;
2. **Semeniuc A. C., Muste S., Rotar M. A., Suharoschi R., Tofană M., 2012** - *Influence of the storage conditions on physicochemical parameters of infant formula*, Journal of Agroalimentary Processes and Technologies, 18 (1), pp. 61-64
  3. **Todaro M., Palmeri M., Settanni L., Scatassa M. L., Mazza F., Bonanno A., Di Grigo A., 2017** - *Effect of refrigerated storage on microbiological, chemical and sensory characteristics of a ewes' raw milk stretched cheese*, Food Packaging and Shelf Life, 11, Elsevier, pp. 67-73
  4. **Usturoi M.G., 2008** - *Tehnologia laptelui si a produselor derivate*, Editura Alfa, Colectia: Bios, ISBN 973-895-343-X.
  5. **Yeh T.S., Liao S.F., Kuo C.Y., Hwang W.I., 2013** - *Investigation of the nitrate and nitrite contents in milk and milk powder in Taiwan*, Journal of Food and Drug Analysis, 21, pp.73-79.

## CHEMICAL TRANSFORMATIONS AND SPECTRAL CHARACTERIZATION TO PROTOBIND 3000 LIGNIN

### TRANSFORMĂRI CHIMICE ȘI CARACTERIZAREA SPECTRALĂ LA LIGNINA PROTOBIND 3000

UNGUREANU Elena<sup>1\*</sup>, ARITON Adina-Mirela<sup>2</sup>,  
TROFIN Alina<sup>1</sup>, JITĂREANU Carmen Doina<sup>1</sup>,  
UNGUREANU O.C<sup>3</sup>, POPA V.I.<sup>4</sup>

\*Corresponding author e-mail: eungureanu@uaiasi.ro

**Abstract.** Lignin derivative (the commercial product - Protobind 3000) offered by the Granit Recherche Developement S.A. company, Lausanne-Schweitzerland was synthesized from annual plants. The present study's aim was to modify commercial lignins by the reaction of hydroxymethylation (produced in alkaline medium) and epoxydation (reaction with epichlorohydrin was performed in basic catalysis, aiming at increase the functionality) and to characterize the lignin derivatives chemical, spectral (<sup>1</sup>H NMR) and thermogravimetric analysis (TG). Studies have revealed some functional changes related to the difference in reactivity and reaction conditions.

**Key words:** Protobind 3000, lignin, hydroxymethylation, epoxydation, spectral and thermogravimetric analysis

**Rezumat.** Lignina derivativă (produsul comercial Protobind 3000) oferită de firma Granit Recherche Developement S.A. Lausanne-Elveția a fost sintetizată din plante anuale. Scopul prezentului studiu este a de a modifica ligninele comerciale prin reacția de hidroximetilare (produsă în mediul alcalin) și epoxidare (reacție cu epichlorhidrina în cataliza bazică ce crește funcționalitatea) și de a caracteriza derivații ligninici prin analize chimice, spectrale (<sup>1</sup>H RMN) și termogravimetrice (TG). Studiile au relevat unele modificări funcționale legate de diferența de reactivitate și condițiile de reacție.

**Cuvinte cheie:** Protobind 3000, lignină, hidroximetilare, epoxidare, analize termogravimetrice și spectrale

## INTRODUCTION

Lignin is one of the main components of vegetal tissue, where it plays an important role, owing to its noncrystalline network structure it operates like a natural adhesive component. The huge quantities of lignin resulted from cellulose and paper industry determined the scientists to increase the studies regarding the usefulness of this polymer, leading to economical and ecological advantages<sup>1</sup>. (Benar *et al*, 1999; Ungureanu, 2011).

<sup>1</sup>University of Agricultural Sciences and Veterinary Medicine, Iasi, Romania

<sup>2</sup>Station for Cattle Breedind, Dancu, Iasi, Romania.

<sup>3</sup>“V.Goldiș” West University of Arad, Romania.

<sup>4</sup>“Gh. Asachi” Technical University of Iasi, Romania.

It is known that lignin has a very complex structure, which varies depending on the plant species, separation method and modification reactions that may induce particular characteristics. Regarding functional groups lignin presents at least three base functional groups in its structure: methoxylic, hydroxylic (alcoholic and phenolic) and the lateral propanic chain. Alongside these functional groups, in lesser amounts, there can be found carbonylic groups (approximate 1 group of CO at 5 C9 units), most of the times, fixated at the lateral chain. In some cases, the presence of carboxylic groups into the lignin can be noticed under the form of phenol carboxylic acids or of some small quantities of lactonic groups (Ungureanu *et al*, 2009, 2016).

Lignin modification through hydroxymethylation and epoxydation offers possibilities of developing its functionality and this allows the extension of the application area for the synthesized derivatives.

Taking into account all these aspects, the objectives of this study are the modification of some lignin's from annual plants through a reaction of hydroxymethylation produced in an alkaline medium in the presence of formic aldehyde and of epoxydation effected out in an alkaline medium in the presence of epichlorhydrin and the characterization of lignin derivatives from a chemical, spectral ( $^1\text{H NMR}$ ) and thermogravimetric methods.

## MATERIAL AND METHOD

The following materials have been used:

- Protobind 3000 (Pb3000), commercial lignin offered by Granit Recherché Développement Switzerland, with the following chemical characteristics presented in table 1.

Table 1

The characteristics Protobind 3000

Characteristics	Protobind 3000
Solide, %	95
Ash, %	1.3
pH (10 % dispersion)	6.20
Densitatea, g/mL	~ 0.3
Aromatic OH, mmole/g	1.9
COOH, mmole/g	2.6-2.7
T softening, °C	~ 200
Solubility in furfuryl alcohol, %	42.10
Solubility in aqueous alkali, %	93.8

- Formic aldehyde (37 %);
- Dimetil sulfoxid (DMSO);
- NaOH solution 0.1 N;
- Epichlorhydrin.

### **Work procedure:**

#### **The hydroxymethylation reaction**

The method used in the hydroxymethylation of the three lignin products was performed in a basic medium, in the presence of formic aldehyde (37 %), according to the technical literature (Ungureanu, 2011).

**Determination of total hydroxyl groups**

The total OH groups content was determined by chemical method with acetic anhydride in pyridine medium and from FT-IR spectral analysis. The Ar-OH group's content was determined by a UV-VIS method.

**The epoxidation reaction**

The epoxydation method achieved in a basic medium in the presence of epichlorhydrin through which the three types of lignin studied have been modified has been effected out according to the technical literature (Ungureanu, 2011).

**Epoxydation index**

Determination of the epoxy group was effected out by HCl addition on the epoxy group and titration of the acid excess with NaOH solution 0.1 N.

**Proton nuclear magnetic resonance spectroscopy (<sup>1</sup>H NMR)**

Nuclear magnetic resonance (NMR) offers the richest and most complete information on the structure of organic compounds. For this purpose it was used a Bruker Avance DRX 400 MHz spectrometer.

**Process:** For investigation was necessary lignin acetylation and derivatives for a better dissolution in DMSO-d<sub>6</sub>. To obtain a "good" spectrum it is required to have concentrations of about 0.2 mmol/mL. Spectra processing was performed with a specialized program from SpectraManager series.

**Thermogravimetry**

The thermal analysis was performed using the METTLER TOLEDO derivatograph in N<sub>2</sub> atmosphere with a flow of 20mL/min and a heating rate of 15°C/min, in the temperature range 25-800 °C and sample mass of 4 ÷ 6 mg.

**RESULTS AND DISCUSSIONS**

During the reaction of hydroxymethylation performed for lignin, the reaction conditions have been varied (50°C temperature, 90°C respectively, reaction duration of three hours and pH 10.5, pH 12 respectively) in order to obtain highly functional products.

The content of functional groups was determined according to the methods presented by different research groups. The other methods applied for chemical characterization were: the determination of carboxylic groups and of the metoxyl groups, the determination aromatic hydroxyl groups, the calculation of the fenolic groups/aliphatic groups' ratio, as well as, the determination siringyl/guaiacyl unit's ratio (S/G).

The information obtained has allowed the determination from this point of view of the optimal reaction conditions, namely: 90°C temperature, pH 10.5 and the reaction duration of three hours (tab. 2).

Table 2

**The content of functional groups of modified and unmodified lignins**

Sample	T, °C	pH	OH total groups	Ar-OH groups	OCH <sub>3</sub> groups	Ar/OH ratio	C=O groups	S/G ratio
Pb 3000	-	-	1.13	0.90	1.09	1.13	0.87	0.86
	90	12.0	1.19	0.92	1.13	1.17	0.91	0.90
	90	10.5	1.15	0.97	1.16	1.24	0.93	0.95
	50	10.5	1.16	0.93	1.15	1.20	0.93	0.92
	50	12	1.17	0.95	1.12	1.19	0.93	0.95



The lignin obtained in optimal conditions there was characterized from the point of view spectral and thermogravimetric. As a consequence of the thermal analyses, it can be noticed that the modified product has a higher degradation temperature in the third stage, compared to the unmodified sample (tab. 3).

Table 3

**Characteristics of the thermal degradation process of the lignin derivatives**

Samples	Degradation stage	T <sub>i</sub> (°C)	T <sub>max</sub> (°C)	T <sub>f</sub> (°C)	Mass losses (%)
Pb3000	I	54	72	88	2.18
	II	147	196	267	11.01
	III	267	369	479	46.73
Pb3000H	I	54	77	116	6.53
	II	241	257	330	13.50
	III	330	379	570	31.49

(T<sub>i</sub> - initial temperature at which the degradation starts; T<sub>max</sub> – temperature corresponding to the maximum rate of degradation, T<sub>f</sub> – final temperature și W – mass losses %).

The characterization of the lignin has been achieved by monitoring the influence of temperature (50°C and 70°C respectively), the mass ratio between the lignin (L) and NaOH (L:NaOH = 1:3 and 1:6) and the reaction duration (3, 5 and 7 hours respectively). It can be noticed from table 4 that the best results can be obtained when the reaction is achieved at 70°C, for a L:NaOH=1:3 ratio and a three-hour reaction duration, appreciated as being *optimal reaction* conditions. The reaction yield was included in the 50-90 % interval, related to the mass of the reactants and it differs according to the type of sublayer and the purification degree after washing the derivatives. It can also be noticed that along with the temperature increase and the reaction duration, from 3 to 7 hours, appear a decrease of the epoxydation number (tab. 4) (Ungureanu *et al.*, 2017).

Table 4

**Characteristics of the modified lignin's by epoxydation**

Sample	T, °C	L:NaOH (w/w)	t, h	CE, %		η, %	U, %	Ash %	Const. f.liq, %
				f.sol.	f.liq.				
Pb3000E	70	1:6	3	1.25	0.25	58	5.7	8.14	16.3
	70	1:3	3	1.80	0.70	68	6.8	4.42	17.56
	50	1:3	3	1.32	0.28	64	5.31	6.30	14.15
	70	1:3	5	1.40	0.42	58.2	5.47	5.13	15.12
	70	1:3	7	1.46	0.30	60.5	6.20	7.10	14.44

For characterization by <sup>1</sup>H-NMR spectroscopy the lignin was subjected to acetylation to aid dissolution in DMSO-d<sub>6</sub>. In figures 1 and 2 are shown the <sup>1</sup>H-NMR spectra for Pb3000 lignin unmodified (Pb3000N) and hydroxymethylation

(Pb3000H), and the results were interpreted using literature data. The spectrum recorded for the two lignins weak signals in the aromatic domain at 8.64 ppm and the methoxyl groups.

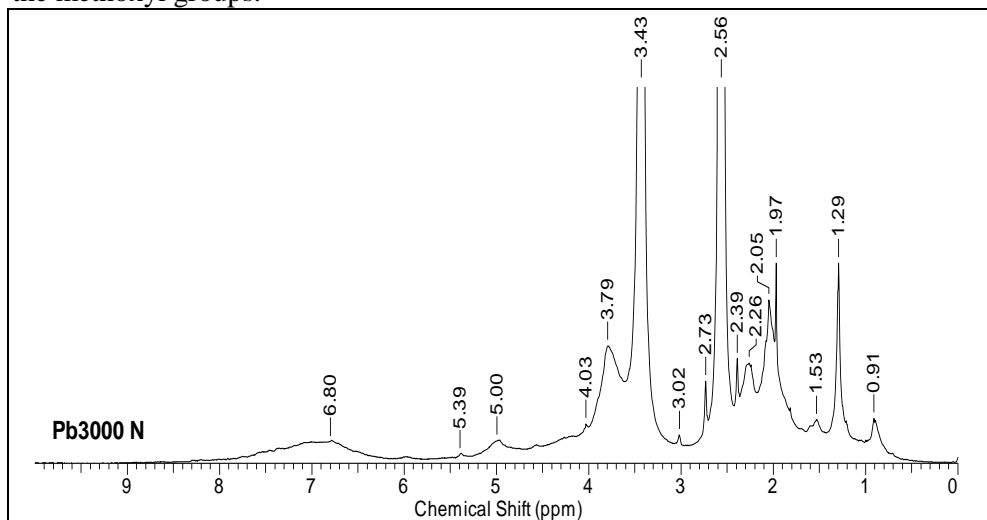


Fig. 1 <sup>1</sup>H-NMR spectra for unmodified lignin Pb3000

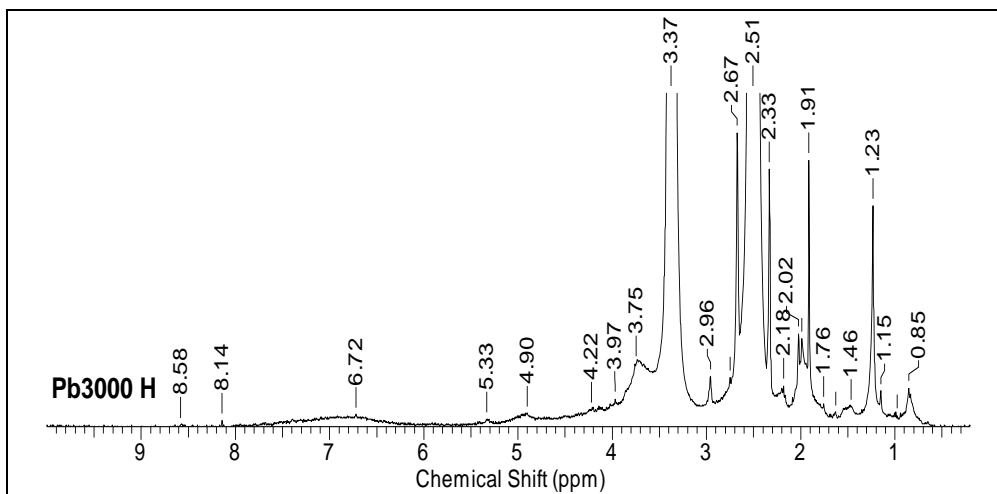


Fig. 2 <sup>1</sup>H-NMR spectra for modified lignin Pb3000H

Signals from 9.08-7 ppm confirms the presence of epoxy groups in lignin structure. Also stands out the signals of methoxyl and acetyl groups, more intense in the spectra of epoxidised lignin (fig. 3).

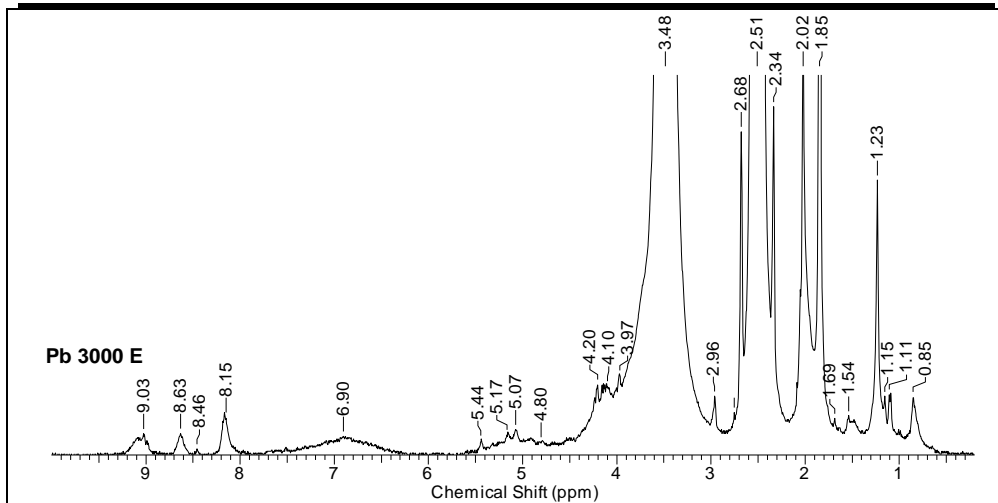


Fig. 3  $^1\text{H-NMR}$  spectra for modified lignin Pb3000E

## CONCLUSIONS

1. The  $^1\text{H-NMR}$  spectroscopy shows the change of functionality for lignin as a result of hydroxymethylation and epoxydation reaction.

2. The thermogravimetric analyses have proved that thermal degradation occurs in two and three stages respectively, according to the type and the degree of modification of the products tested but the hydroxymethylated /epoxydated derivatives have a higher thermostability, compared to the unmodified lignin.

## REFERENCES

1. Ariton Adina-Mirela, Creangă T., Trincă Lucia Carmen, Borș S.I., Ungureanu Elena, Măluțan Th., Popa V.I., 2015 - Valorization of lignin modified by hydroxymethylation to ensure birch veneer bioprotection, Cell. Chem. and Technol., 49 (9-10), p. 765-774.
2. Benar P., Gonplves A. R., 1999 - Principal component analysis of the hydroxymetylation of sugarcane lignin: A time-depending study by FTIR, J. Wood Chem. Technol., 19 (1-2), p.15 1-165.
3. Ungureanu Elena, Jităreanu Carmen Doina, Trofin Alina, Ungureanu O.C., Popa V.I., 2017 – Lignin derivatives modified by hydroxymethylation and apoxydation reactions, Lucrări Științifice, Seria Horticultură, nr.60, vol.1, p.23-28.
4. Ungureanu Elena, 2011 - Lignina, polimer natural aromatic cu ridicat potențial de valorificare, Ed. PIM, Iași, p. 112.
5. Ungureanu Elena, Ungureanu O., Căpraru Adina-Mirela, Popa V.I., 2009 - The chemical modification and the characterization the straw lignin, Cell. Chem. and Technol., 43 (7-8), p. 263-269.
6. Ungureanu Elena, Trofin Alina, Ariton Adina-Mirela, Jităreanu Carmen Doina, Ungureanu O., Gîlcă Valerica, Bors S.I., Popa V.I., 2016 - Applications of epoxydated lignins for bioprotection of lignocellulosic materials, Cell. Chem. and Technol., 50 (1), p. 77-85.

## SPECTROPHOTOMETRIC STUDY OF THE HEAVY METAL EFFECTS IN ANIMAL BLOOD

### STUDIU SPECTROFOTOMETRIC AL EFECTELOR METALELOR GRELE ÎN SÂNGELE ANIMAL

CAZACU Ana<sup>1</sup>, SPÂNU Mihaela<sup>1</sup>, OANCEA Servilia<sup>1</sup>, BODALE I.<sup>1\*</sup>

\*Corresponding author e-mail: ilie.bodale@uaiasi.ro

**Abstract.** *In order to obtain information on the alteration of blood structure in the presence of heavy metals, mercury and lead, the modification of the absorption maxima of oxyhemoglobin was analyzed. Blood samples were collected from three healthy animal species: cows, horses and dogs. For the samples, 20 ml of 5% HgCl<sub>2</sub> and Pb(NO<sub>3</sub>)<sub>2</sub> solution and 0.5 ml of blood from each species have been prepared. The obtained experimental results have shown that heavy metals affect certain biophysical characteristics of hemoglobin in the blood of the studied animals. The strongest effect has been obtained in the case of mercury, which is the most toxic heavy metal; for the horse blood sample at the wavelength of 410 nm, the absorption measurement gave an error, indicating that the sample was severely degraded.*

**Key words:** spectrophotometric study, heavy metals, oxyhemoglobin

**Rezumat.** *În vederea obținerii de informații privind alterarea structurii sângelui în prezența metalelor grele, mercur și plumb, s-a analizat modificarea maximelor de absorbție ale oxihemoglobinei. Probele de sânge au fost prelevate de la trei specii de animale sănătoase: vacă, cal și câine. Pentru probele de studiat s-a folosit 20 ml soluție de HgCl<sub>2</sub> și Pb(NO<sub>3</sub>)<sub>2</sub> de concentrație 5% și 0,5 ml sânge de la fiecare specie în parte. Rezultatele experimentale obținute au arătat că metalele grele afectează anumite caracteristici biofizice ale hemoglobinei din sângele animalelor studiate. Cel mai puternic efect a fost obținut în cazul mercurului, care este și cel mai toxic metal greu; pentru proba de sânge de cal, la lungimea de undă de 410 nm, măsurarea absorbției a dat eroare, ceea ce arată că proba era puternic degradată.*

**Cuvinte cheie:** studiu spectrofotometric, metale grele, oxihemoglobină

## INTRODUCTION

The effect of heavy metals on health is one of the many aspects studied, given that environmental pollution affects the food of humans and all living creatures. One of the methods by which this effect can be highlighted is based on blood tests. The study of blood biophysical parameters in various animal species in relation to their normal state and pathological conditions is among the most recent areas studied in the world. It was observed that the properties of blood differ from one species to another, although the blood structure is relatively similar. A different behaviour of the studied animal blood was also observed in

<sup>1</sup>University of Agricultural Sciences and Veterinary Medicine Iasi, Romania

the case of the heavy metal action on oxyhemoglobin, especially in the case of mercury that is the most toxic heavy metal. In this paper, the effect of two heavy metals on hemoglobin of some domestic animals is spectrophotometrically analyzed. Heavy metals are difficult to remove from the environment and, unlike other pollutants, cannot be biologically or chemically degraded, being essentially indestructible. Mercury and lead are toxic elements whose essence for the body has not yet been proven. Introduced in the body by ingestion or inhalation, in sufficient quantities, have toxic effects. These effects are produced when the biochemical reactions are altered. It seems, however, that any element, in a certain amount, becomes toxic (Neathery and Miller, 1975). As heavy metals are so widely used, they have a real potential hazard to the health of animals and humans (Gwaltney-Brant, 2013). Lead and mercury are considered to be two of the most toxic elements for living organisms. Mercury intoxications in animals are commonly encountered in practice. This is explained by the fact that mercury is among the polluting elements that dispute its primacy with lead and cadmium (Kummrow *et al*, 2007). The spectrophotometric analysis allows the detection of a very small amount of toxic substance in blood (Rapa and Oancea, 2006).

## MATERIAL AND METHOD

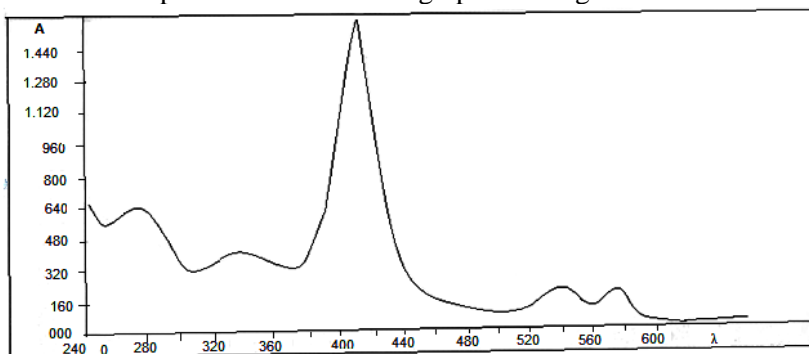
Blood samples were taken from three healthy animal species at the Faculty of Veterinary Medicine, Iasi. Samples were collected from the jugular vein of the cow and horse, and from the cephalic vein of the dog. Blood was collected in tubes containing EDTA as anticoagulant to prevent clotting of blood taken out of the body. The anticoagulant used was chosen so that it does not alter, by its action, the morphology and structure of the cells in the blood. For dilutions were used blood samples from horse, cow and dog; distilled water; solutions of mercury chloride ( $\text{HgCl}_2$ ) and lead nitrate  $\text{Pb}(\text{NO}_3)_2$ . Three sets of samples of three dilutions were prepared. Control samples contain 20 ml of distilled water to which were added 0.5 ml of blood from each species. For the samples, 20 ml of 5%  $\text{HgCl}_2$  or 5%  $\text{Pb}(\text{NO}_3)_2$  solution and 0.5 ml of blood from each species have been prepared. Spectrophotometric measurements were performed using a T70 UV-VIS Spectrophotometer from PG Instruments Ltd. with a spectral range between 190 and 1100 nm.

## RESULTS AND DISCUSSIONS

Spectrophotometric analysis of the hemoglobin spectrum, both simple and in combination with heavy metals, allows highlighting the changes in hemoglobin caused by heavy metals. Four hemoglobin derivatives are known: oxyhemoglobin ( $\text{HbO}_2$ ), carboxyhemoglobin ( $\text{HbCO}$ ), hemoglobin and methemoglobin. The spectrum is different depending on these hemoglobin derivatives. Hemoglobin has an absorption band in the green, with the maximum at 555 nm. If the hemoglobin molecule binds to oxygen, then oxyhemoglobin is formed and the spectrum is different. Oxihemoglobin has two absorption bands, one in the yellow range and one in the green. Carboxyhemoglobin has a similar spectrum to

oxyhemoglobin, but the bands are shifted toward lower wavelengths. Methemoglobin presents a red absorption band with a peak at 633 nm.

In order to show the absorption maxima of oxyhemoglobin (since we worked with blood in the presence of air, oxihemoglobin was obtained), the spectrum of oxyhemoglobin in UV (0 - 400 nm) and VIS (400 - 700) nm was recorded. A dilution of 10 ml of distilled water and 1 ml of blood was used to prepare control samples and to obtain the graph from figure 1.



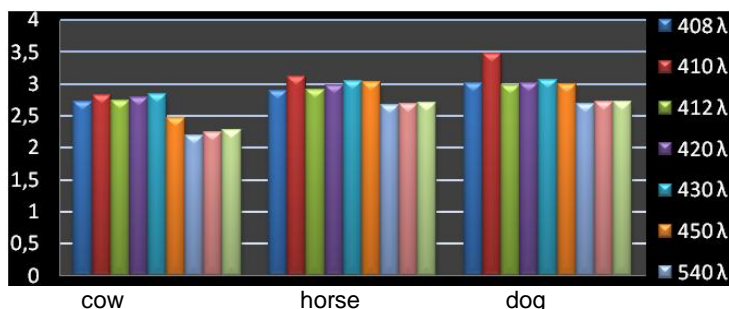
**Fig. 1** The absorption spectrum of oxyhemoglobin in the 240 - 600 nm range

Figure 1 shows that in the visible range, the oxyhemoglobin absorption maxima are at 410 nm, 540 nm and 577 nm, in accordance with specialty literature (Galaris *et al*, 1995). For this reason, absorption measurements of oxyhemoglobin to analyze the effect of heavy metals were carried out at these wavelength values, and also at values close to these. Table 1 shows the absorbance values of the control samples at different wavelengths.

Table 1

The absorbance values for control samples

Control sample	Wavelength (nm)						
	408	410	412	420	430	450	540
Cow	2.719	2.819	2.738	2.794	2.839	2.468	2.188
Horse	2.901	3.116	2.903	2.983	3.044	3.027	2.663
Dog	3.005	3.481	2.983	3.017	3.067	2.991	2.681



**Fig. 2** Dependence of absorption on the wavelength of control samples

As can be seen from table 1 and figure 2, the maximum absorbance value for the blood of cow is at 430 nm, and for the blood of horse and dog at 410 nm.

After diluting the blood samples with mercuric chloride, absorbance measurements were performed (table 2). Shortly after the dilutions, a rapid degradation of the samples was observed.

Table 2

The absorbance values for samples containing mercury

Sample	Wavelength (nm)						
	408	410	412	420	430	450	540
Cow+Hg	2.147	3.993	1.924	1.622	1.413	1.194	3.009
Horse+Hg	3.307	-	3.258	3.291	3.351	3.252	3.922
Dog+Hg	3.174	5.432	3.153	3.229	3.301	3.367	4.093

In the case of samples containing mercury, the maximum absorbance for cow blood sample is at 410 nm, for horse blood sample at 540 nm (at 410 nm the device could not record the value), and for dog blood sample at 410 nm (fig. 3).

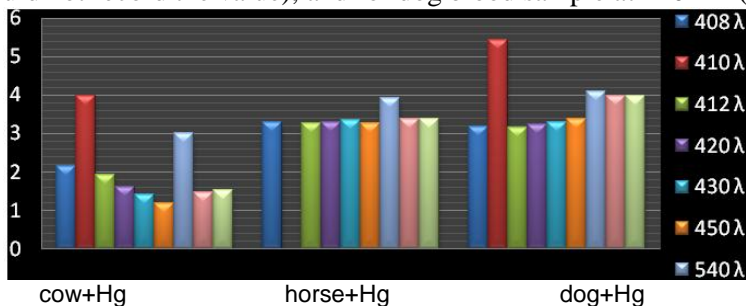


Fig. 3 Dependence of absorption on the wavelength of samples with mercury

The appearance of blood samples with mercury was visibly changed. Samples were less transparent, with deposits on the bottom of the cuvette. The most affected was the horse blood sample, for which the spectrophotometer could not measure any value at the wavelength of 410 nm. Fig. 4 shows the difference between blood control samples and the ones containing mercury, for horse.



Fig. 4 Control horse blood samples (left) and horse blood with mercury samples (right)

The recorded measurements for blood samples containing lead are presented in table 3. Analyzing the data, it is observed that the maximum absorbance for the cow blood sample with lead nitrate is at the wavelength of 430 nm. In the case of horse blood sample, the maximum value recorded was at 540 nm. For the dog blood sample containing lead, the maximum absorbance was recorded at 430 nm. In figure 5 are the data for samples with lead.

The absorbance values for samples containing lead

Sample	Wavelength (nm)						
	408	410	412	420	430	450	540
Cow+Pb	2.601	2.745	2.655	2.735	2.794	2.739	2.765
Horse+Pb	2.716	2.248	2.756	2.817	2.869	2.953	3.341
Dog+Pb	2.399	2.401	2.412	2.445	2.461	2.455	2.426

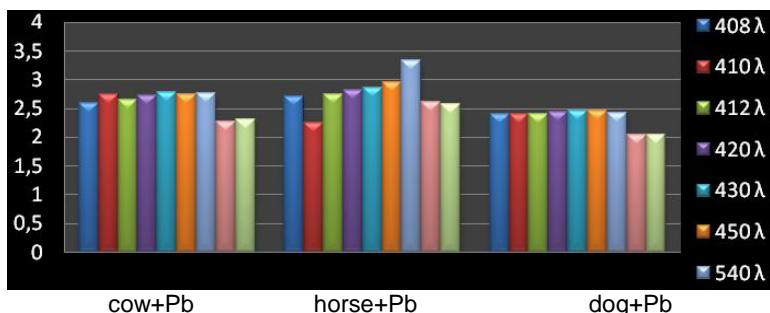


Fig. 5 Dependence of absorption on the wavelength of samples with lead

The comparison of the absorbance values for the two heavy metals in the case of blood collected from horse can be seen in figure 6a.

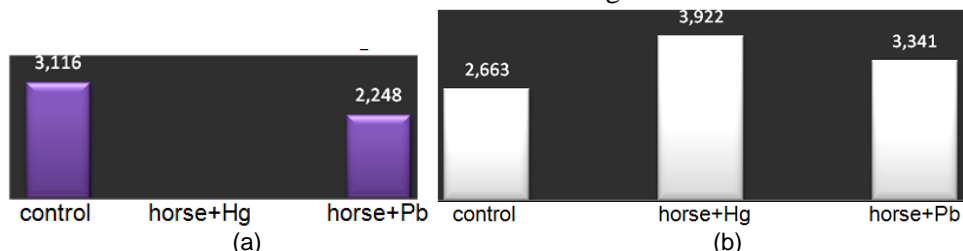


Fig. 6 Absorbance values of oxihemoglobin in horse blood at 410 nm (a) and 540 nm (b)

The absorbance value for horse blood at 540 nm is higher for the samples with mercury and lead than for the control. The sample with mercury has the highest absorbance (fig. 6b).

Regarding the modification of the oxyhemoglobin spectrum for the dog blood samples, at 540 nm, the highest absorbance was recorded for the mercury sample and the lowest value for the lead sample (fig. 7).

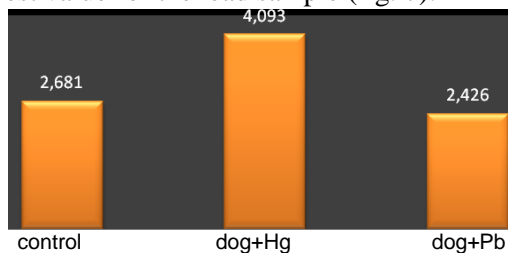


Fig. 7 Absorbance values of oxihemoglobin in dog blood at 540 nm



The weaker effect of lead can be explained by the fact that Pb is a heavy metal less toxic than Hg. Moreover, the blood has been collected on EDTA and this is a specific antidote for Pb. EDTA forms with lead a chelate which is subsequently excreted by the kidneys (Solcan and Chiriac, 2005).

## CONCLUSIONS

Experimental results have shown that heavy metals affect certain biophysical characteristics of hemoglobin in the blood of the studied animals.

From the UV-VIS spectra of oxyhemoglobin was determined that its absorption maxima are at 410, 430 and 540 nm. The strongest effect has been obtained for mercury, which is the most toxic heavy metal. These results are consistent with those obtained by other researchers who claim that heavy metal attaches to the hemoglobin molecule in the blood, altering its structure. The modification produced by mercury was observed immediately, the sample changing its transparency. For the horse blood sample containing mercury, at 410 nm, the absorbance measurement gave an error, indicating that the sample was severely degraded. For the oxyhemoglobin absorption maximum at 540 nm, the absorbance of samples containing mercury is higher than the control, for all three animals studied. Furthermore, the values are higher in the case of samples with mercury than the ones with lead for all three species. The strong effect of mercury can be explained by the bonding of mercury to sulfide bonds (thiol) in the hemoglobin molecule. As for the effect of lead, although it is also a very toxic heavy metal, the effects are weaker.

The effects of heavy metals increase over time, suggesting that the heavy metal action is cumulative.

**Acknowledgments:** This work was supported by the CNCS-UEFISCDI, PN-III-P1-1.1-TE-2016-2336 project.

## REFERENCES

1. Galaris D., Yova D., Korantzopoulos P., Barbounaki S., Koutsouris D., 1995 - *Effects of ascorbic acid on tert-butyl hydroperoxide-induced deformability decrease in human erythrocytes*, Clinical Hemorheology and Microcirculation, 15(1), pp. 107-120.
2. Kummrow F., Silva F., Kuno R., Souza A., Oliveira P., 2007 - *Biomonitoring method for the simultaneous determination of cadmium and lead in whole blood by electrothermal atomic absorption spectrometry for assessment of environmental exposure*, Talanta, 75(1), pp. 246-252.
3. Neathery W., Miller J., 1975 - *Metabolism and Toxicity of Cadmium, Mercury, and Lead in Animals: A Review*, Journal of Dairy Science, 58(12), pp. 1767-1781.
4. Rapa A., Oancea S., 2006 - *Hemoreologie comparată*, Ed. Tehnopress, ISBN 13 978-973-702-404-6.
5. Gwaltney-Brant S., 2013 - *Heavy Metals* in Haschek and Rousseaux's Handbook of Toxicologic Pathology, Third Edition, Elsevier, ISBN 978-0-12-415759-0.
6. Solcan Gh., Beșcea Chiriac S.I., 2005 - *Toxicologie veterinara*, Ed. Tehnopress, ISBN 9737021193.

## ANALYSIS OF PROTEINS CONTENT FROM BLOOD PLASMA OF HERBIVOROUS AND CARNIVOROUS ANIMALS

### ANALIZA CONȚINUTULUI DE PROTEINE DIN PLASMA SANGUINĂ A ANIMALELOR ERBIVORE ȘI CARNIVORE

CAZACU Ana<sup>1</sup>, OANCEA Servilia<sup>1</sup>, BODALE I.<sup>1\*</sup>

\*Corresponding author e-mail: ilie.bodale@uaiasi.ro

**Abstract.** *This paper focuses on determining the concentration of blood plasma proteins for different domestic animals to highlight the link between diet and proteins content. Blood plasma from two categories of animals, herbivores and carnivores (horse, cow, goat, sheep and dog) was used for this study, the protein content being compared to that found in human and turkey blood (omnivorous). Our results showed that the samples of blood taken from dogs have the lowest proteins content, although they consume food rich in proteins. The highest value of proteinemia is found in horse blood, even if it is an herbivorous animal that consumes food rich in fibbers and vitamins. The hypothesis that herbivores have a higher content of proteins in blood than carnivores is supported by the results obtained for samples of cow, goat and sheep blood.*

**Key words:** blood plasma, nutrition, protein content, diet

**Rezumat.** *Această lucrare urmărește determinarea concentrației de proteine din plasma sanguină pentru diferite animale domestice pentru a evidenția legătura dintre alimentație și conținutul de proteine. Pentru acest studiu s-a folosit plasmă sanguină de la două categorii de animale, erbivore și carnivore (cal, vacă, capră, oaie și câine), conținutul de proteine fiind comparat cu cel din sângele de om și curcan (omnivore). Rezultatele noastre au arătat că probele de sânge prelevate de la câine au conținutul cel mai mic de proteine, deși consumă alimente bogate în proteine. Valoarea cea mai mare a proteinemiei se găsește în sângele de cal, chiar dacă este un animal ierbivor care consumă alimente bogate în fibre și vitamine. Ipoteza că erbivorele au un conținut mai mare de proteine în sânge decât carnivorele este susținută de rezultatele obținute pentru probele de sânge de vacă, capră și oaie.*

**Cuvinte cheie:** plasma sanguină, alimentație, proteinemie, dietă

## INTRODUCTION

Blood is a suspension of white and red blood cells in a homogenous liquid called plasma, red blood cells containing hemoglobin, and plasma containing fibrinogen, globulins and albumins (Agre, 1989). The remaining liquid after removing the globules and fibrinogen is called the blood serum. Plasma proteins are a very important biophysical parameter that highlights the normality or pathology of humans and animals. These, in addition to the role of transport, play

---

<sup>1</sup>University of Agricultural Sciences and Veterinary Medicine Iasi, Romania

an important role in protecting the body through the immune system, in the blood clotting process, acts like a buffer in maintaining a constant pH and maintaining a constant osmotic blood pressure (Oancea, 2001; Râpă, 2006). Except immunoglobulins, most plasma proteins are synthesized in hepatocytes.

Most studies on the peculiarities of blood were carried out on human samples. Although many are known about the composition and characteristics of human blood, there is much less information about most animals. Proteins are the main constituents of the animal body, fulfilling a wide variety of functions, and having very different compositions (Dimofache, 1996). The most important characteristic of proteins is the specificity. Vegetable and animal proteins of various species differ one from another, with differences even between the proteins of individuals belonging to the same species. It is estimated that in an animal organism there are about 100,000 specific proteins. Each protein macromolecule is composed of 50 to 10,000 units of  $\alpha$ - amino acids linked by peptide bonds (Wang, 2006).

The study of protein content in different animal species in relation to their normal state and pathological conditions is one of the most approached areas, due to the increase in the sensitivity of the techniques used (Solcan, 2005). In the present study, different protein content for the investigated animals was observed. The blood protein content of some domestic species (horse, cow, goat, dog and turkey) was analyzed by refractometry.

## MATERIAL AND METHOD

The materials used in this study are blood samples from the following species: horse, cow, goat, sheep, dog, turkey, human; which were collected in 6 ml vials with EDTA as anticoagulant. The samples were centrifuged for 3 minutes at 5000 rpm, performing two centrifugations for each sample. Plasma was then isolated in 6 ml Vacutest K3 EDTA vials, at a temperature of 28°C. Using an Abbe refractometer, the refractive index of the plasma samples was determined.

## RESULTS AND DISCUSSIONS

In a first refractometric analysis, the refractive index of blood plasma was determined for the following animal species: cow, goat, and horse (tab. 1 and fig. 1).

Table 1

**Refractive index of the blood plasma of the investigated animals**

Species	Refractive index	Protein concentration (g/dl)
Cow	1.3492	7.69
Goat	1.3467	6.34
Horse	1.34470	5.03

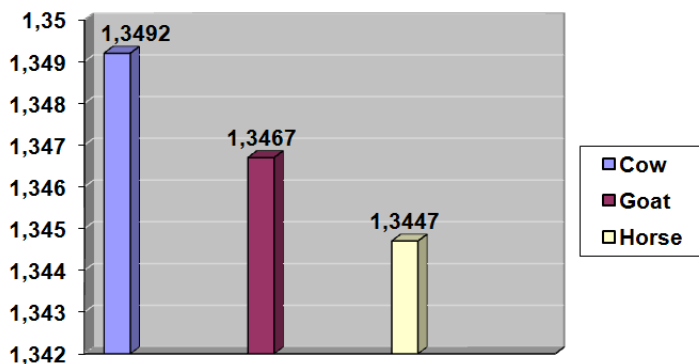


Fig. 1 Refractive index of the plasma for different animals

The above data show the following:

- the refractive index and, therefore, proteinemia is lower for the horse, showing a poor nutrition;
- the proteinemia of the goat is lower than the one of the cow.

Later, plasma proteinemia from the blood of animals (horse, cow, goat) and a bird (turkey) was analyzed. The refractometric determinations were carried out in two different periods of the year. The obtained values of the refractive indices for each individual species are presented in table 2 and figure 2 (for the first period) and in table 3 and figure 3 (for the second period).

Table 2

Refractive index of the blood plasma during the first period

Species	Refractive index	Protein concentration (g/dl)
Horse	1.3494	7.85
Cow	1.3490	7.69
Goat	1.3488	7.42
Turkey	1.3440	4.81

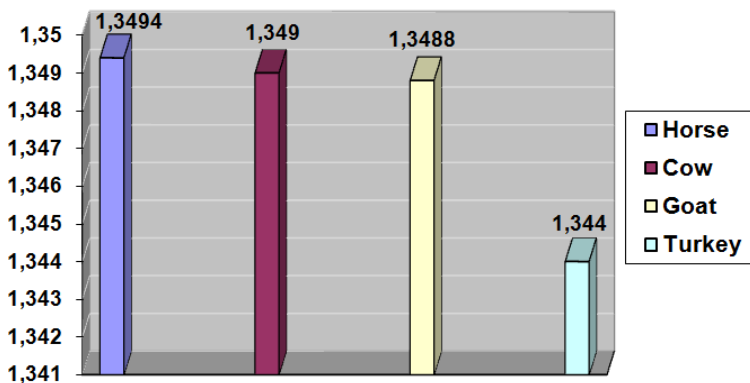
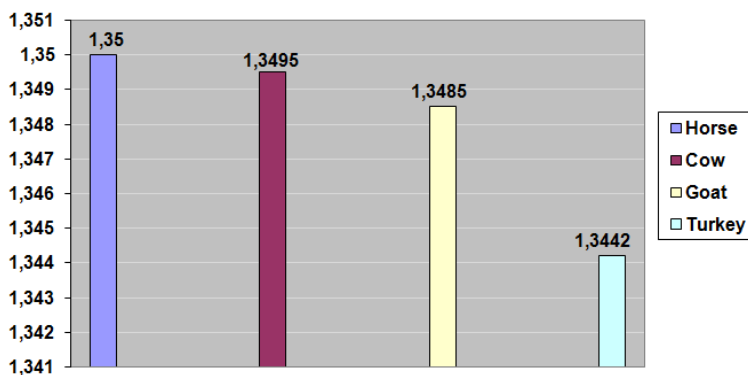


Fig. 2 Refractive index of the plasma for different animals (first period)

Table 3

**Refractive index of the blood plasma during the second period**

Species	Refractive index	Protein concentration (g/dl)
Horse	1.3500	8.22
Cow	1.3495	7.85
Goat	1.3485	7.2
Turkey	1.3442	4.81

**Fig. 3** Refractive index of the plasma for different animals (second period)

Analysing the data presented above it can be observed that:

- the lowest value of the plasma refractive index and proteinemia, respectively, corresponds to the sample of turkey blood;
- close values for cow and goat were obtained;
- the highest value was obtained for horse.

Additionally, a comparison was made with proteinemia in human blood. Thus, blood samples were collected both from a few animal species (cow, horse, sheep, and dog) and from humans (tab. 4 and fig. 4).

Table 4

**Refractive index of the blood plasma of the investigated species**

Species	Refractive index	Protein concentration (g/dl)
Cow	1.3462	5.9
Horse	1.3475	6.77
Sheep	1.3451	5.25
Dog	1.3415	3.28
Human	1.3474	6.77

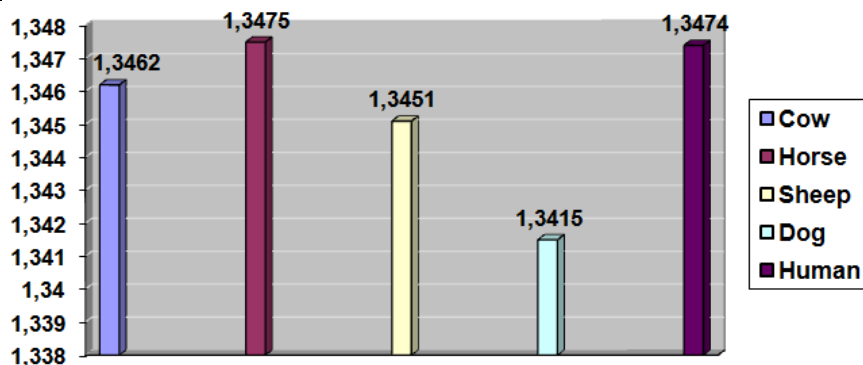


Fig. 4 Refractive index of the plasma for different species

From table 4 it can be noted that:

- the lowest value of protein content, which is correlated with the refractive index, is for the dog;
- proteinemia for humans is equal to that of the horse;
- sheep and cows have similar protein levels;
- the sheep has lower proteinemia, however, compared to cow and goat.

Our results are comparable to those obtained by other authors (Marquez, 2005).

## CONCLUSIONS

We performed comparative refractometric measurements of the protein content of the blood plasma for different domestic animals during four periods in two consecutive years.

The lowest value of the plasma refractive index and proteinemia, respectively, corresponds to the blood sample of turkey, followed by that of the dog blood sample.

The highest value of plasma and protein refractive index corresponds to horse blood sample.

For goat and sheep were obtained close values, which are comparatively lower than the value for cow.

Plasma proteinemia values for horse blood samples were close to those obtained for plasma samples of human blood.

The results obtained in this paper are consistent with those reported by Marquez et al. (Marquez, 2005). For cow, an average proteinemia of 6.8 g/dl was obtained, and in literature, for cattle, it is found a value of 7.21 g/dl. For turkey, a proteinemia of 4.8 g/dl was obtained, while in literature, for poultry, a value of 3.21 g/dl was noted.

The results on proteinemia show that it does not depend on the animal's nutrition, i.e. on the protein content of the food. Thus, although the horse is an herbivorous animal and the dog or the birds are omnivorous, the protein content

for the horse is very high as compared to the dog or the birds. By contrary, when we compare horse and human blood, the results have equal values, despite the fact that the nutrition is quite different.

**Acknowledgments:** This work was supported by the CNCS-UEFISCDI, PN-III-P1-1.1-TE-2016-2336 project.

## REFERENCES

1. **Agre P., Parker J.C., 1989** - *Red blood cell membranes: Structure, Function, Clinical Implications*, Ed. Marcel Dekker, New York and Basel, ISBN 0-8247-8022-1.
2. **Dimofache C., Herman S., 1996** - *Biofizică medicală*, Ed. Cerma, Bucuresti.
3. **Marquez E., Bracho M., Archile A., Rangel L., Benitez B., 2005** - *Proteins, isoleucine, lysine and methionine content of bovine, porcine and poultry blood and their fractions*, Food Chemistry, 93(3), pp. 503–505.
4. **Oancea S., 2001** - *Elemente de Biofizică medicală comparată*, Ed. Tehnopress, Iași, ISBN 973-8048-50-8.
5. **Râpă A., Oancea S., 2006** - *Hemoreologie comparată*, Ed. Tehnopress, Iași.
6. **Solcan Gh., Boghian V., Rollin F., 2005** - *Patologie si clinica medicala veterinara*, Ed. "Ion Ionescu de la Brad", Iași, ISBN 978-973-7921-61-5.
7. **Wang J., Li D., Dangott L.J., Wu G., 2006** - *Proteomics and its role in nutrition research*, Journal of Nutrition, 136(7), pp. 1759-1762.

## VALORIFICATION OF THE ECONOMIC POTENTIAL OF RARAU MASSIF BASED ON CLIMATE CONDITIONS

### VALORIFICAREA POTENTIALULUI ECONOMIC AL MASIVULUI RARĂU PE BAZA CONDIȚIILOR CLIMATICE

**BODALE Ilie<sup>1</sup>, OANCEA Servilia<sup>1</sup>, CAZACU Ana<sup>1\*</sup>**

\*Corresponding author e-mail: anagarlea@gmail.com

**Abstract.** *The Rarau Massif is a mountain area exploited for tourism purposes since 1928, but recent climate change requires a reanalysis of the new weather conditions to propose a new economical capitalizing plan. In this paper we analyzed the main meteorological elements (temperature, precipitation, speed and frequency of wind) recorded by the Rarau meteorological station to highlight the economic potential of the area. In the Rarau massif, the air temperature during the summer months has increased, which is favourable for mountain tourism. This hypothesis is also supported by the decrease of the amount of rainfall during the summer. Our analysis shows that the heating of the air is due to the warm wind, predominantly in the east - west direction with relatively slow speeds (2 m/s). Instead, the temperatures have decreased in January - February which supports the construction of one of the longest winter sports slope in Romania.*

**Keywords:** climate change, sustainable development, Rarau development

**Rezumat.** *Masivul Rarău este o arie montană exploatată în scop turistic din 1928, dar schimbările climatice din ultimul timp impun o reanaliză a noilor condiții meteorologice pentru a propune un nou plan de valorificare economică. În lucrarea de față am analizat principalele elemente meteorologice (temperatură, precipitații, viteza și frecvența vântului) prelevate de la stația meteorologică Rarău cu scopul de a evidenția potențialul economic al zonei. În masivul Rarău, temperatura aerului în lunile de vară a crescut, ceea ce este favorabil turismului montan. Această ipoteză este susținută și de scăderea cantității de precipitații în timpul verii. Analiza noastră arată că încălzirea aerului se datorează vântului cald, preponderent pe direcția est-vest cu viteze relativ mici (2 m/s). În schimb, în ianuarie - februarie temperaturile au scăzut, ceea ce susține construcția unei dintre cele mai lungi pârtii pentru sporturile de iarnă din România.*

**Cuvinte cheie:** schimbări climatice, dezvoltare durabilă, dezvoltare Rarău

## INTRODUCTION

The tourism is a way of capitalizing the natural resources, the climate, the curative qualities of the mineral and thermal waters and in the case of mountain tourism, the beauty of the landscapes during the summer or sports on snow in the winter.

In some tourist areas, the natural environment is the predominant factor that attracts tourists. The natural framework could be threatened by climate change (Ivanescu *et al.*, 2016; Ivanescu *et al.*, 2018), which has as effect the decreasing of number of

---

<sup>1</sup> University of Agricultural Sciences and Veterinary Medicine Iasi, Romania



tourists. In the case of forested mountainous areas, this can have a major impact on the forest vegetations and fauna. That is why, in the last few years, thorough tourism studies take into account the effects of climate change that has become a topic of interest in all important places of the world. The importance of this topic derives from the fact that these climate changes have produced many negative effects on natural ecosystems. Moreover, the climate changes and pollution affect the buildings, statues and wall painted of monuments from historic cities. The tourism sector is the most affected by the heat waves that occur in the warm season, the small amount of precipitation, the decrease of snow persistence during the winter and, especially, by the extreme phenomena such as floods, tornadoes etc (Bodale *et al.*, 2017). Weather factors that have a major impact on tourism are temperature, precipitation and winds.

The Rarau Massif has been exploited for tourism since 1928 by building the Rarau cottage that had a strong contribution for geographic and geological researches and meteorological measurements in this area. After 2014, when the road infrastructure was modernized by building *TransRarău road*, alongside with the accommodation conditions improvement, a new approach is required. The *TransRarău road* ensures auto access in Rarau Massif from Moldova Valley through DJ175B (from Pojorâta side) and from Bistrita Valley (D175A from Chiril side). Furthermore, Suceava County administration is prepared to modernize a new way of access from the east part of Campulung Moldovenesc to the ski slope (DJ175A). Starting from these premises, in this paper, we propose a new climatic bulletin to be included in the future master plan of developing the Rarau tourist area, which should offer a new opportunity for tourists based on analysing the climatic factors.

## MATERIAL AND METHOD

In the present paper, we analyzed the modification of these climatic factors that influence tourism in the Rarau Mountain range, one of the most important tourist area from Moldova. For this purpose, we analysed the temperature, the amount of precipitation, frequency and the speed of wind recorded by Rarau meteorological station during the period 1991-2000 versus the climatologically average of the period 1961–1991. We used statistical processing tools, specialized graphics and presentation programs: Excel and Matlab.

## RESULTS AND DISCUSSIONS

Relief is an important genetic factor of climate that influence the meteorological conditions, especially due to the altitude. This is the main reason why weather in the mountains is more difficult to analyze (Barry, 2008; Oancea, 2010). In general, for population the easiest way to perceive weather is temperature that depends on solar radiation, air circulation, the slope of the relief, the slope exhibition against the sunstroke, which determines the angle of incidence of solar radiation.

The general characteristics of the climate in Rarau should be studied on two levels of altitude. We focused the present study on the upper level that includes the top of the massif from 1200 m to 1650 m. This presents the most important characteristics for

tourism. We analysed the radiation balance in order to understand the thermal characteristics. In the Rarau Massif, the direct sunlight has a peak in June at 12.00 PM. During winter, in December at 12.00 PM, due to the Earth's axis angle only 15 % of direct radiation is recorded. Therefore, the global radiation is minimal in winter's mornings (0.03 cal/cm<sup>2</sup>/min) and maximum at 12.00 PM in summer's days (1.0 cal/cm<sup>2</sup>/min). At high altitudes, the annual maximum value of global radiation is found between 1200 – 1400 m (110 kcal/cm<sup>2</sup>/year) and decreases towards the top of the massif (107 kcal/cm<sup>2</sup>/min). The reflected radiation depends on vegetation, which covers the soil surface. Areas covered by coniferous forests present an average albedo of 10–18 %, while for pastures, the average albedo is of 19–20%. The land surface, absorbs 30% from radiation when is covered by snow and up to 90 % when there is vegetation (Rusu, 2002).

Sunstroke on the northern slope is less (12 %) than on the southern side where it is 14%. However, because of its position, the sunshine is only 51-70% of the total sunstroke as opposed to the southern slope, which is sunny (91–100 %) (Chirita *et al.*, 1977).

Temperature is the most important meteorological element because it influences a series of physical, chemical and biological processes. Moreover, its distribution is more stable than precipitation. Consequently, temperature influences both tourism and human activity, which indirectly influence the tourism.

At the Rarau meteorological station, placed at 1650 m altitude above sea level, the average annual air temperature between 1961–2000 was 2.4 °C and the annual air temperature amplitude was 18.1 °C. The annually average temperature values for the studied period are presented in table 1 and the monthly temperatures average are given in table 2 for the same period.

Table 2 shows that the lowest monthly temperature is in January and the warmest month is July when a temperature of 11.7 °C was recorded at the Rarau meteorological station. In the last decade, the variation of temperature recorded on the Rarau massif is given in figure 1. This figure shows that the monthly lowest temperature is in January (10.1°C) and the highest in August (13°C). In all summer months the temperature is higher than the climatological average.

Table 1

Year	1992	1993	1994	1995	1996	1997	1998	1999	2000
Average of annually temperature (°C)	2.2	1.7	3.2	2.0	1.6	1.5	2.0	3.1	3.6

Table 2

Month	I	II	III	IV	V	VI	VII	VIII	IX	X	XI	XII
Average of monthly temperature (°C)	-7.4	-6.8	-3.6	1.5	6.8	10.1	11.7	11.6	8.2	3.6	-1.3	-5.6

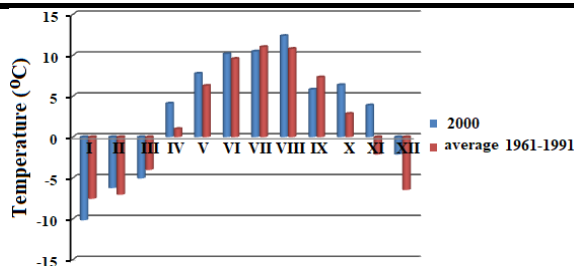


Fig. 1 Monthly temperature in 2000 versus average from 1961-1991 recorded by Rarau meteorological station

Table 3

Annually average precipitation values recorded by Rarau meteorological station from 1992 to 2000

Year	1992	1993	1994	1995	1996	1997	1998	1999	2000
Average of annually precipitation(mm)	861	769.7	463.9	695.8	696.8	668.4	935.7	847.4	776.1

Table 4

Monthly average precipitation values recorded by Rarau meteorological station

Month	I	II	III	IV	V	VI	VII	VIII	IX	X	XI	XII
Average of monthly precipitation (mm)	44.1	42.7	47.0	85.1	136.4	158.9	152.7	116.6	68.9	48.5	41.9	43.1

In terms of precipitations on Rarau Massif, the annually average of rainfall, in mm, is given in table 3 and the average monthly in table 4 from 1992 to 2000.

Table 4 shows that the amount of precipitation during summer months (June and July) is higher than the one in the winter months due to the anti-cyclonic regime, which prevents the formation of the thermal convection. Starting March, the precipitation increases progressively until summer and then gradually decreases. In 2000, the variation of precipitation amount compared to the climatologically norm is given in figure 2. In this figure, there is an oscillation of the rainfall compared to the norms, with the highest rainfall being in August (154.1 mm) and the lowest in November (6.9 mm). This variation is similar to previous years, which shows a reduction for rainfall during the spring and early summer and an increasing in August and September.

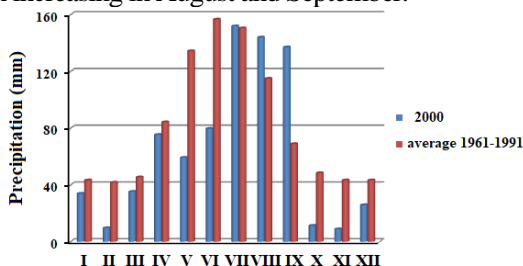
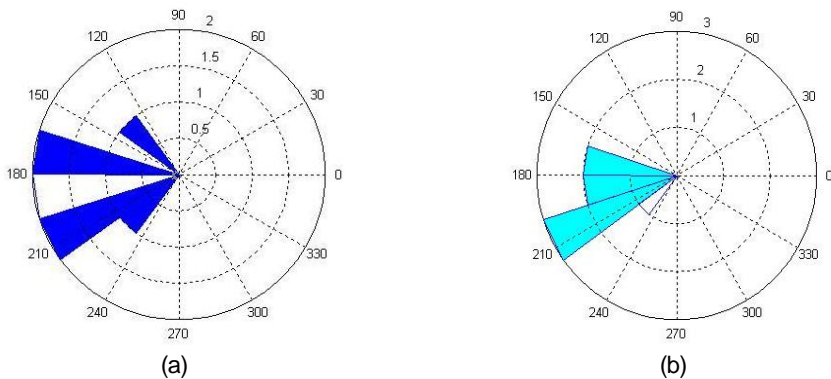


Fig. 2 Monthly precipitation in 2000 versus average from 1961-1991 recorded by Rarau meteorological station

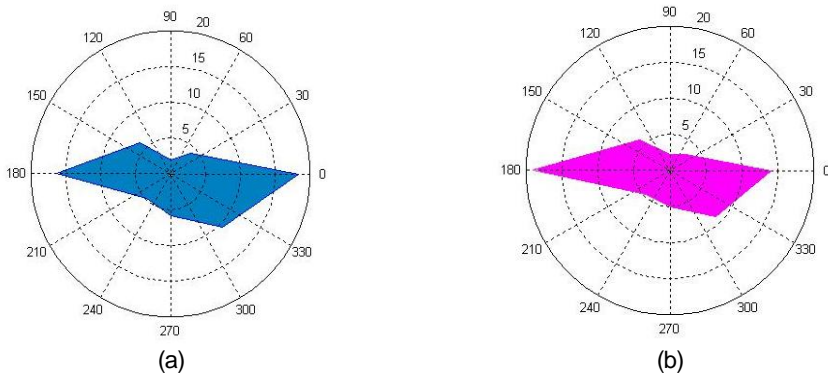
The circulation of air masses in the Rarau Massif is generated firstly by the *western air mass* (45%), which causes mild and wet winters and generates a high degree of instability. Second, the *polar air mass* (30%) in the north-west direction generates temperature drops, increased nebulosity and precipitations in the form of showers. Third, the *tropical air circulation* accounts around 15% of the total circulation of the atmosphere and manifests itself in the south-west direction, producing warming, many precipitations in the cold season and unstable weather in the warm season. Finally, the *blocking air circulation* represents only 10% and is generating stable and warm weather (Rusu, 2002).

Wind is a meteorological element with a great role in balancing the atmospheric contrast and results from the difference in heating of the surface, which tends to balance the pressure in two masses of air. High velocity increases evaporation, while atmospheric calm produces vapour accumulations and uneven heating.

The wind speed in the Rarau Massif during July (around 2 m/s) is shown in figure 3(a), and in figure 3(b) during August (3 m/s). The wind speed is relatively small (fig. 3 a-b). The frequency of the wind in the Rarau Massif during summer is in both directions, from east and west sides (fig. 3 a-b). In July, the predominant wind is from the east (fig. 4a), and from west in August (fig. 4 b).



**Fig. 3** Wind speed recorded by Rarau meteorological station: in July (a) and in August (b)



**Fig. 4** Wind frequencies recorded by Rarau meteorological station: in July (a) and in August (b)

## CONCLUSIONS

1. The monthly and annually temperatures in Rarau Massif are modest, which favours the maintenance of the vegetal and forest carpet. Negative monthly temperatures keep up around 5 months per year, but we can notice in the last decade a slight increase in temperature.

2. In the case of precipitation, there is a significant decrease in relation to climatological average, which shows that tourism is encouraged in the summer months.

3. During winter, it is observed a temperature decreasing that is beneficial for tourism, given an opportunity to build one of the longest ski slopes from Romania for practicing winter sports in the area on northern slop of massif. In winter, the snow layer is maintained at 40-50 cm.

4. In the Rarau Massif, below 10 meters in the atmosphere, the winds appear from the east and west direction with a relatively small speed, around 3 m/s.

5. Our results show that the summer months are best suited for tourism, having optimal temperatures for outdoor activities (balneal treatment, walks, camping or wildlife watching). Lack of wind also favours such activities. Moreover, winter sports can be practiced with great success in the frozen season.

**Acknowledgment:** This work was supported by the CNCS-UEFISCDI, PN-III-P1-1.1-TE-2016-2336 project.

## REFERENCES

1. Barry R., 2008 - *Mountain weather and Climate*, 3th edition, Cambridge University press,
2. Bodale I., Cazacu A., Enea E., Oancea S., 2017 - *Increasing the risk of tornadoes in Romania due to climate change*, *Lucrări științifice USAMV Iași, Seria Horticultură*, 60(2), p. 345-350.
3. Chiriță C., Vlad I., Păunescu. C., Pătrășcoiu N., Roșu C., Iancu I., 1977 - *Stațiuni forestiere*, vol II, Editura Academiei, București.
4. Ivanescu L., Bodale I., Florescu S., Roman C., Acatrinei D., Miron L., 2016 - *Malaria a high risk of re-emergence in Romania*, *BioMed Research International*, 2016, ID 8560519, p. 1-7.
6. Ivanescu L., Bodale I., Florescu S., Roman C., Acatrinei D., Campan A., Miron L., 2018 - *Global warming is increasing the risk of reemergence of malaria in Romania*, 7th GCGW Conference proceeding, Chapter 4. Climate change:causes, impacts and models, p. 138-140.
7. Oancea S., 2010 - *Despre atmosferă, vreme și climă*, Editura PIM, Iași.
8. Rusu C., 2002 - *Masivul Rarău. Studiu de geografie fizică*, Editura Academiei, București.
9. \*\*\* 1983 - *Geografia României*, Vol I. Editura Academiei, București.
10. \*\*\* 1987 - *Geografia României*, Vol II. editura Academiei, București.

## STUDY OF CAPILLARY HYSTERESIS IN MEDIUM TEXTURE SOIL USING PREISACH MODEL

### STUDIUL HISTEREZISULUI CAPILAR ÎN SOLURI CU TEXTURA MEDIE FOLOSIND MODELUL PREISACH

**BODALE Ilie<sup>1</sup>, CAZACU Ana<sup>1\*</sup>**

\*Corresponding author e-mail: anagarlea@gmail.com

**Abstract.** *The purpose of this paper is to study the physical properties of the soil using a phenomenological model which should be able to describe the capillary hysteresis of water from pores of the medium-textured soil. The proposed model is Preisach type and has been used successfully to describe the hysteresis of nonlinear phenomena in physics, biology or economics. This model has the advantage of being easily adapted. We had expanded this model to study the pressure exerted by water in the processes of drying and wetting of the soil. The developed and implemented model, unlike other models, takes into consideration the way in which interconnected pores are filled and emptied. Our study presents a new method of assessing the water circulation in soil pores with medium texture from greenhouses. The results are useful to make the irrigation systems used in gardening more efficient, from economical point of view.*

**Keywords:** drying-wetting process, water hysteresis, Preisach model, irrigation

**Rezumat.** *Scopul acestei lucrări este de a studia proprietățile fizice ale solului utilizând un model fenomenologic capabil să descrie histerezisul apei din porii capilari ai solului cu textură medie. Modelul propus este de tip Preisach, fiind folosit cu succes pentru a descrie histerezisul fenomenelor neliniare din fizică, biologie sau economie. Acest model prezintă avantajul de a putea fi ușor adaptat. Noi am extins acest model pentru a studia presiunea exercitată de apă în procesele de uscare și umezire ale solului. Modelul dezvoltat și implementat, spre deosebire de alte modele, ia în considerare modul de umplere și golire al porilor în cazul în care aceștia sunt interconectați. Studiul nostru prezintă o nouă metodă de evaluare a circulația apei în porii solului cu textură medie din sere. Rezultatele sunt utile pentru a eficientiza, din punct de vedere economic, sistemele de irigații utilizate în grădinarit.*

**Cuvinte cheie:** procesul de uscare-umezire, histerezisul apei, modelul Preisach, irigare

---

<sup>1</sup> University of Agricultural Sciences and Veterinary Medicine Iasi, Romania

---

## INTRODUCTION

The soil is described as a porous medium where all the phases (liquid, solid and gas) coexist and presents a memory effect in unsaturated state. The memory effect is highlighted by hysteresis loop. In soil, it is important to know the relationship between capillary pressure and saturation to understand the unsaturated behavior of this type of system. Water-soil characteristic curves (WSSC) have been used to estimate the hydraulic conductivity, pores volume variation, shears strength or diffusion phenomena in soil.

The hysteretic behavior of soil is given by a sum of factors, the most important being the irregular pore space geometry, a different contact angle for the two directions of water content evolution, the air entrapped inside the medium, the shrinking and swelling of pores (Nimmo, 2006), and the thermal effect.

- The ‘ink bottle effect’ is the effect given by geometric non-uniformity of individual pores when the water passes the smallest cross-sections of pores.
- The variation of contact angle between advancing interface (wetting of pore) and receding (drying of pore) is described by unequal values. The advancing angle is larger than the receding one, thus the suction at drying is greater than the wetting.
- The proportion of liquid and gas of soil is inverted when the state of pore is changed. If the liquid phase is dominant in pores, then the air trapped inside slows pore filling.
- In fine grained medium, the swelling of pore due to wetting and shrinkage due to drying changes the diameter of pores.
- The variation of temperature affects the retention relation by changing the fluid viscosity and density.

In the last five decades, the science community has been developed numerous models widespread used for water retention estimation in soil. For a model to be useful, it should satisfy three conditions: to respect the law of water mass conservation, to respect Darcy's law regarding the flow of water through a porous medium and to describe relationship between water content and pressure head.

Therefore, these models have been categorized into *conceptual* and *empirical* models. These theories are based on domain theory of capillary hysteresis that can be *independent* and *dependent*. The domain theory takes into account the small area of pores that have the same state.

An *independent* model considers the pore as a single component (mono-domain) that is filled with water or air and cannot be influenced by the surrounding pore state. On the contrary, in the *dependent* model the pores are connected by small tubes creating a network of pores, in the same way like in the percolation theory (Bollobás and Riordan, 2006).

Recently, a mathematical approach of Preisach model was developed in a series of papers in order to simulate the experimental curves of water soil retention (Krejci *et al.*, 2012). This type of model is using the domain theory, where each domain exists in one of the two states: empty or filled with water.

In real porous medium, the pores go through partially full state in wetting or drying processes. The processes in intermediary states are considered as reversible process. Those are associated with instantaneous exchange and linear variation of head pressure. The reversible processes do not depend on the history of water content, only on the actual value of it (Bodale *et al.*, 2011). Instead, the irreversible processes are given by internal variable that are associated with the dissipation of energy. For example, the processes occurring at the two bottleneck of pore are irreversible (Iwata *et al.*, 1994). These processes depend on moisture ‘history’ of porous medium (soil).

In this paper we adapted a Preisach model that includes the transition states and the jumps of state pores in order to describe the water circulation in real soil pores.

### MATERIALS AND METHOD

The classical Preisach model was developed by Mayergoyz (2003) based on Preisach formalism (1935) in order to describe the hysteresis behavior. Initially, their model explained the hysteresis behavior of standard samples of ferromagnetic medium, but it was easily extended to describe all systems with a hysteresis behavior (materials engineering, electrical engineering, geology, biology, economy and water cycle in porous medium as soil).

In this model each element is in one of the two states: empty (filled with air) or full (water flooded) state. The transition of pore between one state to the other depends on the moisture history described by a small hysteresis, named hysteron. The sum of all hysterons of a system is given by the hysteresis of the whole system.

In the Preisach model, each hysteron has a single point associated in half Preisach plan where the coordinates  $((f, d); f = \text{filling}, d = \text{draining})$  are the pore switching values on wetting and on drying processes, respectively. In Preisach plan area, which has physical signification, it is described by a right triangle (Fig. ) limited by the first bisector and the two extremely lines: no water ( $x$ ) and saturation ( $x_{\max}$ ). In a porous medium, the pores are not identical according to the switching values and can be described by two statistically independent distributions. The product of the two distributions gives the Preisach distribution that is found in the triangle area from Preisach plan (Bodale and Stancu, 2013):

$$p(f, d) = p(f) \cdot p(d) \tag{1}$$

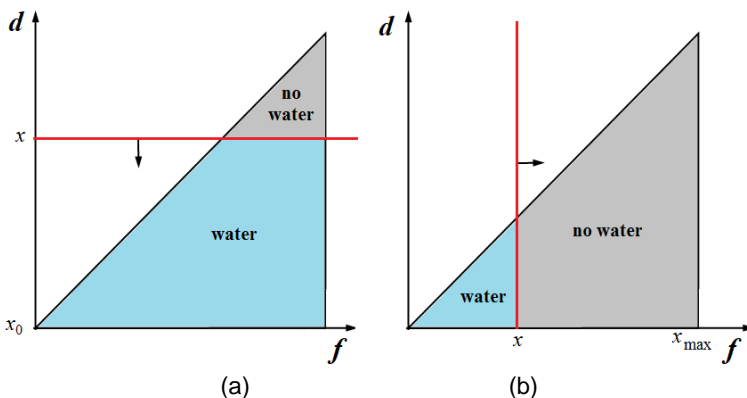


Fig. 1 The Preisach plan swept by  $x$  for (a) drying and (b) wetting processes.



The main drying curve (MDC) is obtained starting from the *saturate state* (where all pores are filled with water and no bubbles air entrapped inside) towards complete dry medium ( $x_0$ ). The line of actual value of water content moves down in Preisach plan (fig.1a) and all points with  $d$  value smaller that water content value switches into dry state. This moving down of the line is determined by hydrologic continuous movement of water caused by infiltration, desorption, evaporation and drainage. On the other hand, main wetting curve (MWC) is obtained starting from *no water state* and  $x$  swept of the Preisach plan from left to right (fig. Fig. 1b). The increasing of water content from porous medium is determined by infiltration, surface runoff, irrigation/precipitation, suction and condensation.

The model is based on the integration of Preisach distribution ( $p(f,d)$ ) into the two regions of Preisach plane:

$$I = \left[ \iint_{S_w} p(f,d) df dd - \iint_{S_{now}} p(f,d) df dd \right] \quad (2)$$

In moisture hysteresis or capillary hysteresis from porous media not all situations satisfy the two properties because there is a *pumping effect*, mainly generated by the thermal effect (Wei and Dewoolkar, 2006). This aspect is not the topic of the present paper and will be the subject of a future paper.

In order to take into account all characteristics of porous medium behavior given by jumps and the intermediary states of pores we used generalized Preisach model (GPM) that include reversible and irreversible processes (Stoleru *et al.*, 2010).

The reversible variation ( $R$ ) is determined similarly to equation (2) as a difference of the two intervals of reversible distribution  $p_{rev}(x_{rev})$ :

$$R = \left[ \int_{C_w} p_{rev}(x_{rev}) dx_{rev} - \int_{C_{now}} p_{rev}(x_{rev}) dx_{rev} \right] \quad (3)$$

In generalized type models, the irreversible and reversible weights are defined by a squareness factor ( $S$ ) of hysteresis (Mayergoyz and Friedman, 1988). The proportion between the two components is calculated using:

$$Y = S \cdot I + (1 - S) \cdot R \quad (4)$$

In literature this model was developed in an advanced version, but we used this version because is able to explain the water circulation in medium texture soil.

## RESULTS AND DISCUIONS

We used the above phenomenological model to simulate the water circulation in soil during both processes; drying and wetting based on a set of experimental data published by Morrow and Harris in (1965).

In our simulation, the irreversible process from soil pores was performed using Preisach distribution obtained as a multiply of two Gaussian distributions. Moreover, the squareness factor of hysteresis behavior of experimental data shows a significant reversible component ( $S=0.75$ ). The reversible component was evaluated as initial slopes in starting point of each experimental scanning curves. We identified the reversible component as a Gaussian function obtained by interpolation of experimental values (fig. 2), as in the equation below:

$$f_{rev} = f_0 + A_{rev} \cdot e^{-\frac{(x-\mu_{rev})^2}{2\sigma_{rev}^2}} \quad (5).$$

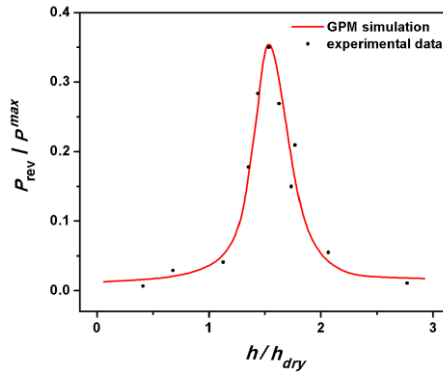


Fig. 2 Reversible distribution identified from experimental data

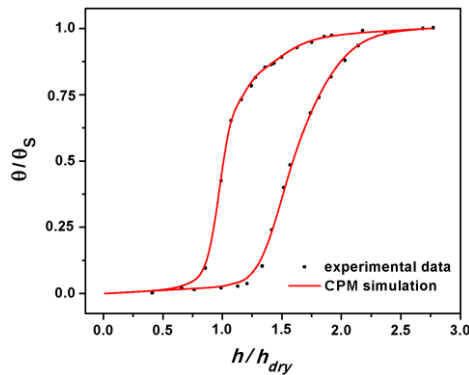


Fig. 3 Simulation of soil-water hysteresis branches by using Preisach model vs. experimental data (Morrow and Harris, 1965)

We used the above Preisach model in order to simulate the behavior of water circulation in the interconnected pores. As is shown in figure 3, the simulated results fit the experimental points (continuous red lines) only if the model includes the reversible process during water movement and if the interconnectivity of pores is considered. By including in Preisach model the reversible variation of water as a Gaussian function (fig. 2), the errors of simulation decreased with 23%.

In order to compare the simulations with the experimental results, we normalized the water content ( $\theta$ ) from soil at the saturation water value ( $\theta_s$ ) and the current pressure head of water ( $h$ ) at the pressure head of water, since most pores jump from a filled to empty state ( $h_{dry}$ ). The reversible probability was normalized at the maximum value of probability distribution identified in the experimental data.

The above results were used to evaluate the available water of soil as difference between field capacity and wilting point. Understanding the physical mechanism by which the water fills the pores or not is an important aspect in order to evaluate the available water of soil necessary to improve water efficiency of irrigation.

## CONCLUSION

1. In soil with medium texture cannot be ignored the effect of unsaturated pores because it influences the shape of water characteristics curves. This effect can be explained only by adding in model the reversible variation of water during filling and drying processes.

2. A good technique to identify the reversible component is based on the geometrical evaluation method of the scanning curves initial slopes which show nonzero values.

3. From the water consumption point of view, the results are useful for designing more efficient irrigation systems to be used in soils with medium texture from greenhouses and gardening.

**Acknowledgment:** This work was supported by the CNCS-UEFISCDI, PN-III-P1-1.1-TE-2016-2336 project.

## REFERENCES

1. **Bodale I., Stoleriu L., Stancu A., 2011** - *Reversible and irreversible components evaluation in hysteretic processes using first and second-order magnetization curves*, IEEE Transactions on Magnetics, 47(1): pp. 192-197.
2. **Bodale, I., Stancu A., 2013** - *Reversible magnetization processes evaluation using high-order magnetization curves*, IEEE Transactions on Magnetics, 49(9): pp. 4960-4964.
3. **Bollobás B., Riordan O., 2006** – *Percolation*, Cambridge University Press, UK.
4. **Iwata S., Tabuchi T., Warkentin B., 1994** - *Soil-water interactions: Mechanisms applications, hardcover, soils, plants and the environment*, 2nd edition, CRC Press
5. **Krejci P., O’Kane P., Pokrovskii A., Rachinskii D., 2012** - *Properties of solutions to a class of differential models incorporating Preisach hysteresis operator*, Physica D: Nonlinear Phenomena, 241: pp. 19.
6. **Mayergoyz I., Friedman G., 1988** - *Generalized Preisach model of hysteresis*, IEEE Transactions on Magnetics, 14(2): pp. 212–217
7. **Mayergoyz I., 2003** - *Mathematical models of hysteresis and their applications*, Academic press, Elsevier, 1: pp.475.
8. **Morrow N.R., Harris C.C., 1965** - *Capillary equilibrium in porous materials*, Society of Petroleum Engineers Journal, 5(1): pp. 15–24.
8. **Nimmo J.R., 2006** - *Unsaturated zone flow processes*, *Encyclopedia of hydrological sciences*, John Wiley & Sons press, USA.
9. **Preisach F., 1935** - *Über die magnetische nachwirkung*, Zeitschrift für Physik, 94: pp. 277-302.
10. **Stoleriu L., Bodale I., Apetrei A., Stancu A., 2010** - *Realistic reversible magnetization component in Preisach-type models*, IEEE Transactions on Magnetics, 46(6): pp. 2341-2344.
11. **Wei C., Dewoolkar M., 2006** - *Formulation of capillary hysteresis with internal state variables*, Water Resources Research, 42(W07405): pp. 1-16.

## THE SPECTROPHOTOMETRIC ANALYSIS METHOD OF METAMIZOLE FROM PHARMACEUTICAL TABLETS: INVESTIGATION OF LINEARITY, LIMIT OF DETECTION AND LIMIT OF QUANTIFICATION

### METODA DE ANALIZĂ SPECTROFOTOMETRICĂ A METAMIZOLULUI DIN TABLETELE FARMACEUTICE: INVESTIGAREA LINEARITĂȚII, A LIMITEI DE DETECȚIE ȘI A LIMITEI DE CUANTIFICARE

CHIRUȚĂ C.C.<sup>1</sup>, GAVĂȚ C.C.<sup>2</sup>, VASILESCU L.V.<sup>2</sup>, EARAR K.<sup>3</sup>, TROFIN  
Alina Elena<sup>1</sup>, TRINCĂ Lucia Carmen<sup>1</sup>, MĂRCULESCU Afrodita Doina<sup>2</sup>

\*Corresponding author e-mail: lctrinca@uaiasi.ro

**Abstract.** The aim of this research was to exactly quantify the pure sodium metamizole content from pharmaceutical tablets, by using a spectro-photometric analysis method in visible range. The method applied has been subjected to a validation protocol which consisted in analyzing the following parameters: linearity of the method, limit of detection (LD) and limit of quantification (LQ). The pure sodium metamizole amount in a pharmaceutical tablet was found to be 477.477 mg, assigned to a percentage content of 95.495 %, close to official declared amount (500 mg), presenting an average percentage deviation of 4.505 % from the officially stated active substance content. This value was situated below the maximum admissible percentage deviation of active substance content ( $\pm 5\%$ ), stated by Romanian Pharmacopeia, X<sup>th</sup> Edition.

**Key words:** sodium metamizole, linearity, detection limit, quantitation limit

**Rezumat.** Lucrarea și-a propus să cuantifice conținutul de metamizol de sodiu pur din tabletele farmaceutice, utilizând o metodă de analiză spectrofotometrică în domeniul vizibil. Metoda aplicată a fost supusă unui protocol de validare care a constat în determinarea următorilor parametri: linearitatea metodei, limita de detecție (LD) și limita de cuantificare (LQ). Cantitatea de metamizol de sodiu pur determinată într-o tabletă farmaceutică a fost de 477,477 mg, corespunzător unui conținut procentual de 95,495%, cu o deviație medie de 4,505% față de conținutul de substanță activă declarat oficial (500 mg), valoare sub deviația procentuală maxim admisibilă a conținutului de substanță activă ( $\pm 5\%$ ) stabilit prin normele din Farmacopeea Română, Ediția a X<sup>-a</sup>.

**Cuvinte cheie:** sodiu metamizole, linearitate, limită de detecție, limită de cuantificare

## INTRODUCTION

Metamizole (sodium salt of dipyron) is a popular analgesic medicine, non-opioid drug, commonly used in human and veterinary medicine. Apart from its

1 University of Agricultural Sciences and Veterinary Medicine Iasi, Romania

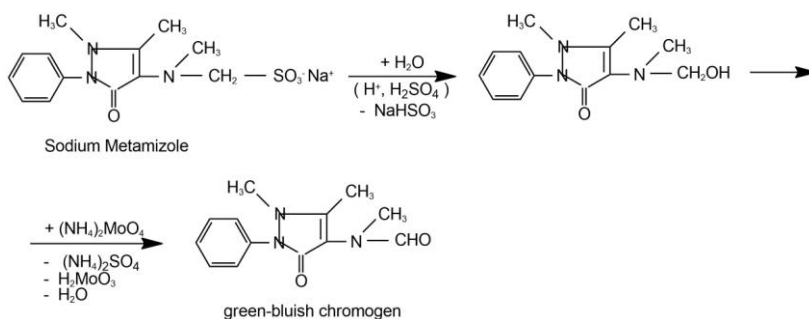
2 “Gr. T. Popa” University of Medicine and Pharmacy Iasi, Romania

3 “Dunarea de Jos” University of Galati, Romania

strong analgesic effect, the medication is a moderate antipyretic and significant spasmolytic agent (Farmacopeia X 1993; Nita *et al.*, 2018). The spasmolytic effect of metamizole is a result of mechanism associated with a powerful inhibition of intracellular calcium ( $\text{Ca}^{2+}$ ) release, as a result of the reduced inositol phosphate synthesis. Metamizole is predominantly applied in the therapy of pain of different etiology, of spastic conditions, especially affecting the digestive tract, as well as of the refractory fever to other treatments. It is especially indicated as a strong, effective analgesic in all types of moderate and intense pain (neuralgia, arthralgia, myalgia, headache, dysmenorrhea), including postoperative pain, renal and biliary colic, dental pain (Jasiecka *et al.*, 2018; Brune *et al.*, 2010; Chandrasekharan *et al.*, 2002).

## MATERIAL AND METHOD

Sodium metamizole was oxidized by 5.0 % ammonium ortho-molybdate  $(\text{NH}_4)_2\text{MoO}_4$  aqueous solution in a strongly acidic medium ( $\text{H}_2\text{SO}_4$ , 40%), to form a bluish-colored green compound (fig. 1), with a maximum absorption at  $\lambda = 690 \text{ nm}$  (Dorneanu *et al.*, 2003, Dorneanu *et al.*, 2007).



**Fig. 1** Chemical reactions of sodium metamizole assigned of green-bluish chromogen

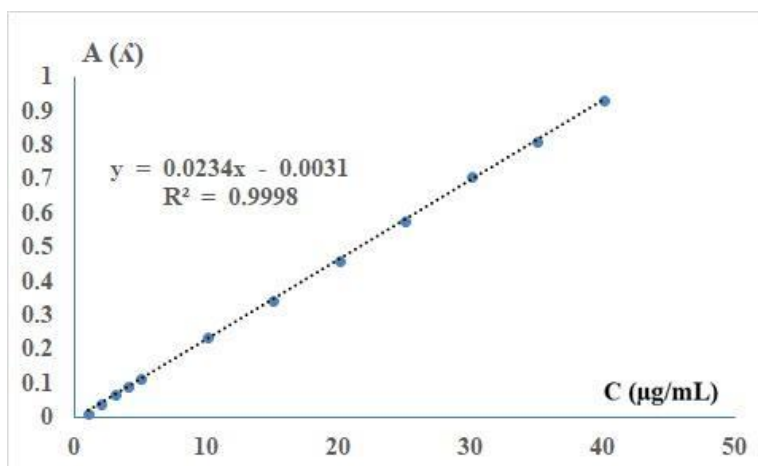
Three pharmaceutical tablets containing metamizole as active substance, with the average mass of 0.5333 g/tablet and official declared 500 mg pure sodium metamizole/tablet, were crushed and the obtained powder (0.1102 g) was quantitatively brought with a little volume of absolute methanol (8 mL) into a  $V_1 = 100 \text{ mL}$  volumetric flask. The content was mixed until complete dissolution of sodium metamizole and filled up to the mark with distilled water. From the obtained sample solution,  $v_1 = 0.4 \text{ mL}$  were measured and quantitatively brought to 10 mL graduated glass tube. Then, 1.5 mL of ammonium ortho-molybdate  $(\text{NH}_4)_2\text{MoO}_4$ , 5.0 % and 0.5 mL  $\text{H}_2\text{SO}_4$ , 40% were added. Sample solution was stirred well, stored in a dark place for 30 minutes and filled up to volume  $V_p = 10 \text{ mL}$  with distilled water. The mean absorbance (Ap) of five measurements was calculated.

Linearity is the method's ability to obtain test results, which are directly proportional to the concentration of analyte in the sample (Roman *et al.*, 1998). Practically, the intensity of the measured absorbance was directly proportional with the concentration between (1-40)  $\mu\text{g/mL}$ . The statistic parameters (Boiculescu *et al.*, 2007) characterizing the method linearity were determined, by using Microsoft Office Excel 2016 software.

Limit of detection (LD) is the smallest amount of analyte that could be detected in a sample as compared to a blank (Banjare *et al.*, 2013; Bhalani *et al.*, 2015; Mubeen *et al.*, 2009) under the same experimental conditions. Limit of quantification (LQ) is given by the lowest analyte concentration in a sample, that could be quantified (determined) with acceptable precision and accuracy (Muñoz *et al.*, 2015) under the same experimental conditions.

## RESULTS AND DISCUSSIONS

Evaluation of sodium metamizole pure amount was based on the established regression plot line, presented in figure 2.



**Fig. 2** Regression plot line of sodium metamizole standard solutions

By replacing  $y$  with the  $A_S$  (absorbance of the sample) and  $x$  with  $C_S$  (concentration of the sample) in the regression line equation  $y = 0.0234x - 0.0031$ , (Fig. 2), it will result:  $A_S = 0.0234C_S - 0.0031$  and thus the concentration ( $\mu\text{g/mL}$ ) of the sodium metamizole solution may be calculated according to equation 1:

$$C_S(\mu\text{g/mL}) = (A_S + 0.0031) / 0.0234 \quad (1),$$

whereas  $C_S$  is the concentration of the sample and  $A_S$  is the absorbance of the sample.

According to the manufacturing company, a pharmaceutical tablet should contain 500 mg of pure sodium metamizole. The amount of pure sodium metamizole existing in the final volume ( $V_P$ ) was determined according to equation 2:

$$X = C_S/V_P \quad (2),$$

whereas  $V_P = 10$  mL is the final volume of the sample solution.

The quantity of pure sodium metamizole from  $V_1 = 100$  mL was determined according to equation 3:

$$X_1 = (V_1 \cdot X) / v_1 \quad (3),$$

whereas  $v_1 = 0.4$  mL is the volume of sample solution measured from the volumetric flask and quantitatively brought to  $V_p = 10$  mL graduated test tube.

The amount of pure sodium metamizole in a pharmaceutical tablet was determined according equation 4, as follows:

$$Y_1 = (m_c X_1) / a \quad (4),$$

whereas  $a = 0.1102$ g is the quantity of powder sample prepared from the pharmaceutical tablets.

The content of pure sodium metamizole in the commercial tablet was calculated according to equation 5:

$$Z (\%) = Y_1 / 5 \quad (5),$$

whereas  $Y_1$  is the amount of pure sodium metamizole, expressed as mg pure sodium metamizole/tablet.

The values of mean absorbance of the solution containing sodium metamizole, with concentration expressed in  $\mu\text{g/mL}$ , as well as the amount of pure sodium metamizole from a pharmaceutical tablet, are presented in table 1.

Table 1

**Mean absorbance value, the corresponding concentration ( $\mu\text{g/mL}$ ) of metamizole solution and the amount of metamizole from a pharmaceutical tablet**

Mean absorbance value	$C_s$ ( $\mu\text{g/mL}$ )	Amount of sodium metamizole(mg) /tablet
0.9204	39.466	477.477

Evaluation of sodium metamizole pure amount represented 95.495% from the value of 500 mg officially declared by the pharmaceutical company, thus the average percentage deviation of 4.505% from the officially declared content content, was within the allowance limit of variance (Table 2) according to the Romanian Pharmacopeia, X<sup>th</sup> Edition.

Table 2

**Maximum allowed percentage deviations from the stated content of active substance in pharmaceuticals stated by Romanian Pharmacopeia, X<sup>th</sup> Edition**

Declared content of active substance	Maximum accepted percentage deviations
up to 10 mg	$\pm 10 \%$
10 mg and up to 100 mg	$\pm 7.5 \%$
100 mg and over 100 mg	$\pm 5 \%$

The main statistic parameters used to evaluate the method linearity are presented in table 3. The resulted regression line equation was:  $y = 0.0234.x - 0.0031$ , or  $A_S(\lambda) = 0.0234C_S (\mu\text{g/mL}) - 0.0031$ . A strength correlation coefficient as well as a strength linear regression coefficient should be  $> 0.999$  (Kapil Kalra, 2011; Aboud *et al.*, 2017). Linear regression coefficient being above minimum admissible value were within the normal range of values.

Table 3

Statistic values of linear regression parameters

Regression Statistics Coefficients	Value
Multiple R (Correlation coefficient)	0.999898
R Square $R^2$ (Linear regression coefficient)	0.999795
Adjusted R Square $R^2$	0.999775
Standard Error (SE)	0.004882
Determinations	12

Limit of detection (LD) was expressed in the same units as the concentration of the analyte ( $\mu\text{g/mL}$ ), being calculated according to equation (6):

$$LD = 3 SE / \text{slope} \quad (6),$$

whereas SE is the standard error of the regression line.

Limit of quantification (LQ) was calculated according to equation (7), being expressed in the same units as the concentration of the analyte ( $\mu\text{g/mL}$ ):

$$LQ = 10 SE / \text{slope} \quad (7),$$

whereas SE is the standard error of the regression line.

The limit of detection (LD) was determined as being  $LD = 0.626 \mu\text{g/mL}$ , while the limit of quantification (LQ) was determined as being  $LQ = 2.086 \mu\text{g/mL}$ .

## CONCLUSIONS

The visible spectrophotometric analysis method used for the evaluation of sodium metamizole in the pharmaceutical tablets was linear for the concentrations ranging between 1– 40  $\mu\text{g/mL}$ , with a strength linear regression coefficient ( $R^2 = 0.999795$ ) and correlation coefficient ( $R = 0.999898$ ).

Standard error of the regression line ( $SE = 0.004882$ ), limit of detection ( $LD = 0.626 \mu\text{g/mL}$ ) and limit of quantification  $LQ = 2.086 \mu\text{g/mL}$  were located within the normal range of values.

Visible spectrophotometric method used for quantitative analysis of sodium metamizole in pharmaceutical tablets was successfully validated to be applied in the practice of metamizole dosage from different samples.



## REFERENCES

1. **Aboud K., Mohammad A., Isbera M., Beesh M., 2017** - Development and Validation Uv Spectrophotometric Method for Determination of Atenolol In Pure Materials And Pharmaceutical Dosage. *Indo American Journal of Pharmaceutical Research*, 7(4), p. 8179-8184
2. **Banjare L., Chandra J.K., Patel P., 2013** - *Method development and validation for estimation of irbesartan in bulk drug and pharmaceutical dosage*. *Journal of Drug Delivery and Therapeutics*, 3(6), p. 87-90.
3. **Bhalani M., Subrahmanyam E.V., Shabaraya A.R., 2015** - *New Analytical Methods and Their Validation for the Estimation of Etodolac in Bulk and Marketed Formulations*. *Int. J. Pharm. Sci. Res.*, 6(2), p. 414-6.
4. **Boiculese L., Dimitriu G., Moscal, M., 2007** - *Elemente de Biostatistica – Analiza statistica a datelor biologice*, Edit. PIM, Iasi, p. 135-156.
5. **Brune K., Renner B., Hinz B., 2010** - *Using pharmacokinetic principles to optimize pain therapy*. *Nature Reviews Rheumatology*, 6(10), p. 589-598.
6. **Chandrasekharan N.V., Dai H., Roos K.L., Evanson N.K., Tomsik J., Elton T.S., Simmons D.L., 2002** - *COX-3, a cyclooxygenase-1 variant inhibited by acetaminophen and other analgesic/antipyretic drugs: cloning, structure, and expression*. *Proceedings of the National Academy of Sciences*, 99(21), p. 13926-31.
7. **Dorneanu V., Stan M., 2007** - *Metode Chimice si Instrumentale de Analiza*, Edit. UMF "Gr.T.Popa", Iasi, p. 236-332.
8. **Dorneanu V., Stan M., Musteata M.F., 2003** - *Chimie Analitică*, Edit. U.M.F. "Gr.T. Popa", Iasi, p. 164-500.
9. **Jasiecka A., Maślanka T., Jaroszewski J.J., 2014** - *Pharmacological characteristics of metamizole*. *Polish Journal of Veterinary Sciences*, 17(1), p. 207-14.
10. **Kapil K., 2011** - *Method Development and Validation of Analytical Procedures, Quality Control of Herbal Medicines and Related Areas*, Prof. Yukihiko Shoyama (Ed.), ISBN:978-953-307-682-9, InTech, p. 86-164
11. **Mubeen G., Prakash V., Somashekar P.L., Uvesh K., 2009** - *Spectrophotometric method for determination of ornidazole*. *Int. J. ChemTech. Res.*, 1, p. 318-21.
12. **Muñoz J., Navarro C., Noriega V., Pinardi G., Sierralta F., Prieto J.C., Miranda H.F., 2010** - *Synergism between COX-3 inhibitors in two animal models of pain*. *Inflammopharmacology*, 18(2) p. 65-71.
13. **Nita A., Tit D.M., Copolovici L., MELINTE C.E., Copolovici D.M., Bungau S., Iovan C., 2018** - *HPLC-UV Method for Determination of Famotidine from Pharmaceutical Products*. *REVISTA DE CHIMIE*, 69(2), p. 297-9.
15. **Roman L., Bojita M., Sandulescu R., 1998** - *Validarea metodelor de analiza si control*, Edit. Medicala, Bucuresti, p. 75-128,
17. **\*\*\*, 2010** - *Farmacopeea Română*, X, Edit. Medicala, Bucuresti, 1993, p. 977-1293.

## AUTOMATIC GRAPHICAL SIMULATION OF HOW TO DETERMINE THE TRUE LENGTH OF A LINE SEGMENT BY CHANGING A PROJECTION PLAN

### SIMULAREA GRAFICĂ AUTOMATĂ A MODULUI DE DETERMINARE A ADEVĂRATEI MĂRIMI A UNUI SEGMENT DE DREAPTĂ UTILIZÂND SCHIMBAREA UNUI PLAN DE PROIECȚIE

PRUNĂ L.<sup>1\*</sup>, SLONOVSKI A.<sup>1</sup>

\*Corresponding author e-mail: lpruna2004@yahoo.com

**Abstract.** *In Descriptive Geometry, it is noticed that when it comes about to the Methods of the Descriptive Geometry, the first theme that raises problems to the students is understanding how to determine the true length of a line segment using the methods of replacing the projection planes. Starting from the problems raised by the students, the authors have created a three-dimensional graphic model to help them understand how to determine the true length of a straight segment using the vertical projection plan change method.*

**Key words:** descriptive geometry, plan projection, graphic model, straight segment, AutoCAD

**Rezumat.** *În activitățile de prezentare a disciplinei Geometrie Descriptivă se observă că în momentul în care se ajunge la capitolul Metodele Geometriei Descriptive prima temă care ridică studenților probleme de înțelegere este cea de determinare a adevăratei mărimi a unui segment de dreaptă utilizând metodele schimbării unui plan de proiecție. Pornind de la problemele semnalate de studenți, autorii au creat un model grafic tridimensional care să-i ajute pe aceștia să înțeleagă modul de determinare a adevăratei mărimi a unui segment de dreaptă utilizând metoda schimbării planului vertical de proiecție.*

**Cuvinte cheie:** geometrie descriptivă, plan proiectant, model grafic, segment de dreaptă, AutoCAD

## INTRODUCTION

The mode of determination, classically on graphical way, of the true length of line segment using the method of replacing the projection planes is made usually using the replacement of the vertical plane [V] or horizontal plane [H] (Prună *et al.*, 2002 ; Slonovski *et al.*, 2006). From the activity with the students it was observed that in both situations the majority of them do not understand the way in that the vertical and horizontal planes are rotating, why is necessary to rotate the planes, why the OX axis rotates and how the true length of the line segment is determined.

To help the students, for that these one to understand the mode of determine of the true length of a line segment, using the replacing of the vertical

---

<sup>1</sup>"Gheorghe Asachi" Technical University of Iași, Romania

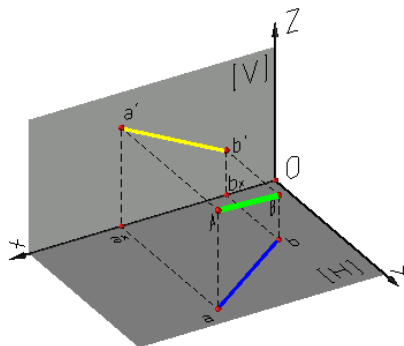
projection plane, the authors proposed the realization of some graphical tridimensional representations, computer assisted, under the AutoCAD software, to clarify the issues reported by students.

## MATERIAL AND METHOD

The issues that have arisen from the beginning concerning to the graphical tridimensional model were:

- finding the optimal alternative so that the graphical simulation shows the rotation of the vertical projection plane [V];
- choosing of an advantageous initial position for the line segment.

Thus, was chosen a position, for the line segment, such that in relation with the horizontal [H] and vertical [V] projection planes, this to be identified with a general position line (fig. 1).



**Fig. 1** The line segment AB has the position of a general position line

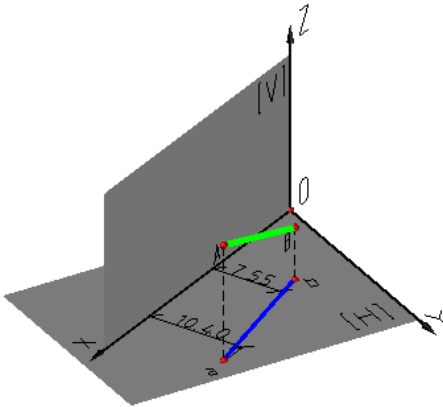
Because must be simulated the replacing of the vertical projection plane [V] it was rotated around the OZ axis of the projection system presented in figure 1, in order that the vertical plane [V] to become parallel with the line segment AB, because in that moment:

- the vertical projection  $a'b'$  will be parallel with the line segment AB and, in this moment, it will be the real length of the line segment AB;
- the horizontal projection  $ab$  of the line segment AB will be parallel with the projection axis OX.

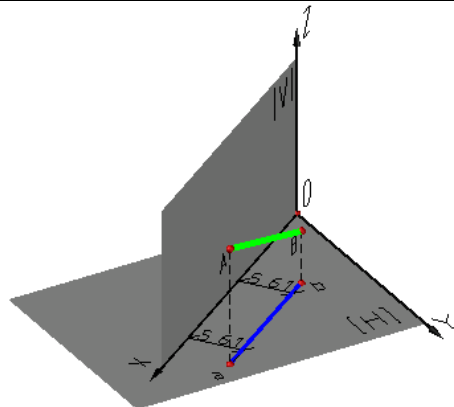
After the vertical projection plane rotation [V] it can be noted:

- the angle between the projection axes OX and OY, angle which must always has  $90^\circ$ , it progressively changes its value, the obtained values being different than  $90^\circ$  (fig. 2, fig. 3);

- at the end of the rotation, the OX axis becomes parallel with the horizontal projection  $ab$  of the line segment AB (fig. 3), thing which had to be achieved.



**Fig. 2** Intermediate position of the vertical plane [V]

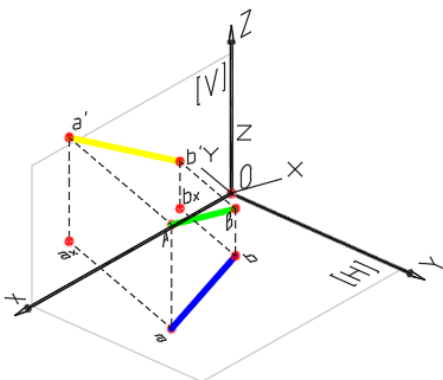


**Fig. 3** The final position of the vertical plane [V]

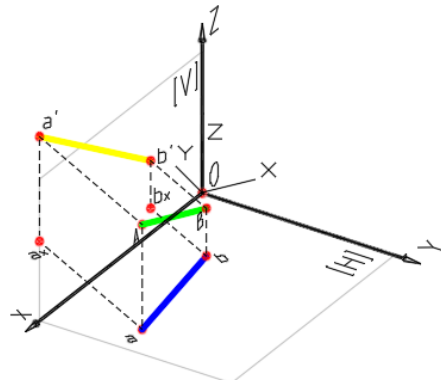
Considering the above, in order to keep the angle of  $90^\circ$  made by the OX and OY axes in the time of simulation of the vertical projection plane rotation [V], for determining of the real length of the line segment AB, the OY axis must be rotated with the same angle used at the rotation of the vertical projection plane [V].

Thus, if the Y axis and the vertical projection plane [V] rotate progressively (fig. 4, fig. 5) it may be noted, because the OX axis changes her position:

- the UCS axes must be rotated for determination the new positions of the  $a_x$  and  $b_x$  points;
- must be repositioned the  $a_x$ ,  $b_x$  points, which are situate on the OX axis;
- must be repositioned the vertical projections  $a'$  and  $b'$  of the A and B points, projections which determine the new vertical projection  $a'b'$  of the line segment AB.

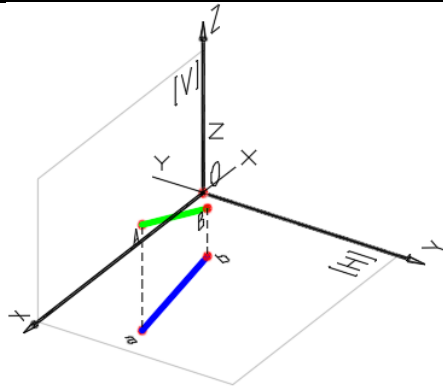


**Fig. 4** Intermediate positions of the AB line segment which highlight the fact that the UCS axes must be rotated and the points  $a_x$ ,  $b_x$ ,  $a'$  and  $b'$  repositioned



**Fig. 5** Intermediate positions of the AB line segment which highlight the fact that the UCS axes must be rotated and the points  $a_x$ ,  $b_x$ ,  $a'$  and  $b'$  repositioned

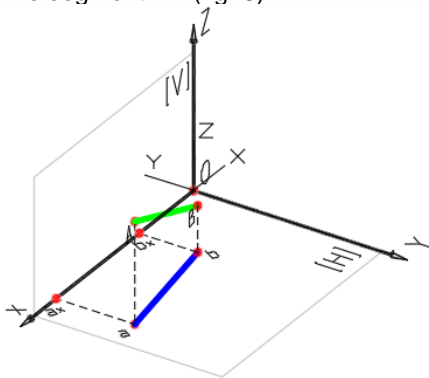
The UCS axes rotation is done so that the X, Y and Z axes are aligned with the X, Y and Z axes of the orthogonal system XYZ (fig. 6).



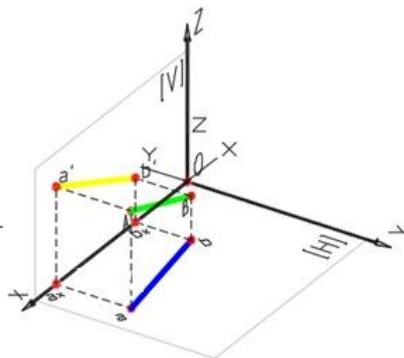
**Fig. 6** The mode in that the UCS axes must be rotated

For the determination of the  $a_x$  and  $b_x$  points which are situated on the OX axis, are drawn, from the a and b perpendicular line to the OX axis (fig. 7).

For the determination of the vertical projections  $a'$  and  $b'$  of the A and B points is drawn from  $a_x$  and  $b_x$  two lines of recall which have the lengths  $Aa$  respectively  $Bb$ . Representing a line segment from  $a'$  to  $b'$  is obtained the vertical projection  $a'b'$  of the line segment AB (fig. 8).



**Fig. 7** The way in that the  $a_x$  and  $b_x$  are determined



**Fig. 8** The way in that the  $a'$  and  $b'$  points are determined

Each of the steps listed above are repeating for each stage which permits bringing, using the replacing vertical plane [V] method, the AB line segment presented in figure 1 from a general position line to a front line.

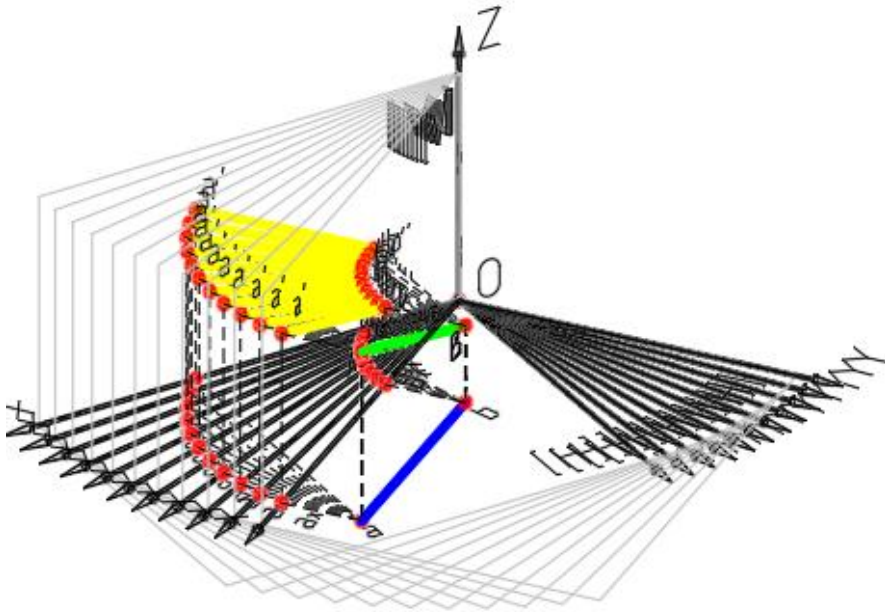
For a clearer view were built in this situation ten transformation representations (steps) of the AB line segment position from a general position line to a front line.

## RESULTS AND DISCUSSIONS

For students to view in a single representation each position of the  $a_x$ ,  $b_x$ ,  $a'$  and  $b'$  points and of the vertical projection  $a'b'$ , the overlap of these ten steps is presented in figure 9.

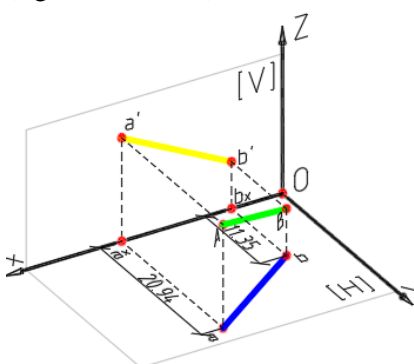
It can be noticed from this figure that this visualization mode is not advantageous because it cannot be clearly observed:

- each position of the plane [V], of the  $a_x$ ,  $b_x$ ,  $a'$ ,  $b'$  points and of the vertical projection  $a'b'$ ;
- the new positions of the recall lines which determines the points listed above;
- keeping of the  $90^\circ$  angle between OX and OY axes.

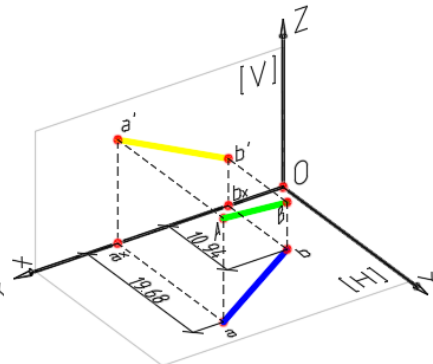


**Fig. 9** The overlapping of all positions

From this reason was proposed the presenting of these ten steps as slides (figures 10 ... 20).



**Fig. 10** Initial position



**Fig. 11** Intermediary position 1

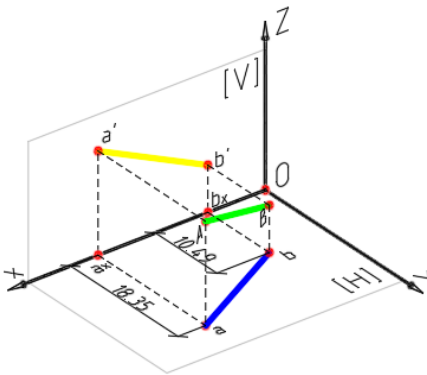


Fig. 12 Intermediary position 2

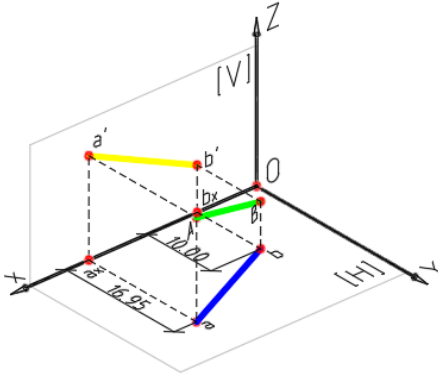


Fig. 13 Intermediary position 3

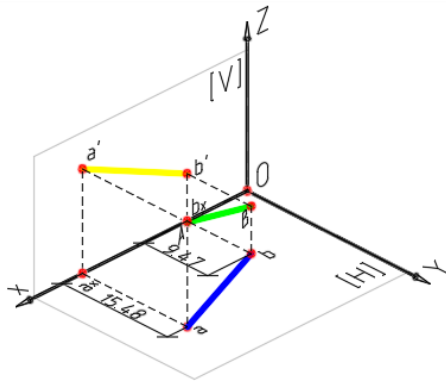


Fig. 14 Intermediary position 4

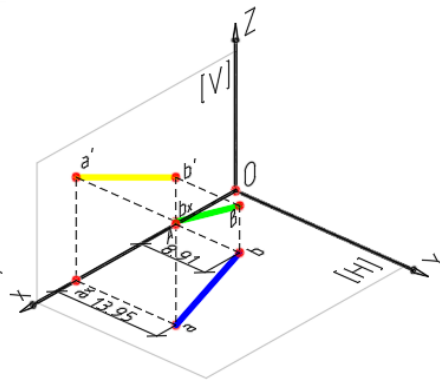


Fig. 15 Intermediary position 5

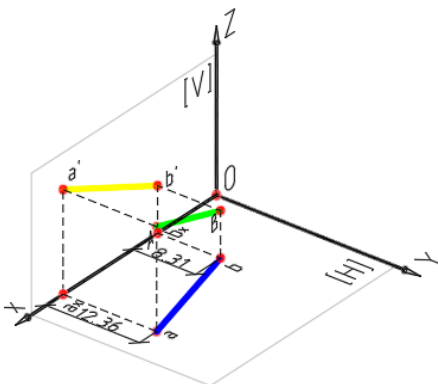


Fig. 16 Intermediary position 6

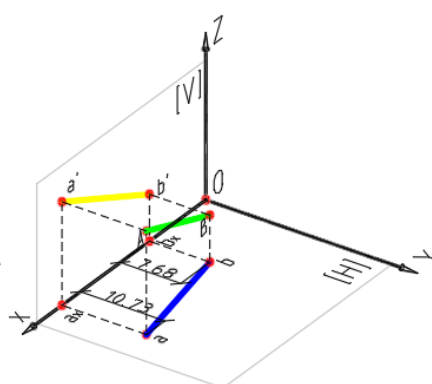


Fig. 17 Intermediary position 7

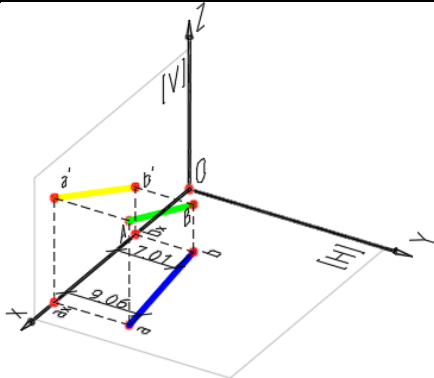


Fig. 18 Intermediary position 8

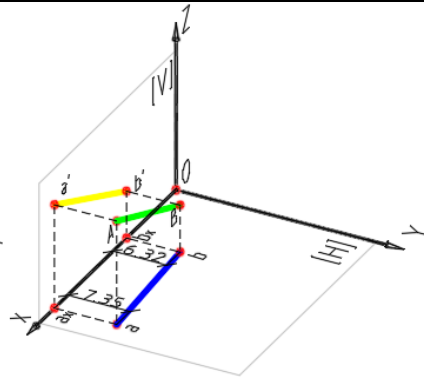


Fig. 19 Intermediary position 9

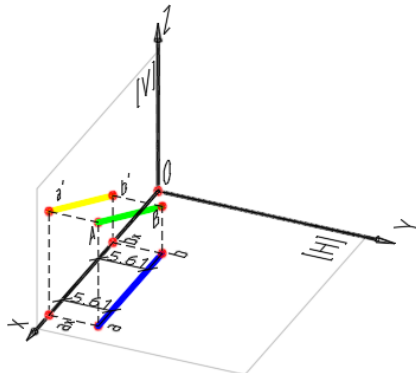


Fig. 20 Intermediary position 10 (the final position)

It can be observed from these images:

- the rotation mode of the OY axis and of the vertical projection plane [V];
- the rotation mode of the XYZ orthogonal system axes;
- the new positions of the  $a_x$ ,  $b_x$ ,  $a'$  and  $b'$  points.
- the new positions of the recall lines which determines the points listed above;
- how the distances  $aa_x$  and  $bb_x$  change until these become equal and the AB line segment occupy the position of a front line;
- the length of the  $a'b'$  line segment is identical with the length of the AB line segment (fig. 20).

The optimal alternative for step by step visualization of those ten imagines is by joining of them in a pdf file which permits rolling forward and back of the slides.

It is known that each stage which permits the vertical projection plane [V] rotation contained the next steps:

- the rotation of the plane [V] and the OY axis;



- the UCS alignment with the new XYZ axes positions;
- the determining of the  $a_x$ ,  $b_x$ ,  $a'$ ,  $b'$  points;
- the union of the  $a'$  and  $b'$  points.

Thus, can be noticed the fact that for the simulation of those ten stages, the number of steps made by the authors was forty.

Result from above that if the number of stages would be higher, for each additional stage the number of steps increase with four.

Starting from these statements the authors thought that if could automatically generate the imagines presented in figures 10 ... 20 with the help of a computer program which may run on the AutoCAD software interface, for example the AutoLISP programming language, the user could do one of the following:

- sets the number of steps desired for a finer or coarse simulation of the rotation of the vertical projection plane [V] and of the OY axis;
- could changes the descriptive coordinates of the A and B points, thing which could lead to numerous variants of theoretical problems automatically solved by the software.

From the first attempts to building of the software it was observed that the multitude of operations which referring to the drawing of the objects which must be represented and the complexity of the steps which must be followed, make the process of writing of the computer program to be complex.

The process of generating of the imagines by the authors is much easier than the process of developing the needed algorithm to build the software.

## CONCLUSIONS

The proposed method by the authors regarding to the graphical visualization of the mode to establishing of the true length of a line segment using the method of replacing of the vertical projection plane [V] which consists in the rotation of the vertical projection plane [V] and of the OY axis, the UCS rotation according to the X, Y, Z axes directions of the orthogonal system XYZ, redesigned for each step of the plane [V] rotation of the  $a_x$ ,  $b_x$ ,  $a'$  and  $b'$  points and the  $a'b'$  vertical projection of the AB line segment, highlights for each stages, the mode of transforming of a line segment, from a general position line to a front line and the determining of the true length of a line segment.

This method can be adapted and for graphical visualization of the determine mode of the true length of a line segment using the method of replacing of the horizontal projection plane [H].

## REFERENCES

1. Prună L., Slonovschi A., Antonescu I., Popescu F., 2002–*Geometrie descriptivă*, Editura tehnică, științifică și didactică Cermi, Iași, p. 67-72.
2. Slonovschi., A., Prună L., Antonescu I., 2006–*Geometrie descriptive. Aplicații*. Editura Tehnopress, p. 203-211.

## RUBUS SPECIES PRESENT IN ALEXANDRU BELDIE HERBARIUM

### SPECIILE DIN GENUL *RUBUS* PREZENTE ÎN HERBARUL *ALEXANDRU BELDIE*

*DINĂ L.*<sup>1\*</sup>, *VASILE Diana*<sup>1</sup>, *DINĂ Maria*<sup>1</sup>, *BLAGA Tatiana*<sup>2</sup>

\*Corresponding author e-mail: dinka.lucian@gmail.com

**Abstract.** *Rubus* Genus, which encompasses 750 species spread out on almost all continents, has a significant importance, both from a botanical perspective, as well as an economical and medicinal one. The purpose of the present paper is to describe some of the most important species belonging to the *Rubus* Genus present in the Al. Beldie Herbarium from INCDS „Marin Drăcea”, Bucharest. As such, the paper analyzes the species harvesting year and place, the botanists that have collected them as well as the plates conservation state. As a total, 114 plates that belong to the *Rubus* Genus were analyzed, namely 65 species. The species with most samples present in the herbarium is *Rubus caesius* L., followed by *R. idaeus* L. and *R. tomentosus* Borkh. The *Rubus* species were collected from France, Poland, Germany, Austria and Romania (Bucegi Mountains, Brașov, Arad, Timișoara, Caransebeș, Vâlcea, Buzău, Ilfov, Maramureș). The *Rubus* samples present in the herbarium were collected between 1853 and 1999, the majority of them being gathered between 1887 and 1942 by renowned local or foreign botanists. The conservation state of the plates is generally good.

**Key words:** herbarium, *Rubus*, blackberry, raspberry, plants

**Rezumat.** Genul *Rubus*, care cuprinde 750 de specii răspândite pe aproape toate continentele, are o importanță deosebită, atât din punct de vedere botanic, cât și economic sau medicinal. Scopul acestui articol este de a descrie câteva specii mai importante din genul *Rubus* prezente în colecția Herbarului Al. Beldie, de a analiza anul recoltării acestor specii, locul de unde s-au prelevat, botaniștii care au realizat acest lucru și starea de conservare a planșelor. Au fost analizate 114 planșe care aparțin genului *Rubus*, aparținând la 65 de specii ale acestui gen. Specia cu cele mai multe exemplare în herbar este *Rubus caesius* L., urmată de *R. idaeus* L. Speciile de *Rubus* au fost colectate din Franța, Polonia, Germania, Austria, România. Exemplarele de *Rubus* din herbar au fost colectate între anii 1853 și 1999, de către botaniști renumiți din țară sau străinătate. Starea de conservare a planșelor este în general bună.

**Cuvinte cheie:** herbar, *Rubus*, zmeur, mur, plante

## INTRODUCTION

*Rosaceae* Family is formed of approximately 90 genres and 2520 species and can be found predominantly in the temperate regions of the north hemisphere

<sup>1</sup> “Marin Drăcea” National Institute for Research and Development in Forestry, Brașov, Romania

<sup>2</sup> “Marin Drăcea” National Institute for Research and Development in Forestry, Bacău, Romania

(Seeram, 2008; Khatamsaz, 1992). *Rubus* Genus (*Rosaceae*, *Rosoideae* subfamily) includes perennial herbaceous shrubs or plants.

The general assumption is that the species originates in South-West China (Gu *et al.*, 1993), as this area is archaic from a geological point of view and was not covered by glaciers during the Quaternal period.

At least 299 botanic taxons are described as originating from China, being distributed in 27 provinces (Gu *et al.*, 1993). Vavilov (1940) considers that China occupies “the first place in the entire world” in regard with “the composition of wild and cultivated fruits.”

*Rubus* Genus encompasses 750 species (Robertson, 1974; Lu, 1983; Gu *et al.*, 1993; Thompson, 1995) and can be found on all continents with the exception of Antarctica (Focke, 1910, 1911, 1914; Gustafsson 1942, 1943; Spies and Du Plessis, 1985; Hummer, 1996).

Most *Rubus* species are perennial shrubs with biannual stems. The plant's position varies from erect to crawling. Some plants are runner (*R. cissoides* Cunn. From New Zealand), while others are small alpine forms that spread through subterranean stool (*R. chamaemorus* L.).

Most species have falling leaves, but there are also some species that are always green. The leaves differ in length from 1 cm up to 20 cm. Also, the leaves can be whole, lobate, trifoliolate, pent foliated or pennate composed. The stem's diameter varies from 2 to 7 cm. Furthermore, *Rubus* species can have large spines on the stem that can reach 1.5 cm in length, trichomes or neither spines nor trichomes (Smolarz and Zmarlicki, 1993).

Ripe fruits have colors that vary from white to yellow, orange, red, purple or black. The fruit is apocarpic, multiple and pulpy (poly drupe). The weight varies on the species, from 0.4 g (Gu *et al.*, 1993) to 20.5 g (Hall, 1990).

*Rubus* species are extremely important, both from an economical point of view (for the fruits), as well as from a medicinal one (leaves and fruits).

The purpose of the present paper is to describe some of the most important *Rubus* species present in the Al. Beldie Herbarium from INCDS „Marin Drăcea” Bucharest.

## MATERIAL AND METHOD

The plant collections from Al. Beldie Herbarium were used as a main material in order to describe the *Rubus* species. The Herbarium was created in 2002 within INCDS Bucharest (Vasile *et al.*, 2016), being besides the library and laboratories an essential part of the research institute.

The collection holds over 40.000 plates with wood and herbaceous forest species, moss, lichen, fern and plants from the Red list (Cântar *et al.*, 2017; Crișan *et al.*, 2017; Dincă *et al.* 2017; Dincă *et al.*, 2018; Dincă *et al.*, 2017; Enescu *et al.*, 2018; Scărlătescu *et al.* 2017). As such, the herbarium contains plants from all continents originating from private donated collections or foreign collections obtained from exchanges. 10.000 plates have belonged to academician Al. Beldie, who has gathered them himself.

## RESULTS AND DISCUSSIONS

The enterprised investigations have identified the presence of 114 plates in the Herbarium that belong to the *Rubus* Genus. Within these plates, 65 species belonging to this Genus were identified.

The species with most samples present in the herbarium is *Rubus caesius* L., representing 22% of the total 65 species, followed by *R. idaeus* L. and *R. tomentosus* Borckh.- 9%, *R. parviflorus* Nutt. and *R. saxatilis* L. – 6%, *R. bifrons* Vest., *R. candicans* Weiche ex Rcb, *R. arcticus* L., *R. dumetorum* Schldtl., *R. hirtus* L., *R. maximus* Marsson and *R. odoratus* L. – 5%. The other species are present in the herbarium only with one sample.

The *Rubus* species were gathered from France, Poland, Germany, Austria and Romania (namely Bucegi Mountains, Brașov, Arad, Timișoara, Caransebeș, Vâlcea, Buzău, Ilfov, Maramureș) (fig.1).

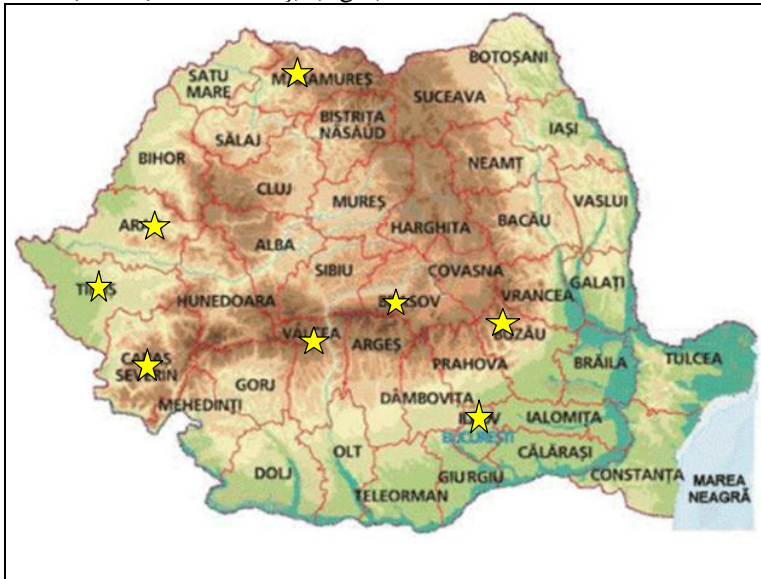


Fig. 1 *Rubus* samples present in the Herbarium and collected from Romania

***Rubus caesius* L. – Plain blackberry.** Native species spread out in all Europe, Caucasus, Central Asia and West Siberia. The plant appears both in the forest fund as well as outside it, especially in plains (Stănescu *et al.*, 1997).

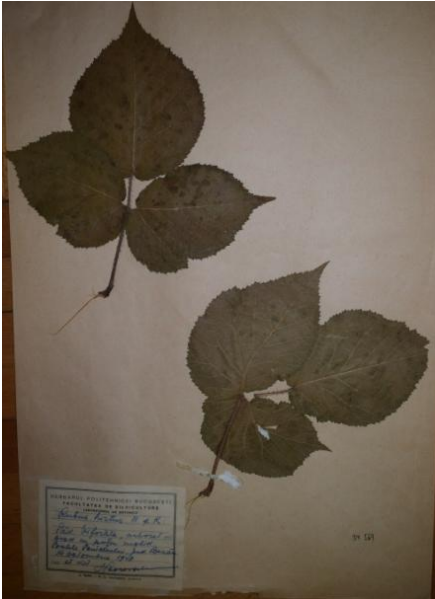
The plant has a small stature, subarbutive, ranging from 0.2 up to 1m, that can be found at a very low altitude. The stems are pale green, slender, rounded (not polygonal) and with glandular trichomes. The species blooms from June until September, while the fruits appear from July until September. The sepals are large, almost erect on the fruits, while the petals are white. The fruits are poly drupes, black-blue-brown in color (Hummer, 1996; Joshua *et al.*, 2013).

The plant can grow on very alkaline soils in semi-shadow or without shadow, preferring however humid soils (Wyremblewska *et al.*, 2010).

***Rubus hirtus* W et K – crawling blackberry** (fig. 2). Native shrub with crawling stems that are short and spiky, forming dense carpets that restrain the regeneration of forests; the stem presents spikes and red or dark blue unequal, pedicellate glands (Hummer, 1996).

The leaves alternate and have 3 variable folioles, unequally serrated and hairy on the back; the terminal foliola is larger. The leaves are green also during winter and become red due to the cold (hibernated leaves). The plant blooms from June until September. The fruits are black poly drupes, sweet and eatable (Joshua *et al.*, 2013).

Forest blackberry is common all-around Europe and present in Romania from hills (holm stands, common beech stands), up to the mountain floor. It is a relatively hygrophyte species, pretentious towards atmospheric humidity. Although it is resistant in shadow, it does not produce fruits in this condition. The plant is important from an economic point of view, having numerous benefits (Lee *et al.*, 2012).



**Fig.2** *R. hirtus* collected in 1949



**Fig.3** *R. idaeus* collected by Wolff in Cluj

***Rubus idaeus* L. – Raspberry** (fig. 3). It is a native species that grows in areas with temperate and cold climate from Europe and Asia. Furthermore, the plant is frequently found in our country starting from hill regions un to high altitudes. It appears especially in exploited areas (felling areas) as well as in open woods and forest clearings (Stănescu *et al.*, 1997).

The plant forms shrubs with numerous stems erect, that can reach 1-2.5 m in height. The sprouts are geniculated, green-gray in color and with spikes

situated especially towards the base of stems. The leaves are imparipinnate composed, with 5-7 folioles, glabrous and green on the superior side, while white-tomentose on the inferior one. The flowers are white, small and appear in May-June (Williams, 1959). The fruit is a globular poly drupe, red when it reaches maturity, succulent, sweet and easily detachable from the receptacle. The fructification is abundant in full light (Dale, 2008).

***Rubus parviflorus* Nutt. – thimble raspberry** (fig. 4). A native species from North America that grows from the sea level in North up to altitudes of 3000 m in South. It usually develops alongside roads and railroads and appears as an ecological succession in forests with thinning or with forest fires (Griffith and Ganders, 1993).

***Rubus parviflorus*** is a dense shrub that can reach up to 2.5 meters in height and with stems without spikes that can reach a diameter of 1.5 centimeters.

The leaves are palmate, up to 20 centimeters (much larger than all *Rubus* species), with five lobes and a soft, hairy texture. The flowers are among the largest of any *Rubus* species, being in contrast with the plant's Latin name *parviflorus* ("small flower"). The plant produces red eatable fruits of approximately one centimeter in diameter, that appear from June until the end of August. The harvested fruit resembles a thimble and gives the plant its thimble raspberry name (USDA 2015).

***Rubus saxatilis* L. – cliff raspberry** (fig. 5). It is a species largely spread out in Europe and Asia, from Iceland and East Spain to China. The stems are green and reach a height of 20-60 cm, being covered by short spikes as a needle. The leaves are usually composed of three folioles. The inflorescence is a corymb, with a few flowers.



Fig. 4 *R. parviflorus* collected by Ș. Pașcovschi



Fig. 5 *R. saxatilis* collected by Al. Beldie in 1942 in Caraiman

The fruit is an aggregate of many red, pulpy drupes, spherical and red, with a diameter of 1-1.5 cm and it contains large kernels (Hummer 1996; Richards *et al.*, 1996).

Cliff raspberry appears on rocky fields, in humid forests and in exploitation feeling areas after the trees have been cut (Wyremblewska *et al.*, 2010).

***Rubus tomentosus* Borkh.** *Rubus tomentosus* Borkhausen var. *canescens* (de Candolle) Wirtgen, is a European species similar with *R. bifrons* and *R. vestitus*, but more pubescent than each of them.

It usually grows in South and Central Europe and South-West Asia, from Portugal up to Iran, North Germany, Poland and Ukraine (Kosiński and Bednorz, 2003).

The leaves are small, with 3 or 5 folioles, elliptically elongated, white-tomentose on the inferior side, green on the superior side and dented on the margins. The flowers are small, yellow and in panicle (Oklejewicz, 2006).

***Rubus candicans* Weiche ex Rcb.** A tall shrub with long stems, covered by numerous spikes. The leaf is pinnate composed and formed of 5 folioles. The stems are vertical at the beginning and as they grow they start to bend and lose their spikes. The fruits are round, being formed of more small and pulpy drupes (Domac, 1984).

***Rubus arcticus* L.** It is spread out in Alaska, North Scandinavia, Russia, Mongolia, Belarus, Poland, North-East China, North Korea, Estonia, Lithuania, Canada and North America.

The plant develops well on acid soils rich in organic matter. It is a spike shrub that can grow up to 30 cm in height, woody at the base, but very slender above the soil. The fruits are sharp red or dark purple and have an unusual resistance towards frosts and cold meteorological conditions. The fruits are extremely tasteful, being considered a delicacy and called “the prince raspberry” in Russia (Karp *et al.*, 1997).

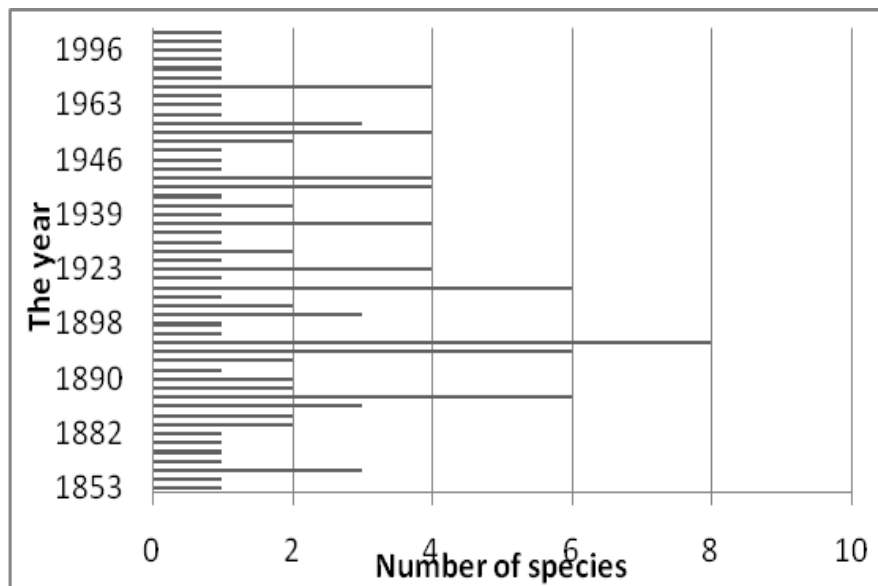
***Rubus dumetorum* Schldl (*R. schiedeanus*).** Is a shrub that grows in South Mexico and Central America, being a perennial, pubescent and spiky plant. The leaves are composed of 3-5 thick folioles, while the flowers have white petals and the fruits are black drupes (García-Mendoza and Meave, 2011).

***Rubus maximus* Marsson.** It is a shrub spread out in South and West Baltic coast, including Usedom, Rügen and Hiddensee islands (Henker and Kiesewetter, 2009).

The stems are erect or sub-erect, 1-1.5 m in height, glabrous, green and sometimes purple in the part exposed toward the sun. The plant presents dark purple spikes, straight or slightly sloping, reaching 2-4 mm in length. The leaves have 4-5 large folioles that can reach 35,5cm in length (Henker and Kiesewetter, 2009). Fruits appear during July-August, are black-red drupes and many are not fully developed (Kosinski and Zielinski, 2013).

***Rubus odoratus* L.** A native shrub from East North America that prefers partially shaded areas with rich soils, slightly acid and with a moderate water content. The stems can reach 3 meters in heights. The leaves are palmate lobate, with 5 lobes (rarely 3 or 7), 25 centimeters in length. The flowers have 3-5 cm in diameter, 5 magenta or very rarely white petals that bloom in early spring up to late autumn. The fruits are eatable, red and appear towards the end of summer and the beginning of autumn (Robertson, 1974). The species was introduced in Europe (South-East UK) where it was naturalized.

The *Rubus* samples from the herbarium were collected between 1853 and 1999, while most of them were gathered between 1887 and 1942 (fig. 6).



**Fig. 6** The period in which the herbarium samples were collected

Collecting and classifying *Rubus* samples was realized by Romanian (Al. Beldie, I. Morariu, G.P. Grințescu, C.C. Georgescu, S. Pașcovschi, Șt. Purcelean) and foreign botanists (C. Baenitz, A. Goety, A. Goetz, K Richter, F. Schultz, C. Beckmann and E. Krummel).

The samples conservation state is generally good, most plants being only detached from the plates, with released but existent parts (second degree) or detached and lacking parts (third degree) (fig. 7). There are however numerous plates with well conserved plants, in its entirety and correctly attached to the plate (first degree) and only three plates with detached and fragmented plants, lacking more than 50% of its components (fourth degree).



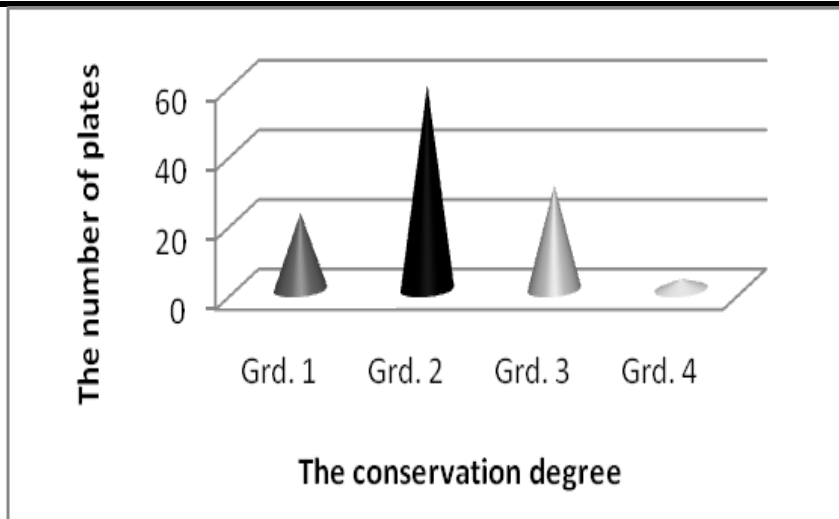


Fig. 7 The conservation degree of the herbarium samples

## CONCLUSIONS

The plates with the 65 *Rubus* species present in the herbarium are remarkable through their good conservation state and their peculiar scientific value as all have kept their original labels. Even though most of them are over 160 years old, they were identified and collected by Romanian and international botanists.

Through the inventory of *Rubus* species it can be observed that Al. Beldie Herbarium contains a vast depository of valuable information about *Rubus* species from the entire Europe, as well as about biodiversity in general. Furthermore, the Herbarium is a valuable source of information concerning these species, their characteristics and their spreading areal.

## REFERENCES

1. Cântar I.C., Dincă M., 2017 - Two genus of plants from Poaceae family (*Melica* and *Eragrostis*) existing in "Alexandru Beldie" herbarium of I.N.C.D.S. Bucharest. JOURNAL of Horticulture, Forestry and Biotechnology, Volume 21(3), 2017, pag. 68-76.
2. Crișan V., Dincă L., Oneț C., Oneț A., 2017 - Collection species from *Potentilla* genus. Natural Resources and Sustainable Development, pag. 27-34.
3. Dale A. 2008 - Raspberry production in greenhouses: physiological aspects. Acta Hort. 777, 219–223.
4. Dincă L., Vasile D., Dincă M., 2017 - Short characterisation of plant species from *Centaurea* genus present in Al. Beldie Herbarium from Marin Dracea National Institute for Research and Development in Forestry Bucharest, Annals of University of Craiova - Agriculture, Montanology, cadastre Series, Vol. 47, pp 127-135.

5. Dincă L., Dincă M., Pantea S.D., Timiș-Gânsac V., Oneț C., 2018 - *Amaranthus plant - between myth and usage*. Natural Resources and Sustainable Development, Vol. 8, No. 1, pag. 9-16.
6. Dincă M., Dincă L., Vasile D., 2017 - *A short description of Androsace genre plants present in Alexandru Beldie Herbarium from I.N.C.D.S. Bucharest*. Current Trends in Natural Sciences, Vol. 6, Issue 12, pag. 16-24.
7. Domac R. 1984 - *Mala flora Hrvatske i susjednih područja*. Školska knjiga, Zagreb.
8. Enescu C.M., Dincă L., Cântar I., 2018 - *First of "Alexandru Beldie" Herbarium*. Research Journal of Agricultural Science, Vol 50, No.1, p. 57-61.
9. Focke W.O. 1910 - *Species Ruborum monographiae generis Rubi prodromus*. Bibliotheca Botanica 17: 1–120.
10. Focke W.O. 1911 - *Species Ruborum monographiae generis Rubi prodromus*. Bibliotheca Botanica 17: 121–223.
11. Focke W.O. 1914 - *Species Ruborum monographiae generis Rubi prodromus*. Bibliotheca Botanica 17: 1–274.
12. García-Mendoza A.J. and Meave J.A. 2011 - *Diversidad Florística de Oaxaca: de Musgos a Angiospermas 1–351*. Universidad Nacional Autónoma de México, Ciudad Universitaria.
13. Griffiths A.J.F. and Ganders F.R., 1983 - *Wildflower Genetics-a Field Guide for British Columbia and the Pacific Northwest*. Flight Press, Vancouver.
14. Gu Y., Zhao C.M., Jin W., Li W.L., 1993 - *Evaluation of Rubus germplasm resources in China*. Acta Hort. 352:317–324.
15. Gustafsson A. 1942 - *The origin and properties of the European blackberry flora*. Hereditas 28: 249–277.
16. Gustafsson A. 1943 - *The genesis of the European blackberry flora*. Lunds Universitets Årsskrift 39: 1–200.
17. Hall H. 1990 - *Blackberry breeding*, p. 249–312. In: J. Janick (ed.). Plant breeding reviews. vol. 8. Timber Press, Portland, Ore.
18. Henker H. and Kiesewetter H., 2009 - *Rubus-Flora von Mecklenburg-Vorpommern (Brombeeren, Kratzbee-re, Himbeeren, Steinberre)*. Botanischer Rundbrief für Mecklenburg-Vorpommern 44.
19. Hummer K.E. 1996 - *Rubus diversity*. Horticulture Science 31, 182-183.
20. Joshua S., Caplan J., Yeakley A., 2013 - *Functional morphology underlies performance differences among invasive and non-invasive ruderal Rubus species*. Oecologia.
21. Karp K., Staras M., Värnik R., 1997 - *The arctic bramble (Rubus arcticus L.) – the most profitable wild berry in Estonia*. Baltic Forestry 2: 47-52
22. Khatamsaze M. 1992 - *Flora of Iran (Rosaceae)*. Research institute of forests and rangelands 6, 20-35.
23. Kosiński P. and Bednorz L., 2003 - *Trees and scrubs of the Polish part of the Eastern Sudety Mts*. Dendrobiology 49: 31–42.
24. Kosinski, P. and Zielinski J., 2013. - *Rubus maximus (Roaceae) found also in Poland*. Roczniki Akademii Rolniczej w Poznaniu CCCXCI. Botanika - Steciana nr.17.
25. Lee J., Dossett M., Finn C.E., 2012 - *Rubus fruit phenolic research: The good, the bad, and the confusing*. Food chemistry 130, 785-796.
26. Lu L.T. 1983 - *A study on the genus Rubus of China*. Acta Phytotaxonomica Sinica 21: 13–25.
27. Richards, A.J., Kirschner, J., Stepanek, J., Marhold, K., 1996 - *Apomixis and taxonomy: an introduction*. Folia Geobotanica Phytotaxonomica 31: 281–282.
28. Oklejewicz K. 2006 - *Distribution patterns of Rubus species (Rosaceae) in the eastern part of the Polish Carpathians*. Polish Botanical Studies 21: 1–98. ISBN 83-89648-30-X.

29. **Robertson K.R. 1974** - *The genera of Rosaceae in the southeastern United States*. Journal of the Arnold Arboretum 55: 303–662.
30. **Scărlătescu V., Vasile D., Dincă L., 2017** - *Plant species from "Al. Beldie" Herbarium - Orobanche genre - short description*. ProEnvironment Promediu, 31(10), 191 - 198.
31. **Seeram NP. 2008** - *Berry fruits: Compositional elements, biochemical activities, and the impact of their intake on human health, performance, and disease*. Journal of Agricultural and Food Chemistry 56, 627–629.
32. **Smolarz K. and Zmarlicki K., 1993** - Sixth international symposium on Rubus & Ribes. Acta Hort. 352:1–606. Skierniewice, Poland.
33. **Spies J.J. and du Plessis H., 1985** - *The genus Rubus in South Africa, I. Chromosome numbers and geographical distribution of species*. Bothalia 15: 591–596
34. **Stănescu V., Șofletea N., Popescu, O., 1997** - *Flora forestieră lemnoasă a României*. Ed. Ceres, București, pp 446.
35. **Thompson M.M. 1995** - *Chromosome numbers of Rubus species at the National Clonal Germplasm Repository*. HortScience 30: 1447– 1452.
36. **United States Department of Agriculture (USDA). 2015**. *Plants Database*. Natural Resources Conservation Service.
37. **Vasile D., Dincă L., Indreica A., Voiculescu, I., 2016** - *Herbarul Alexandru Beldie - o colecție de plante și o importantă bază de date pentru specialiști*. Revista de Silvicultură și Cinegetică, nr. 39, 114-119.
38. **Vavilov N.I. 1940** - *Uchenie o proiskhozhdenii kul'turnykh rasteniy posle Darvina*. [The theory of the origin of cultivated plants after Darwin]. Sov. Nauka [Soviet Science] 2:55–75.
39. **Williams I.H. 1959** - *Effects of environment on Rubus idaeus L. III. Growth and dormancy of young shoots*. J. Hort. Sci. 34, 210–218.
40. **Wyremblewska A.T., Zielinski Guzicka M., 2010** - *Morphology and anatomy of Blackberry pyrenes (Rubus L., Rosaceae) elementary studies of the European representatives of the genus Rubus L.* Flora 31, 370–375.

## FLORISTIC COMPOSITION AND DIVERSITY INDICES OF WOODY SPECIES IN FĂGET FOREST, CLUJ-NAPOCA, NORTH WESTERN OF ROMANIA

### COMPOZIȚIA FLORISTICĂ ȘI INDICII DE DIVERSITATE A SPECIILOR LEMNOASE DIN PĂDUREA FĂGET, CLUJ-NAPOCA, NORD VESTUL ROMÂNIEI

SESTRAȘ P. <sup>1,3</sup>, CETEAN H. <sup>2</sup>, DAN Cătălina <sup>2\*</sup>, NAS S. <sup>3</sup>,  
SPALEVIC V. <sup>4</sup>, BOSCAIU Monica <sup>5</sup>, CÎMPEANU S.M. <sup>1</sup>

\*Corresponding author e-mail: catalina.dan@usamvcluj.ro

**Abstract.** Periurban forests and urban green spaces provide an extremely useful ecological infrastructure for modern cities. The study of woody species diversity in Făget Forest, located near Cluj-Napoca city, in N-W of Romania, highlighted the consolidated diversity of trees species, but also floristic communities resulted as from the natural evolution and interactions with environmental and anthropic factors. Although the diversity of woody species in Făget Forest calculated by diversity indices appear limited or low (Shannon-Wiener < 1), the communities have been strengthened over time, consequently the conservation status of the habitat type in terms of structure and specific functions appear as stable. The preservation of Făget Forest diversity, as well as its economic, ecological, cultural, landscape, recreational and other forest functions can assure important benefits to the city and its inhabitants.

**Keywords:** floristic communities, forest, periurban spaces, diversity indices

**Rezumat.** Pădurile periurbane și spațiile verzi din mediul urban oferă o infrastructură ecologică extrem de utilă pentru orașele moderne. Cercetarea diversității speciilor lemnoase forestiere din pădurea Făget, în partea de nord-vest a României, în imediata apropiere a orașului Cluj-Napoca, a permis evidențierea diversității speciilor de arbori, dar și comunitățile de arbori rezultate în urma procesului evolutiv și a interacțiunilor speciilor cu factorii de mediu și antropici. Deși diversitatea speciilor lemnoase din Pădurea Făget, calculată pe baza indicilor de diversitate este limitată sau redusă (Shannon-Wiener < 1), comunitățile formate au fost consolidate de-a lungul timpului, prin urmare statutul de conservare a tipului de habitat în ceea ce privește structura și funcțiile specifice ecosistemelor forestiere este stabil. Conservarea diversității pădurii Făget, precum și menținerea funcțiilor economice, ecologice, culturale, peisagistice, recreative ale pădurii pot asigura beneficii importante orașului și locuitorilor săi.

**Cuvinte cheie:** asociații vegetale, indici de diversitate, păduri, zone periurbane

<sup>1</sup>University of Agronomic Sciences and Veterinary Medicine, Bucharest, Romania

<sup>2</sup>University of Agricultural Sciences and Veterinary Medicine, Cluj-Napoca, Romania

<sup>3</sup>Technical University of Cluj-Napoca, Romania

<sup>4</sup>University of Montenegro, Geography, Nikšić, Montenegro

<sup>5</sup>Universitat Politècnica de València, Spain, Mediterranean Agroforestry Institute, Valencia, Spain

## INTRODUCTION

'Urban Green Infrastructure' is becoming an increasingly desirable goal in delivering essential ecosystem services in cities. Securing ecosystem services by green spaces and trees becomes a necessity with the rise of the world's population and the formation of large urban agglomerations, industrialization, global climate change or global warming and greenhouse effect (Davies and Laforzezza, 2017; Pearlmutter *et al.*, 2017; DeClerck *et al.*, 2010).

Periurban forests and urban green spaces provide an extremely useful ecological infrastructure for modern cities, that help control storm water runoff, pollutant filtration, temperature balancing, etc. In addition to ecological benefits, they assure important landscape, educative and cultural tools, but also outdoor recreation facilities (Blood *et al.*, 2016; Tu *et al.*, 2016; Sestraș *et al.*, 2018).

Făget Forest, belonging to Făget-Chinteni Forest District (U.P. II) is located in the vicinity of Cluj-Napoca city, in the North Western part of Romania. With a general move towards urbanization, Cluj-Napoca faces unprecedented expansion of the city limits and population, thus land is becoming an increasingly difficult resource to manage and preserve, and the local forests are no exception to the constant anthropic interferences of damaging the ecosystem and the stability of the soil. Cluj-Napoca, with a population of over 450,000 inhabitants, has a great morphological and landscape diversity. Făget Forest, one of the most important green areas near the city, can play the role of a peri-urban forest with multiple benefits for the ecosystem in the area (Sestraș *et al.*, 2018).

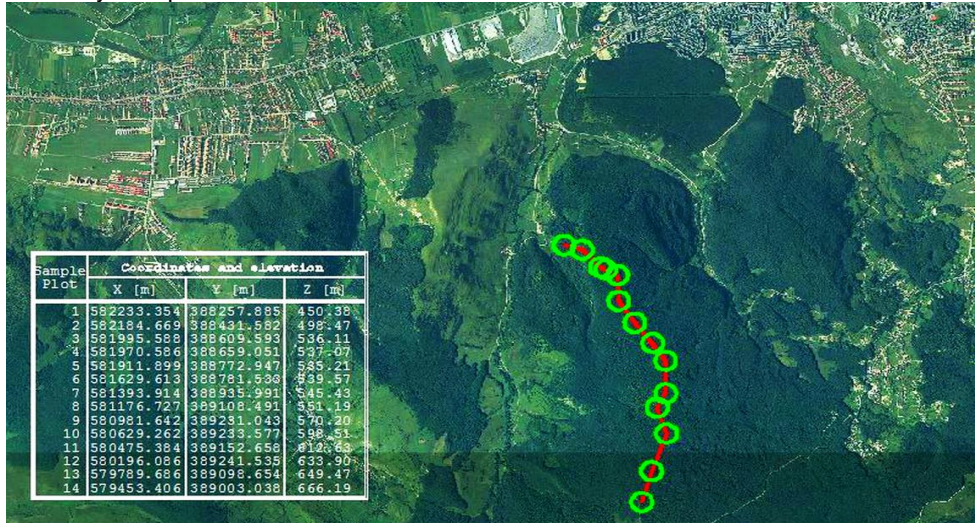
In order to ensure the desired roles and ecosystem services of the forest, it is necessary to know the physical attributes of the forest and the trees, the functional diversity of plant communities, and to study the possibility to maintain or improve the floristic composition of the forest. These factors are indispensable for coping with the complex social, economic and cultural dynamics of the cities in the future.

## MATERIAL AND METHOD

The research area was located in the Făget-Chinteni Forest District (U.P. II Făget-Chinteni), in the forest belongs to the Făget Cluj – Valea Morii site, a part of the Continental Biogeographic Region, which occupies much of Romania's territory, as well as much of Central and Western Europe (Natura 2000 - Proiect POS M: SMIS-CSNR 43241, 2015).

Topographic measurements were conducted by determining coordinates using the GNSS RTK technology (Global Navigation Satellite System - Real-time Kinematic) and a StonexS8 instrument. The coordinates were expressed in the Romanian National Projection System, respectively the Stereographic Projection 1970 and the elevations were reported to the Black Sea level. The accuracy of coordinates determined by RTK method of the Stonex GPS was 20 mm in a horizontal direction

and 30 mm in vertical direction. The real-time kinematic based global positioning system enabled by satellite navigation offers a modern alternative technology to the previous topographic instruments. The topographic measurements were performed in March, when the snow has melted and the trees had no leaves yet, thus a good connection to the satellites was possible and accurate data obtained (fixed position). At each of the 14 sample plots chosen along the forest transect (fig. 1), forest inventory was performed.



**Fig. 1** Transect containing 14 plots along the Făget Forest, in close proximity to Cluj-Napoca

Each of the sample plots (of circular shape, with a radius of 12.62 m, 500 square meters) had a central tree, where the coordinates were measured. In order to carry out the study, quantitative and qualitative characteristics were taken into account, with measurements and observations being made on 413 specimens of trees. The total length of the path through the forest was 3295.33 m and the elevation of the first sample plot and the last was 450.38 m and 666.19 m, thus an elevation difference of 251.81 m. There were considered only natural forest sites, with regular growth of the trees, with no plantation intervention as non-native trees and/or invasive non-native species.

In the current work, according to the proposed objectives, ecologic indices - Constancy (C), Dominance (D) and Index of Ecological Significance (IES, or W) - were computed and interpreted following Cenusa *et al.* (2004), and biodiversity indices have been calculated following the models presented by Kent (2011) and Magurran (2013)

## RESULTS AND DISCUSSIONS

In the 14 plots analyzed there were registered 413 trees, belonging to eight species (fig. 2, tab. 1). Of all the trees present in the researched area, the largest percentage has been identified for the species *Carpinus betulus* (42.9%), followed by *Fagus sylvatica* (24.9%), and *Quercus petraea* (23.2%). The species *Carpinus betulus* and *Quercus petraea* were identified

in 12 (C=85.7%) respectively 11 plots (C=78.6%), appearing as euconstant species (with a percent of constancy comprised between 75.1-100%).

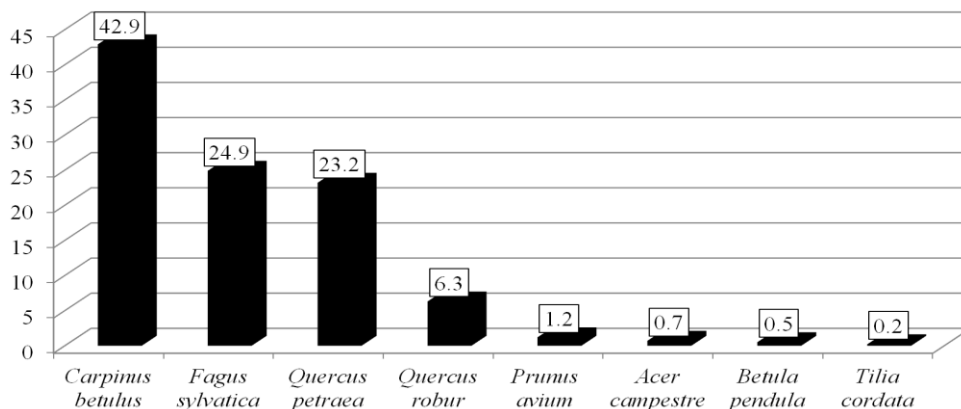


Fig. 2 Percentage of the trees per species, in the 14 plots of Făget Forest

Based on constancy value (C), which reflect the species continuity in the biotope, *Fagus sylvatica* (C=71.4%) and *Quercus robur* (C=57.1%) were assigned to constant species. The rarest presence were registered for the species: *Acer campestre* and *Betula pendula* (2 plots) and *Tilia cordata* (just in one plot from 14), all of them being considered accidental species (C=1-25%).

Table 1  
Constancy (C), Dominance (D) and Index of Ecological Significance (IES, or W) registered for the trees species in 14 plots\*

Species	No of trees	No of plots/sp.	Constancy (C)		Dominance (D)		IES (W)	
			%	Class	%	Class	%	Class
<i>Carpinus betulus</i>	177	12	85.7	C4	42.9	D5	36.7	W5
<i>Fagus sylvatica</i>	103	10	71.4	C3	24.9	D5	17.8	W5
<i>Quercus petraea</i>	96	11	78.6	C4	23.2	D5	18.3	W5
<i>Quercus robur</i>	26	8	57.1	C4	6.3	D2	3.6	W3
<i>Prunus avium</i>	5	4	28.6	C2	1.2	D4	0.3	W2
<i>Acer campestre</i>	3	2	14.3	C1	0.7	D1	0.1	W2
<i>Betula pendula</i>	2	2	14.3	C1	0.5	D1	0.1	W2
<i>Tilia cordata</i>	1	1	7.1	C1	0.2	D1	0.02	W1
Total	413							

\*Note: C1-accidental species (1-25%); C2-accessory species (25.1-50%); C3-constant species (50.1-75%); C4-euconstant species (75.1-100%); D1-subrecedent species (<1.1%); D2-recedent species (1.2-2%); D3-subdominant species (2.1-5%); D4-dominant species (5.1-10%); D5-eudominant species (>10%); W1-subrecedent species (accidental) (<0.1%); W2-recedent species (0.1-1%); W3-subdominant species (accessory) (1.1-5%); W4-dominant species (5.1-10%); W5-eudominant species (characteristic) (>10%).

Concerning the dominance (D), the species *Carpinus betulus*, *Fagus sylvatica*, *Quercus petraea* were grouped as eudominant species (over 10% from the biomass production), which influence decisively the Făget Forest

productivity. *Quercus robur* appeared as dominant ( $D=5.1-10\%$ ), whereas *Acer campestre*, *Betula pendula* and *Tilia cordata* as subprecedent species ( $D<1.1\%$ ).

Based on Index of Ecological Significance (IES, or W), from among the 8 species of trees, the best adapted to the environmental conditions of the area are *Carpinus betulus*, *Fagus sylvatica*, and *Quercus petraea*, all of them being framed in W5-eudominant species (characteristic) ( $>10\%$ ).

The diversity indices presented in table 2 highlighted species richness starting by dividing the species count by the natural log of the number of sampled trees (i.e. Margalef). Even if the number of species was relatively low, variation of the diversity coefficients in the 14 plots was high or very high (CV% between 18.6% for 'Species evenness' and 42.1% for 'Margalef's index' and 'Glisson Coefficient').

Table 2

**Diversity indices as minimum - maximum values, and the average of the 14 plots, and coefficient of variation (CV%) of each index based on its values from 14 plots**

Diversity indices	Min.	Max.	Mean	CV%
Margalef's index (DMg)	0.0	1.2	0.8	42.1
Menhinick's index (DMn)	0.2	1.0	0.7	32.2
Simpson dominance index (D)	0.3	1.0	0.5	32.5
Simpson diversity index (1-D)	0.0	0.7	0.5	37.0
Simpson reciprocal index (1/D)	1.0	3.2	2.0	27.7
Shannon-Wiener diversity index (H')	0.0	1.2	0.8	37.6
Species evenness	0.5	0.9	0.7	18.6
McIntosh index	0.0	0.5	0.3	39.8
Glisson Coefficient	0.0	1.2	0.8	42.1

If these indices simply scaled the number of species to calculate diversity, the Jaccard coefficient (tab. 3) take into account how closely related or similar the species from Făget are.

Table 3

**Similarity in species composition based on the Jaccard coefficient of affinity (%)**

Jaccard's index		Species No.						
		2	3	4	5	6	7	8
1	<i>Carpinusbetulus</i>	20.0	8.3	11.1	20.0	33.3	0.0	0.0
2	<i>Fagus sylvatica</i>		50.0	50.0	16.7	9.1	0.0	10.0
3	<i>Quercus petraea</i>			72.7	25.0	8.3	18.2	9.1
4	<i>Quercus robur</i>				33.3	0.0	11.1	0.0
5	<i>Prunus avium</i>					20.0	20.0	0.0
6	<i>Acer campestre</i>						0.0	0.0
7	<i>Betulapendula</i>							0.0
8	<i>Tilia cordata</i>							

Jaccard similarity coefficient measured a high similarity between *Quercus petraea* and *Q.robur* species (72.7%) and illustrated 50% similarity between *Fagus sylvatica* and the two *Quercus* species. The risk to diversity of this forest is



increasing especially due to the reduction of the habitat surface as a result of the excessive urbanization process of recent years (Natura 2000 - Proiect POS M: SMIS-CSNR 43241, 2015; Sestraș *et al.*, 2018).

## CONCLUSIONS

Although the diversity of wood species in Făget Forest revealed by diversity indices appear limited or low (Shannon-Wiener<1), the communities has been strengthened over time, consequently the conservation status of the habitat type in terms of structure and specific functions appear as stable.

Local authorities must ensure effective measures in order to preserve biodiversity of Făget, but also economic, ecologic, cultural, landscape, recreation facilities and all other functions of the forest.

*Acknowledgments:* The first author (PS) is thankful to the Doctoral School from UASVM Bucharest for the support received in his research during doctoral stage.

## REFERENCES

1. Blood A., Starr G., Escobedo F., Chappelka A., Staudhammer C., 2016 - *How do urban forests compare? Tree diversity in urban and periurban forests of the southeastern US.* Forests, 7(6), 120.
2. Cenușă R., Teodosiu M., Cenușă E., 2004 – *Aspecte privind diversitatea și succesiunea în ecosisteme forestiere marginale (Dealul Radu) din Obcinele Bucovinei.* Bucovina Forestieră, 12(1-2), 31-46.
3. Davies C., Laforteza R., 2017 - *Urban green infrastructure in Europe: Is greenspace planning and policy compliant?* Land Use Policy, 69, 93-101.
4. DeClerck F.A., Chazdon R., Holik.D., Milder J.C., Finegan B., Martinez-Salinas A., Ramos Z., 2010 - *Biodiversity conservation in human-modified landscapes of Mesoamerica: Past, present and future.* Biological Conservation, 143(10), 2301-2313.
5. Kent M., 2011 - *Vegetation description and data analysis: a practical approach.* John Wiley & Sons.
6. Magurran A.E., 2013 - *Measuring biological diversity.* John Wiley & Sons.
7. Pacurar B.N., 2011 – *Funcțiile terțiare ale Municipiului Cluj-Napoca.* Presa Universitara Clujeana 459 p.
8. Pearlmutter D., Calfapietra C, Samson R, O'Brien L, KrajterOstoic S, Sanesi G, Alonso del Amo R (eds.), 2017 - *The Urban Forest. Cultivating Green Infrastructure for People and the Environment.* Volume 7, Springer AG, 351 p.
9. Sestraș P., Bondrea M., Cetean H., Sălăgean T., Bilașco Ș., Nas S., Spalevic V., Fountas S., Cîmpeanu S.M., 2018 - *Ameliorative, Ecological and Landscape Roles of Făget Forest, Cluj-Napoca, Romania, and Possibilities of Avoiding Risks Based on GIS Landslide Susceptibility Map.* Notulae Botanicae Horti Agrobotanici Cluj-Napoca, 46(1), 292-300.
10. Tu G., Abildtrup J., Garcia S., 2016 - *Preferences for urban green spaces and peri-urban forests: An analysis of stated residential choices.* Landscape and Urban Planning, 148, 120-131.
11. \*\*\*, Natura 2000 - Proiect POS M: SMIS-CSNR 43241, 2015 – *Elaborarea planurilor de management integrat pentru siturile de importante comunitara ROSCI0074, Fagetul Clujului - Valea Morii s.a. ID Proiect POS M: SMIS-CSNR 43241. Raport 6, 284 p., <https://natura2000cluj.files.wordpress.com/2015/04/raport-6.pdf>.*

## PLANT ASSOCIATED MICROORGANISMS WITH SILICA SOLUBILIZATION POTENTIAL

### MICROORGANISME BENEFICE PLANTELOR CU EFECT DE SOLUBILIZARE A SILICIULUI

**BOIU-SICUIA Oana-Alina<sup>1\*</sup>, BURLACU Aglaia<sup>1</sup>, ISRAEL-ROMING Florentina<sup>1</sup>, VOAIDEȘ Cătălina<sup>1</sup>, CORNEA Călina Petruța<sup>1</sup>**

\*Corresponding author e-mail: sicuia\_oana@yahoo.com

**Abstract.** Silicon is the second abundant element on Earth. Commonly, it is found as silica and silicates, or in biology as mineral constituent of microorganisms, protozoa and plants. Although silicon it is not considered an essential nutrient for plants, it has been noticed that available silicon positively influences plants' growth, mechanical strength, and resistance to several biotic and abiotic unfavorable conditions, such as fungal phytopathogens, herbivores and adverse chemicals. Our study presents several microbial strains able to solubilize silicon from different biological and mineral substrates. Some of these microorganisms were isolated from plant material with high content of mineral silicon like horsetail, wheat straw, rosemary and nettle. Moreover, microbial supernatant obtained on horsetail broth increased hypocotyl and roots length of cowpea *Vigna unguiculata* (L.) Walp.

**Key words:** plant beneficial microorganisms, silica solubilization

**Rezumat.** Siliciul este cel de-al doilea element de pe pământ din punct de vedere al abundenței. Acesta se regăsește cel mai adesea sub formă de silicați și silice, sau constituent mineral în microorganisme, protozoare și plante. Deși siliciul nu este considerat un nutrient esențial pentru plante, s-a observat că prezența siliciului în forme solubile influențează în mod pozitiv creșterea plantelor, rezistența mecanică și îmbunătățește rezistența la factorii biotici și abiotici nefavorabili, cum ar fi atacul fungilor fitopatogeni, erbivorele și substanțele chimice adverse. Studiul de față prezintă o serie de microorganisme capabile să solubilizeze siliciul prezent în diferite substraturi organice sau minerale. Unele dintre acestea fiind izolate din material vegetal bogat în siliciu, precum coada calului, paiele de grâu, rozmarinul și urzica. Mai mult decât atât, s-a observat că supernatantul microbial obținut pe decoct de coada calului stimulează creșterea plântuțelor de fasoliță *Vigna unguiculata* (L.) Walp.

**Cuvinte cheie:** microorganism benefice plantelor, solubilizarea siliciului

## INTRODUCTION

Silicon (Si) is an abundant element in nature. In plants growth, it is considered as a non-essential element. However, it is accumulated in up to 1% in

---

<sup>1</sup> University of Agricultural Sciences and Veterinary Medicine Bucharest, Romania

dicotyledonous plants, up to 5-10% in monocots (like rice) and wetland grasses, or it can reach 25% in *Equisetaceae* (Epstein, 1994). Some plants, such as green onion (*Allium cepa*), pepper (*Capsicum* sp.), radish (*Raphanus sativus*), and tomato (*Lycopersicon esculentum*), accumulate silicon in their roots, but have a low quantity of Si in their shoots (Tubana *et al.*, 2016). Silicon is absorbed by plants only as silicic acid (Luyckx *et al.*, 2017). However, plants ability to absorb this element is differentiated among species. This property seems to be driven by the differences in the cell wall types (Yokoyama and Nishitani, 2004) where Si has a structural importance in type II cell walls, compared to the type I cell walls of dicots. Moreover, studies carried out by Deshmukh *et al.* (2015) revealed that a specific type of plant aquaporins, with a precise distance of 108 amino acids between the asparagine-proline-alanine domains, enable Si absorption in species that possess this NIP-III aquaporins (Deshmukh *et al.*, 2015).

It has been demonstrated that available silicon positively influences plants' growth, mechanical strength, and resistance to several biotic and abiotic unfavorable conditions. Studies regarding this aspect evidenced that silicic acid primes the defense response in both Si-accumulators and non-accumulator plants (Detmann *et al.*, 2012, 2013; Ghareeb *et al.*, 2011; Luyckx *et al.*, 2017).

Due to the proven effects of Si in plant growth and stress mitigation, the microorganisms that can convert an insoluble silicon source into silicic acid are of great interest.

Microorganisms able to solubilize phytosilica are relatively widespread (Vasanthi *et al.*, 2016). In the case of fungi and bacteria, it has been noticed that can grow in extremely nutrient deficient environments, including nitrogen sources, when silica compounds (such as silicagel) are present. An explanation of their growth in such conditions can be due to the ability of silicon compounds to absorb gases and volatile compounds that can then be used as sources of carbon or nitrogen by microorganisms (Wainwright *et al.*, 1997).

The aim of this study was the selection and characterization of some microbial strains with silica solubilization abilities.

## MATERIAL AND METHOD

For the isolation of phytosilica solubilizing microorganism we used water-based macerates of horsetail (*Equisetum arvense*), wheat straw (from *Triticum aestivum*), rosemary (*Rosmarinus officinalis*) and nettle (*Urtica dioica*), maintained at room temperature for three days. An amount of 100  $\mu$ l suspension of each macerate was inoculated on Bunt and Rovira agar medium containing 0.25% silica gel or talc, and also on glucose - agar medium supplemented with 0.25% silica gel or talc. After one week incubation at 28°C, the colonies emerged on this media were analyzed for their ability to solubilize silicon by revealing a clarified halo on Bunt and Rovira agar medium supplemented with 0.25% of silica gel, talc or diatomite. Bacterial strains revealing clear halos surrounding their colonies were identified through Biolog Gen III technique.

New isolated microorganisms as well as other bacterial and fungal strains were analyzed for their ability to solubilize silicon from silica gel, an insoluble Si-compound.

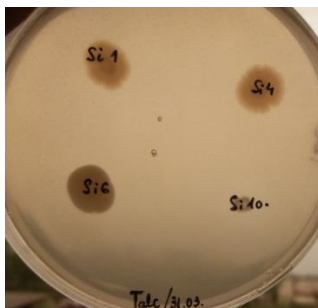
The amount of silicic acid released from the solubilization process was quantified using the Spectroquant kit (Merck). Microbial strains used in this experiment included five newly isolated strains of *Burkholderia fungorum* (Si1, Si4, Si17, Si18b and Si24), five strains of *Bacillus* sp. (BW, BIR, B5, OS15 and OS17), five strains of *Pseudomonas* spp. (Ps 8/2/3, P6, P8, P9, P22), and five fungal strains of *Trichoderma* spp. (Td2, TK14, TK20, TK27 and T36). All of these microbial strains were grown in liquid Bunt and Roviramedium supplemented with 0.25% silica gel. Centrifuged culture supernatant was then used to determine solubilized Si content as silicic acid. The quantitative determination was made in presence of sulfuric acid, when silicate and molybdate ions are reduced to silicomolibdate, a blue compound determined spectrophotometrically at 400 nm.

In order to evaluate the effect of released phytosilica on the germination and growth of cowpea seedlings (*Vigna unguiculata*), five fungal strains of *Trichoderma* sp. (Td2, TK14, TK20, TK27 and T36) were grown in 1% sterile *Equisetum arvense* herba prepared in distilled water. After 7 days of incubation at room temperature, culture supernatants were filtered through Whatman no.1 filter paper and sterile membranes of 0.22  $\mu\text{m}$  porosity. Disinfected cowpea seeds were then placed on Water-Agar substrate supplemented with 5 and 10% microbial filtered culture-supernatant obtained on horsetail broth. Seeds germination was evaluated after 3 days of incubation at room temperature, and roots and hypocotyls were measured.

## RESULTS AND DISCUSSIONS

A total number of 24 bacterial colonies and two fungal colonies were detected to be surrounded by clear halos on the silica gel medium (fig. 1).

A remarkable aspect among the bacterial isolates obtained from horsetail macerate is their high capacity to solubilize tricalcium phosphate from Pikovskaya agar medium (fig. 2).



**Fig. 1** Bacterial colonies on Bunt and Rovira medium with 0.25% talc. Light clear halos can be seen around Si1, Si4 and Si10 colonies suggesting talc solubilizing activity

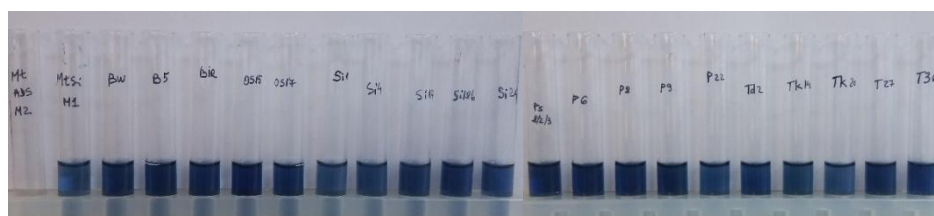


**Fig.2** Phosphate solubilizing bacteria (isolates Si1, Si4 and Si10) on Pikovskaya agar medium.

The identification of the newly isolated Si-solubilizing bacteria revealed that Si1, Si4, Si10, Si17, Si18b and Si24 strains belong to *Burkholderia fungorum*, with a probability of 95.5 to 96.8%, according to Biolog Gen III ID

system. The two fungal strains with Si-solubilizing activity were identified as *Fusarium* species, based on their colony morphology and microscopic aspect.

Among the newly isolated strains only five of them were maintained, due to their cultivation capacity. These strains of *Burkholderia fungorum* (Si1, Si4, Si17, Si18b and Si24), along with other ten bacterial strains of *Bacillus* spp. (BW, BIR, B5, OS15 and OS17), *Pseudomonas* sp. (Ps 8/2/3, P6, P8, P9, P22) and five fungal strains of *Trichoderma* sp. (Td2, TK14, TK20, TK27 and T36) were forwardly analyzed. Silicic acid was then quantified in the microbial culture supernatant (fig. 3), after 7 days of incubation on insoluble silica gel supplemented substrate.



**Fig. 3** Differences in silica gel solubility among the tested microbial strains (legend within the text)

Table 1

**Fungal and bacterial strains capacity to solubilize Si from silica gel**

Crt no.	Microbial strain	$\mu\text{g} / \text{mL SiO}_2$
1	<i>Bacillus amyloliquefaciens</i> BW	2.96
2	<i>Bacillus</i> sp. B 5	5.024
3	<b><i>Bacillus</i> sp. BIR</b>	<b>6.856</b>
4	<i>Bacillus</i> sp. OS 15	5.536
5	<b><i>Bacillus amyloliquefaciens</i> OS 17</b>	<b>5.96</b>
6	<i>Burkholderia fungorum</i> Si 1	4.224
7	<i>Burkholderia fungorum</i> Si 4	3.904
8	<i>Burkholderia fungorum</i> Si 17	4.904
9	<i>Burkholderia fungorum</i> Si 18b	4.472
10	<i>Burkholderia fungorum</i> Si 24	4.584
11	<i>Pseudomonas fluorescens</i> Ps 8/2/3	4.568
12	<b><i>Pseudomonas</i> sp. P 6</b>	<b>7.704</b>
13	<b><i>Pseudomonas</i> sp. P 8</b>	<b>7.176</b>
14	<i>Pseudomonas</i> sp. P 9	5.2
15	<i>Pseudomonas</i> sp. P 22	3.88
16	<i>Trichoderma</i> sp. Td 2	4.416
17	<b><i>Trichoderma</i> sp. Tk 14</b>	<b>7.664</b>
18	<i>Trichoderma</i> sp. Tk 20	3.328
19	<b><i>Trichoderma</i> sp. T27</b>	<b>5.848</b>
20	<i>Trichoderma</i> sp. T36	4.832
	Control (uninoculated culture supernatant)	2.744

Among the twenty microbial strains tested, different amounts of silicic acid were quantified (tab. 1). The most effective strains in Si-solubilization were *Bacillus* sp. BIR and OS17, *Pseudomonas* sp. P6 and P8, *Trichoderma* sp. Tk14 and T27 strains. These results suggest that, in most cases, the ability of microorganisms to grow on media with insoluble silicon form is associated with silicon solubilization and extracellular silicate accumulation.

Regarding the effect of microbial released phytosilica on the germination cowpea seeds, no differences were noticed among the experimental variants. The germination percentage of cowpea seeds was 100%. However, when roots and hypocotyls were measured, results showed that all microbial treatments stimulated the vegetative growth of the cowpea seedlings (fig. 4), except for T27 strain (in both concentrations), and Tk20 strain (in 10% concentration).

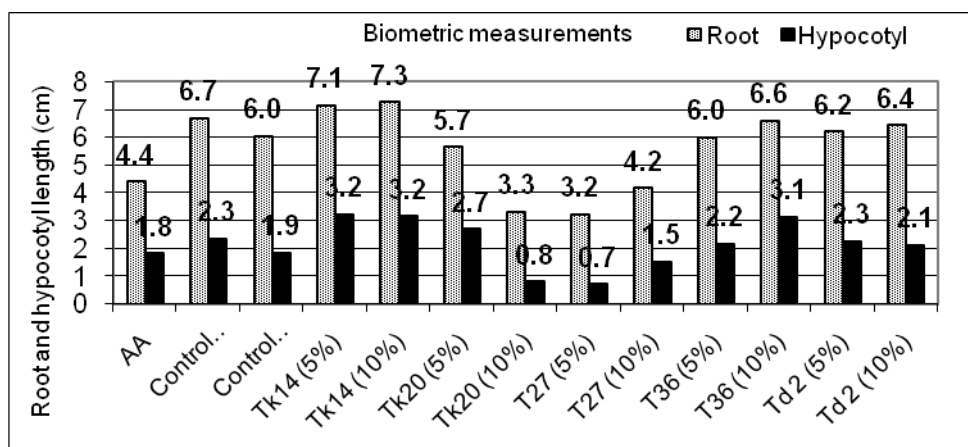


Fig. 4 Biometric evaluation of cowpea seedlings

Best results were obtained with Tk14 strain, with insignificant differences between the two tested concentrations.

## CONCLUSIONS

New bacterial strains belonging to *Burkholderia fungorum* and *Fusarium* sp. were selected for their ability to solubilize phytosilica, silica gel, talc and diatomite.

Silicic acid quantification performed on 20 microbial cultures revealed the high Si-solubilizing activity of *Bacillus* sp. BIR and OS17 strains, *Pseudomonas* sp. P6 and P8 strains, and *Trichoderma* sp. Tk14 and T27 strains. These microbial strains released 5.8 to 7.7  $\mu\text{l SiO}_2/\text{mL}$ .

Microbial solubilization of phytosilica from *Equisetum arvense* herba has a positive influence on cowpea seedlings growth.

**Acknowledgments:** This work was supported by ERA-IB-15-129/2016 project (ConvertSi).

## REFERENCES

1. **Deshmukh R.K., Vivancos J., Ramakrishnan G., Guérin V., Carpentier G., Sonah H., Labbé C., Isenring P., Belzile F.J., Bélanger R.R., 2015** - *A precise spacing between the NPA domains of aquaporins is essential for silicon permeability in plants.* Plant Journal, 83(3):489-500. doi: 10.1111/tpj.12904.
2. **Detmann K.C., Araújo W.L., Martins S.C., Fernie A.R., Damatta F.M., 2013** - *Metabolic alterations triggered by silicon nutrition: is there a signaling role for silicon?* Plant Signal. Behav. 8:e22523. doi: 10.4161/psb.22523.
3. **Detmann K.C., Araújo W.L., Martins S.C., Sanglard L.M., Reis J.V., Detmann E., et al., 2012** - *Silicon nutrition increases grain yield, which, in turn, exerts a feed-forward stimulation of photosynthetic rates via enhanced mesophyll conductance and alters primary metabolism in rice.* New Phytol. 196, 752–762.
4. **Epstein E., 1994** - *The anomaly of silicon in plant biology.* Proceedings of the National Academy of Sciences USA, 91:11-17.
5. **Ghareeb H., Bozsó Z., Ott P.G., Repenning C., Stahl F., Wydra K., 2011** - *Transcriptome of silicon-induced resistance against Ralstoniasolanacearum in the silicon non-accumulator tomato implicates priming effect.* Physiol. Mol. Plant. Pathol. 75, 83–89.
6. **Luyckx Marie, Hausman J.F., Lutts S., GuerrieroGea, 2017** - *Silicon and Plants: Current Knowledge and Technological Perspectives.* Frontiers in Plant Science. 8:411. doi: 10.3389/fpls.2017.00411.
7. **Tubana Brenda S., BabuTapasya, Datnoff L.E., 2016** - *A Review of Silicon in Soils and Plants and Its Role in US Agriculture: History and Future Perspectives.* Soil Science, 181 (9/10). doi: 10.1097/SS.000000000000179.
8. **Wainwright M., Al Wajeeh K., Grayston S.J., 1997** - *Effect of silicic acid and other silicon compounds on fungal growth in oligotrophic and nutrient-rich media.* Mycological Research, 101 (8): 933-938.

## IMPROVEMENT OF *DAYLILIES* (*HEMEROCALLIS* L.) IN THE REPUBLIC OF MOLDOVA

### AMELIORAREA CRINULUI GALBEN (*HEMEROCALLIS* L.) ÎN REPUBLICA MOLDOVA

MANOLE Svetlana<sup>1\*</sup>

\*Corresponding author e-mail: smanole2003@yahoo.com

**Abstract.** The genus *Hemerocallis* L. has long been attributed to the Liliaceae family, then to the Hemerocallidaceae family. Since 2009, on the basis of phylogenetic analyzes, it has been attributed to the Xantorrhaceae family. The species of *Hemerocallis* are spread in the temperate zones of Oriental Asia, especially in China, in the peninsula of Korea, Japan, Siberia. The most northern species can be considered *Hemerocallis lilioasphodelus* or *H. flava*, which is found in the Obi river basin and in Western Siberia. The genus *Hemerocallis*, the species *H. flava*, *H. fulva* are characteristic for the flora of Europe. Many species of this family are grown as ornamental ones. The paper presents the results of the improvement of the species and varieties of the genus *Hemerocallis* L., the methods and stages of obtaining some forms and varieties of *Hemerocallis hybrida* Hort., the forms of *Hemerocallis hybrida* Hort., with decorative qualities superior to the parent plants.

**Key words:** *Hemerocallis*, species, varieties, improvement, methods of improvement, new forms, morphology, phenology

**Rezumat.** Genul *Hemerocallis* L. a fost mai mult timp atribuit familiei Liliaceae, apoi familiei Hemerocallidaceae. Din 2009 a fost acceptat, pe baza unor analize filogenetice, la familia Xantorrhaceae. Speciile genului *Hemerocallis* sunt răspândite în zonele temperate a Asiei orientale. În special în China, peninsula Coreea, Japonia, Siberia. Cea mai nordică specie poate fi considerată *Hemerocallis lilioasphodelus* sau *H. flava* ce se întâlnește în bazinul râului Obi și Siberia occidentală. Pentru flora Europei din genul *Hemerocallis* sunt caracteristice speciile *H. flava*, *H. fulva*. Multe specii ale acestei familii sunt cultivate ca ornamentale. În lucrare sunt prezentate rezultatele ameliorării speciilor și soiurilor din genul *Hemerocallis* L., metodele și etapele căpătării unor forme și soiuri de *Hemerocallis hybrida* Hort., formele de *Hemerocallis hybrida* Hort. cu calități decorative superioare formelor parentale.

**Cuvinte cheie:** *Hemerocallis*, specii, soiuri, ameliorare, metode de ameliorare, forme noi, morfologie, fenologie

## INTRODUCTION

The name of the *Hemerocallis* genus was given in 1753 by Swedish botanist Carl Linnaeus in his first publication "Species plantarum".

<sup>1</sup>State Agrarian University of Moldova, Republic of Moldova



The genus *Hemerocallis* L. has long been attributed to the family Liliaceae, then to the Hemerocallidaceae family, this fact is stated in the literature. Since 2009, on the basis of phylogenetic analyzes, it has been attributed to the Xanthorrhoeaceae family which is divided into 3 subfamilies of Hemerocallidoideae, Asphodeloideae and Xanthorrhoeoideae. Family representatives have a wide geographical distribution, although they are predominantly found in tropical and temperate regions of the globe. Many species of this family are grown as ornamental ones.

The species of *Hemerocallis* are spread in the temperate zones of Oriental Asia, especially in China, in the peninsula of Korea, Japan, Siberia. The most northern species can be considered. *Hemerocallis lilioasphodelus* or *H. flava*, which is found in the Obi river basin and in Western Siberia. The genus *Hemerocallis*, the species *H. flava*, *H. fulva* are characteristic for the flora of Europe (Седельникова, Челтыгмашева, 2017).

At present, 19 species of the genus *Hemerocallis* are described by various authors: *Hemerocallis aurantiaca* Baker; *H. fulva* L.; *H. disticha* Donn.; *H. longituba* Miq.; *H. Dumortieri* Morr.; *H. Middendorffii* Trautv. et. Miq.; *H. esculenta* Koidz.; *H. pedicellata* Nakai.; *H. flava* L.; *H. minor* Mill.; *H. sulphurea* Nakai.; *H. Thunbergii* Baker.; *H. citrina* Baroni.; *H. coreana* Nakai.; *H. Forrestii* Diels.; *H. nana* Forreest. et Smith.; *H. plicata* Stapt.; *H. multiflora* Stoun.; *H. exaltata* Stout. (Stout, 1930; Turcinscaia, 1973).

*Hemerocallis* or Daylily is represented in the contemporary ornamental horticulture by older varieties from the 40s-50s. There are fewer varieties of the 70's of the 20<sup>th</sup> century. The most contemporary varieties are the tetraploid, of American selection. In Europe, the most common varieties of *Hemerocallis* are the hybrid forms - very precious in ornamental terms.

Its foliage determines the overall appearance of the plant.

The plants get the most spectacular aspect during flowering. Most varieties bloom between 30-45 days, some varieties up to 60 days.

The right choice of varieties in green spaces can ensure their decorative aspect up to 60-75 days. Flowers have a special role in ensuring the decorative aspect to the space because they contain a wide range of different shades of yellow, orange, red, pink, purple.

Some species or *Hemerocallis* varieties, especially those with yellow flowers, have a fine flavor. The Daylily can be successfully used in interior design. The character of its growth and development, in this context, determines the types of propagation to the Daylily the biological properties are important.

In the collection of ornamental plants of the National Botanical Garden (Institute) "Alexandru Cibotaru", 5 species, 17 international selection varieties and 9 national selection varieties are currently registered. The research on their biological peculiarities has taken place over longer periods of time. The study focused on biomorphological features, ornamental qualities, and vegetative productivity.

The research activity has been going on for many years in the direction of enriching the *Hemerocallis* collection in both species and varieties. Based on the existing collection, works have been carried out to improve, to obtain new forms. In

the result of crossbreeding, more ornamental forms were obtained, 9 of which were certified as ornamental plant species.

## MATERIAL AND METHOD

Under the conditions of the Republic of Moldova, Daylily does not form seeds without artificial pollination. The generation obtained from seeds is not uniform, so generative multiplication can be used for the amelioration and acquisition of new forms and varieties.

In order to obtain new forms, hybrids and varieties of *Hemerocallis*, we used the cross-pollination method for obtaining the first generation hybrids by their subsequent vegetative propagation. Selection methods have been adapted to local conditions as found in the specialty literature (Turcinscaia, 1973, Улановская, 2015).

The selection works were carried out by us in the direction of acquiring the varieties with diverse flowering terms from the early to the late ones and with the rebound effect while flowering. An important point is to receive the forms with a larger number of flowers in inflorescence, and tend to keep a single flower several days in bloom.

When choosing pairs for the crossbreeding, we have been guided by the ornamental qualities of these varieties: the term and duration of flowering; flower ornamental properties; the dimensions, color and silhouette of the petals; resistance to diseases and pests.

The duration of the observations allowed appreciating the quality of the obtained forms according to the following criteria: the color of the perianth, the dimensions and shape of the inflorescence axis, the resistance, the shape of the inflorescence, the abundance of flowering, the decorative nature of the leaves, the shape of the bushes, the originality of the new form.

The main criterion for decorative appreciation is the color of petals. Valorous are considered flowers with vivid colors and original shapes, miniature or gigantic flowers. The traits that determine this decorative aspect are: the height of the inflorescence axis; petals: narrow, wide, wide apart between them, semi-distant, adjoining, crooked (up, down), the color of the petals (uni-, bi-color), spot (eye) at the base, or in the tip of the petal, embossed; the duration of flowering within an inflorescence and a plant; flowers with aroma and without; the flowering during the day or at night.

Appreciating the decorative nature of the bush, it is preferable for the foliage to be at a lower level than the inflorescence axes, forming a compact rosette.

Since there are no exact data on the provenance of the contemporary *Hemerocallis* varieties when choosing the paternal pairs for the crossbreeding, we have been guided by the ornamental qualities of these varieties, the main qualities being:

1. The term and duration of flowering;
2. Flower ornamental properties: size, color and silhouette of the petals;
3. Resistance to diseases and pests;
4. Having information about paternal forms.

The works are accomplished in several stages:

- a) choosing parental forms according to the convenient criteria for the final ones drawn by us;
- b) collection of pollen in test tubes with their respective marking;
- c) removing stamens from maternal forms and pollen deposition on the stigma of these flowers with the help of the brush;
- d) Labeling of pollinated flowers with date of pollination and paternal forms.

The degree of maturation of the pollen and stigma is determined visually. Pollination is more effective when it is done at the beginning of the day, in the morning between 7.00-10.00 a.m. Later on sunny space the success of pollination is lower or fertilization does not take place at all. For the daylily it is characteristic that even after the petals have closed the stigma of the pistil remains fit for fertilization at least 24 hours.

The maturing of seeds takes place within 40-50 days after the pollination. The success of pollination can be checked after 4-5 days. If the fertilization did not take place, the ginkgo (gineceul) falls down with the flower bloom, in the positive case the ovary grows significantly in size, forming the fruit - capsule, in which the seeds gradually mature. Once the seeds mature, the capsule changes color from green to light brown. The right time for seed collection is when the color of the capsule turns light - brown and the valves start to open.

The seed capsules were collected until the seeds were completely matured (beginning of bleaching), and we fully cut the inflorescence. It was stored in canvas bags, hung on supports (suspended) in a dry and well-ventilated room.

The seeds are black with brown or blue shades, they quickly lose their ability to germinate, and that's why we've sown them the same autumn or the following spring.

Seeds in soil germinate rapidly. They were sown directly in the ornamental sector on separate plots. The depth of soil incorporation was 1.5-2 cm. The young plants were transplanted at a distance of 30-40 cm in rows with a distance of 40 cm between them at the end of the first growing season. At the first flowering the most decorative forms were described and chosen.

During the observation period the plants that were weak or injured by diseases or pests were eliminated.

The final appreciation of all the components of the decorative aspect of the obtained forms was made in the 5th and the 6th year.

The duration of the observations allowed to appreciate the quality of the obtained shapes by the following features: the color of the perianth, the dimensions and shape of the inflorescence axis, the resistance, the shape of the inflorescence, the abundance of flowering, the decorative nature of the leaves, the shape of the bushes, the originality of the new form.

The main criterion for decorative appreciation is the color of petals. Valuable are considered the flowers with vivid colors and original forms.

The traits that determine this decorative aspect are:

1. The height of the inflorescence axis;
2. Petals: narrow, wide, wide apart between them, semi-distant, adjoining, crooked (up, down), the color of the petals (uni-, bi-color), spot (eye) at the base, or in the tip of the petal, embossed;
3. The duration of flowering within an inflorescence and a plant;
4. Flowers with or without flavor;
5. Flowering during the day or at night.

Appreciating the decorative nature of the bush, it is preferable for the foliage to be at a lower level as the inflorescence axes forming a compact rosette.

## RESULTS AND DISCUSSIONS

In the process of varieties improvement, several variants of crossbreeding were made, obtaining saplings, which were selected and repaired. The most successful variants were planted in the homologation sector. Currently, the forms that have the

highest degree of appreciation have been obtained from multiple crossbreeding of the following varieties:

**Pink Lightning** –the color of the yellow pink petals, at the base with a yellow-golden spot. The broad petals, heavily embossed, at the outer peaks are bent inside. Light green, semi-curved rosette leaves. The inflorescences are higher than the leaf rosette.

**Chipper Cherry** –dark red petals, with a small yellow spot at the base. The petals are wide open with a slightly curled edge. The leaves are green-dark, 2.5-3 cm wide, at the same level with the flowers.

**Angel Mine** –dark pink petals, with a more intense colored greenis spot at the base. The edge of the petals is slightly wavy. The leaves are dark-green, about 4 cm wide, at the same level with the flowers.

**Iveria** –orange yellow petals, anthers of the same color as petals, semi-closed corolla. Light green, semi-curved green rosette leaves. The inflorescences are higher than the leaf rosette.

**Missouri Beauty** –yellowish-green flower. Petals semi closed, the inner ones wide with the rim heavily embossed up to half of the petal. The leaves in the rosette are narrow, light green, semi-curved. The inflorescences are higher than the leaf rosette.



*Hercules*



*Iveria*



*Chipper Cherry*

**Fig. 1** Varieties initiated in improvement (author's photo)

**Ciombe**-variety with claret – dark flowers, narrow petals, rolled, and golden – yellowspot. Diameter 16 cm. Average flowering.

After the improvement works carried out during the years (1989-2016), several hybrids of daylily have been chosen, which were planted in the approved sector of the National Botanical Garden "Alexandru Cibotaru". The initial forms were cultivated in this sector and as a result of the approval the following forms were chosen which received their own names:

1. ♀ *Iveria* X ♂ *Missouri Beauty* = *Lămâița*
2. ♀ *Chipper Cherry* X ♂ *Angel Mine* = *Columna*
3. ♀ *Hercules* X ♂ *Pink Lightning* = *Coral*
4. ♀ *Chipper Cherry* X ♂ *Pink Lightning* = *Avântul*
5. ♀ *Chipper Cherry* X ♂ *Pink Lightning* = *Farmec*
6. ♀ *Angel Mine* X ♂ *Chipper Cherry* = *Melancolie*
7. ♀ *Chipper Cherry* X ♂ *Ciombe* = *Zamfira*

Variety- **Lămâiță**. (plant variety patent No.356.1, 2005)

Parietal forms– ♀ Chipper Cherry x ♂ Angel Mine.

Compact bush with a medium degree of leaves growing. Linear-narrow leaves with arched, light-colored tops. The floral shaft reaches a height of 70-90cm, smooth, dark green. Flowers have the shape of a beige-colored somber funnel, the center is light-orange and 15-16cm in diameter. The inner and outer petals are nerve-free, the inner petals are wide and embossed, the outer narrow slightly corrugated and curved. The stamens are yellow. Flowers have very fine flavor. It blooms from the second decade of June until the end of July. It is resistant to diseases and pests. Recommended for green spaces and as flowers to be cut.

Variety – **Columna** (plant variety patent No.376.1, 2006)

Parietal forms - ♀ Chipper Cherry x ♂ Angel Mine.

Compact, uniform breeches with an average degree of leaves growing. Linear-narrow leaves with arched, light-colored tops. The floral shaft reaches a height of 70-90cm, smooth, dark green. Flowers in the shape of a beige-colored somber funnel, the center is light-orange and 15-16cm in diameter. The petals have pale tan nobs. The inner petals are wide and embossed, the outer ones are narrow, slightly embossed and curved. The stamens are yellow. The flowers have very fine flavor. It blooms from the second decade of June until the end of July. It is resistant to diseases and pests. Recommended for green spaces and as flowers to be cut.

Variety—**Coral** (plant variety patent Nr.357.1, 2005)

Parietal forms—♀ Hercules x ♂ Pink Lightning.

Compact, well-rounded bush. Linear-intermediate leaves with light green arched tops. The floral shaft reaches the height of 40-60cm, smooth, dark green. Very decorative flowers in the shape of a red-lighted funnel with an orange-light center and 13-14cm in diameter. Flowers have orange-dark nobs. The inner petals of the flower have average dimensions with slightly curved edges curved downwards. The outer petals have slightly curved edges with protruding nibs. The stamens are red-orange. Flowers have a fine flavor. It blooms from the third decade of June until the end of July. It is resistant to diseases and pests. Recommended for green spaces.

Variety—**Avântul** (plant variety patent, 2006)

Parietal forms—♀ Chipper Cherry x ♂ Pink Lightning.

Compact, uniform, medium-sized bush. The linear-narrow leaves, with light green arched tops. The floral shaft reaches the height of 40-60cm, smooth, dark green. Flowers in the shape of a somber color funnel with yellow-gold center, diameter 14-15cm. Flowers have dark-colored nobs. The inner petals are wide, embossed and slightly curved. The outer petals are yellow. Flowers have a fine flavor. It blooms in the third decade of June until the end of July. It is resistant to diseases and pests. Recommended for green spaces and as flowers to be cut.

Variety – **Farmec**(plant variety patent Nr.375.1, 2006)

Parietal forms—♀ Chipper Cherry x ♂ Pink Lightning

Compact, uniform, medium-sized bush. Leaves are light green, linear-narrow, with arched peaks. Flower shaft 30-60cm high, dark green. The yellow-brick colored flowers are open in the shape of a funnel with a diameter of 14cm. The inner petals are beaded, corrugated and cherry-colored. The outer petals are straight, slightly

arched. Stamens are yellow. It blooms from the third decade of June until the first decade of August. Recommended for green spaces.

Variety-**Melancolie** ( plant variety patent No.201, 2016)

Parietal forms—♀ *Angel Mine* X ♂ *Chiper Cherry*

Larger leaves, below the inflorescences. The height at flowering 80 cm, the leaves 50 cm. Flower in the form of a large open funnel. The color of the apricot. Diameter 17 cm. The inner petals are wavy, the outer ones are sharper. At base, yellowish golden spot. Lightly fragrant flowers. Inflorescence of 5 to 7 branches, each branch has 5 flowers. Plants aged 5-6 years form from 9 to 19 inflorescences.



Fig. 2 Varieties in the sector of improvement (author's photo)

Variety- **Zamfira** (Patent for plant variety Nr.200, 2016)

Parietal forms—♀ *Chiper Cherry* X ♂ *Ciombe*

Leaves more narrow. Located almost at the same height with inflorescences at flowering. The height at flowering 80 cm. Flower-shaped funnel wide open lobes of sharp petals. Diameter 12 cm. Internal clamshell petals with a golden stripe in the middle. External yellow petals with claret. At the base of intense cherry contour. Inflorescence with 7 to 9 branches, each with 5 flowers. Plants of 7 to 9 years form from 20 to 35 inflorescences.



*Melancolie*



*Lămâiță*



*Zamfira*

Fig. 3 Varieties obtained by amelioration (improvement) (author's photo)

## CONCLUSIONS

1. The analysis of phenorhythm of species and varieties of the genus *Hemerocallis* L. indicates that the pace of their development is fully compatible with the climatic conditions of the Republic of Moldova. The growing season for most species and varieties is from 200 to 266 days. The blossoming of the most early species and varieties can be found in the conditions of reaching the current temperature of 220-290°C, in the morning - 970-1200°C and medium - 1700-2500°C. The flowering time and sequence depend on biological characteristics of species and varieties, lasting (20-60 days) - weather conditions.

2. We have found that the species of the genus *Hemerocallis* L. cultivated in Moldova form fruit with viable seeds, which indicates a sufficient degree of adaptation to the natural and climatic conditions of the introduction zone. It has been established that the greatest number of seeds can be obtained by artificial pollination.

3. It was noted the different capacity degree of species and varieties by vegetative propagation.

4. Pollen studies have allowed us to establish that pollen grains of all species and varieties studied in the genus *Hemerocallis* L. are elongated in the form of a pole and equator, elliptic, heteropolar, with a single distinct furrow, characterized by different morphometric characteristics. The varieties with a high content of viable pollen are distinguished, which characterizes them as resistant to the conditions in the region and which can be recommended as pollen donors to be used in breeding works.

5. The system of evaluation of *Hemerocallis hybrida* Hort varieties has been developed according to morpho-biological, decorative, propagation features.

6. Forms and varieties of *Hemerocallis* obtained under the conditions of the Republic of Moldova are resistant to diseases and pests. They have shown a high yield of propagation over the years. The period of vegetation is optimal and the plants with their foliage and flowers ensure a high decorative effect of the occupied spaces.

## REFERENCES

1. Manole Svetlana, 2001 - *Sistematica și importanța horticolă a genului Hemerocallis*. Chișinău, Biodiversitatea vegetală a republicii Moldova. Conferința societății Botanice. Editura Știința, Chișinău, p.268-272
2. Manole Svetlana, 2008 - *Soiuri autohtone de crin galben (Hemerocallis Hibrida)- pentru spații verzi*. Universitatea Agrară de Stat din Moldova. Lucrări Științifice, UASM, vol.16, Chișinău
3. Sava V., Turcan V., 2014 - *Particularitățile biomorfologice ale unor specii și soiuri din genul Hemerocallis introduse în Republica Moldova*. Mediul ambient Nr.2 (74) aprilie, p.98-10
4. Сидельникова Л.Л., Челтыгмашева Л.Р., 2017 - *Интродукция представителей рода HemerocallisL. в условиях лесостепной зоны западной Сибири*. Сборник научных трудов ГНБС, 2017, том 145, с 90-97
5. Stout A., 1930 - *Daylilies*. New-Yorc Macmillan
6. Turcinscaia A., 1973 - *Lileinichi ghibridnie*. Izdatelstvo "Mișniereba".Tbilisi. p.87
7. Зайнетдинова Г.С., Миронова Л.Н., 2011 - *Краткие итоги интродукции лилейников в Башкирии*. Научные ведомости.серия Естественные науки. 9(104), Выпуск 15/1
8. Улановская И.В., 2015 - *Биоморфологические особенности Hemerocallis hybrida hort*. Коллекции Никитского ботанического сада. Автореф. Дисс...канд. биол. Наук / Никитский ботанический сад-Научный центр- Ялта, 20 с.

## YIELD AND RESPONSE TO THE MAIN DISEASES ATTACK OF PEAR CULTIVARS AND HERITABILITY OF THE TRAITS

### PRODUCTIVITATEA ȘI RĂSPUNSUL LA ATACUL PRINCIPALELOR BOLI ALE UNOR SOIURIDE PĂR ȘI HERITABILITATEA ACESTOR CARACTERISTICI

**SESTRAS Adriana<sup>1</sup>, MILITARU M.<sup>2</sup>, TITIRICA (ANCU) I.<sup>2</sup>, DAN Cătălina<sup>1</sup>, ANDRECAN A.<sup>1</sup>, MITRE V.<sup>1</sup>, SESTRAS R.<sup>1\*</sup>**

\*Corresponding author e-mail: rsestras@gmail.com

**Abstract.** *In order to identify potential genitors for pear breeding, 17 varieties of European and Asian origin were tested for productivity and their response to pear scab (Venturiapirina) and septoria (Septoriapyricola) attack. During two consecutive years, the highest yields of pear trees were recorded for two Romanian varieties, Adria and Napoca. The best response to the pear scab and septoria diseases was recorded within Asian varieties, most of them being registered with a low degree of attack or without symptoms of attack. Some European varieties (i.e.. Doyenné du Comice, Jubileu 50), or interspecific variety Kieffer Seedling, presented also a good response to diseases. The correlation between pear scab and septoria degree of attack statistically confirmed that the susceptible varieties to scab were also sensitive to septoria, and vice versa. The broad-sense heritability coefficients for yield and response to the diseases attack varied depending on the two algorithms used, but the lowest value was registered for the trees' response to the pear scab attack, this trait being more difficult to manage in pear breeding.*

**Key words:** broad-sense heritability, correlation, genetic resources, inheritance

**Rezumat.** *În scopul identificării unor potenți genitori pentru ameliorarea părului, 17 soiuri diferite ca origine, europene și asiatice, au fost evaluate pentru productivitate și comportare la rapăn (Venturiapirina) și septorioză (Septoriapyricola). În decursul a doi ani consecutivi, cea mai mare producție de fructe s-a înregistrat la două soiuri românești, Adria și Napoca. Cea mai bună comportare la atacul celor două boli s-a înregistrat la soiurile asiatice, acestea având un grad de atac redus sau neprezentând simptome de atac. O bună reacție la boli au prezentat și unele soiuri europene (de exemplu Doyenné du Comice, Jubileu 50) sau soiul interspecific Kieffer Seedling. Corelația dintre gradul de atac cu rapăn și septorioză a confirmă statistic faptul că soiurile sensibile la rapăn au prezentat susceptibilitate și la septoria, și invers. Coeficienții de heritabilitate în sens larg, calculați pentru producția de fructe și răspunsul la atacul celor două boli, au variat în funcție de algoritmul utilizat, dar cea mai mică valoare a fost înregistrată pentru comportarea pomilor la atacul de rapăn, această caracteristică fiind mai dificil de gestionat în ameliorarea părului.*

**Cuvinte cheie:** heritabilitate în sens larg, corelație, resurse genetice, ereditate

<sup>1</sup>University of Agricultural Sciences and Veterinary Medicine, Cluj Napoca, Romania

<sup>2</sup>Research Institute for Fruit Growing Pitesti, Romania



## INTRODUCTION

Pear (*Pyrus communis* L.) is an important fruit species in areas recognized for fruit trees cultivation in the temperate climate. In order to maximize the pear culture, through the research of the pear breeding are pursued different objectives, among which are included the obtaining of productive new varieties, resistance to stress factors, especially to the attack of the main diseases (Dondini and Sansavini, 2012; Chatzidimopoulos and Pappas, 2016). The main method of pear breeding remains artificial hybridization, which involves the crossing of varieties that possess the desired characteristics, followed by selection of hybrids according to the proposed desires (Sestras, 2004; Hancock and Lobos, 2008).

In order to increase the chances of getting valuable descendants, as perspectives for the selection of new varieties, the judicious choice of genitors is essential. An appropriate choice is based on the identification of varieties that are distinguished by certain characteristics useful in pear breeding, as well as the heritability of these traits. If some adequate genitors are used in artificial pollination and if they have the ability to transmit the desired characters, the efficiency of selection in the descendancy increases considerably (Sestras, 2004; Sestras, 2018).

In the present research, 17 pear cultivars were analyzed to identify those with high productivity and properly response to the attack of two common diseases in Transylvania, Romania: pear scab (*Venturia pirina*) and septoria (*Septoria pyricola*). Although there are different information about the monogenic or polygenic inheritance of the two pear diseases (Brewer *et al.*, 2009; Liu *et al.*, 2009; Won *et al.*, 2014), in experience these characters were considered to have a polygenic determinism, so that their heritability was calculated by two algorithms, as heritability in broad-sense.

## MATERIAL AND METHOD

The biological material was represented by different varieties of pear, located in the Didactic-Experimental Collection (micro collection), from the Faculty of Horticulture, University of Agricultural Sciences and Veterinary Medicine Cluj-Napoca. The plantation was established in 2013, in a modern system, with drip irrigation and anti-hail net; the trees were conducted as slender spindle. The soil maintenance system followed the grazing interval method, a strip processed along the line, while the planting distance was 3.5 × 0.9 m. The fruits yields were analyzed, as well as the response of the trees to the main pear diseases attack: scab (*Venturia pirina*) and septoria (*Septoria pyricola*), in the third and fourth years after trees were planted, under natural conditions of infection and few phytosanitary treatments.

The statistical processing of the experimental data was performed by analysis of variance (ANOVA). When the null hypothesis was rejected, the Duncan's Multiple Range test (DMRT) was applied as a post hoc test, in order to make direct comparisons between the pairs of means of the genotypes.

In addition of statistical variance, there was performed also the genetic variance analysis. The overall (phenotypic) variance decomposition model was applied for micro-collection genotypes using a model adapted after Falconer and Mackay (1996), Sestras (2018), in which the variance between clones was considered being induced by the genotypes, while among trees (individuals) within clones was influenced by the environment (tab. 1).

Table 1

**Decomposition of overall variance (phenotypic variance) in its components (genetic and environmental variance) for apple cultivars**

Source of variation	Degree of freedom (DF)	Variance - mean sum of squares (MS)	Parameter components
Between clones - C (varieties)	C - 1	$S_C^2$	$\sigma_E^2 + n \sigma_G^2$
Within trees among clones (varieties)	C(n - 1)	$S_c^2$	$\sigma_E^2$
Total	C · n - 1	-	-

In table 1, the symbols used are the following: C = number of clones; n = number of individuals (analyzed trees) in a clone (here, 10 trees/cl);  $S_C^2$  = variance between clones (varieties), which can be equated with  $\sigma_G^2$  - genotypic variance (between varieties, because due vegetative propagation, each variety is a clone);  $s_c^2$  = variance within trees among clones (varieties), which can be equated with  $\sigma_E^2$  - environmental variance (within trees among clones/varieties variation, respectively errors variation).

Based on the model, the influence of the hereditary dowry (inheritance) of the studied traits and the phenotypic expression of the analyzed characters were evaluated, illustrated by the broad-sense heritability coefficients, computed by two formulas ( $H_a^2$  and  $H_b^2$ ) (Sestras *et al.*, 2018). The heritability in the broad-sense was calculated using  $H_a^2$  formula (1):  $H_a^2 = s_c^2 / (s_c^2 + s_e^2) = s_G^2 / (s_G^2 + s_E^2)$ . For the  $H_b^2$  formula (2), there was computed a genetic variance  $s_G^2$ , as  $s_G^2 = (S_C^2 - s_c^2) / n$ , and phenotypic variance as  $s_P^2 = S_C^2 + s_c^2$ , then the heritability in the broad-sense was calculated as  $s_G^2$  (the variance attributed to the genotype, i.e. clones, respectively varieties), divided by  $s_P^2$  ( $s_P^2 = s_G^2 + s_c^2$ ), the variance attributed to the phenotype (which is composed of the variance of genotype and variance of environment - errors). Simply, the algorithm represents the ratio of genetic variance to the overall or phenotypic variance ( $H_b^2 = s_G^2 / s_P^2$ ), i.e. highlighted the genotype participation in the phenotypic expression of a quantitative trait.

## RESULTS AND DISCUSSIONS

There were registered significant differences among the studied pear varieties, both for the production of fruits (fig.1) and for the response to the attack of the main diseases (figs.2 and 3).

The largest productions of pears were recorded at two Romanian varieties,

Adria and Napoca, obtained at Fruit Research Station Cluj (both with an average on two years of evaluation, of approximately 8.5 kg/tree). The smallest fruit production was obtained at varieties Kieffer Seedling, Gieser Wildeman and Nijisseiki, at the first two being obtained just a bit over 2 kg of fruit per tree. Because the amplitude of yields among cultivars was high, the coefficient of variability for fruit production within the 17 varieties revealed also a large variation of the trait (CV% =42.8).

The cultivar Primadona, created at FRS Cluj, showed a serious susceptibility to pear scab attack, not only as the highest level of AD%, but as significance compared to all other genotypes (fig. 2).

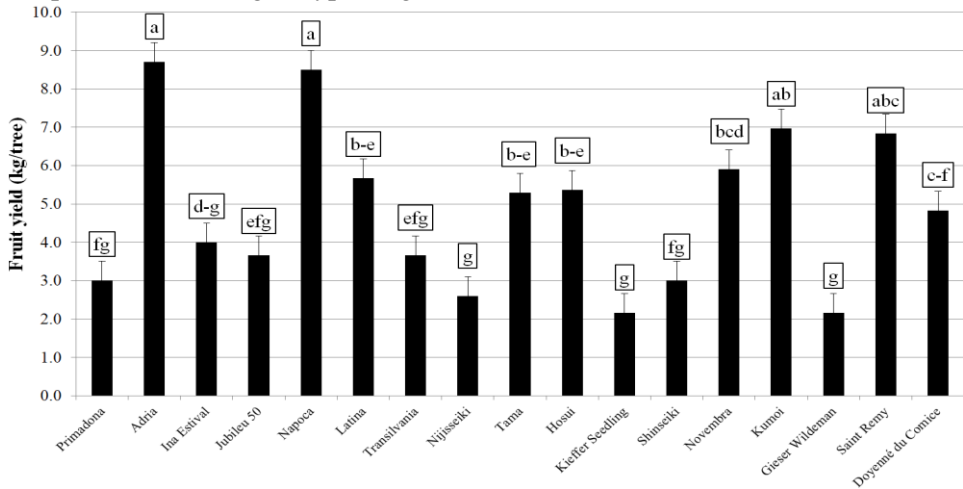


Fig. 1 Average fruit production in kg/tree at different pear varieties, in the third and fourth years after plantation

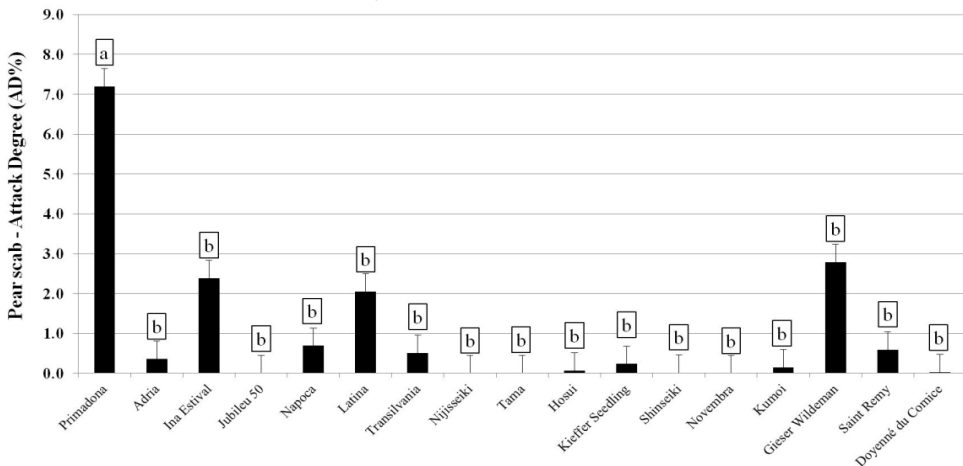


Fig. 2 The response of pear varieties to pear scab attack (as Attack Degree - AD%)

Asian varieties were recorded with a low degree of attack or were recorded without symptoms of attack. Even if the varieties Gieser Wildeman, Ina Estival and

Latinapresented an AD between 2-3%, they did not registered significant differences compared with the cultivars with the lowest attack.

Also for the septoria attack, the most susceptible variety was proved Primadona, followed by another variety created at FRS Cluj, namely Adria (fig. 3). Both European and Asian cultivars, i.e. Jubileu 50, Latina, Nijisseiki, Tama, Shinseiki, Kumoi, Gieser Wildeman, Doyenné du Comice, or hybrids between different species as origins (Kieffer Seedling), were registered without septoria symptoms during the two years survey.

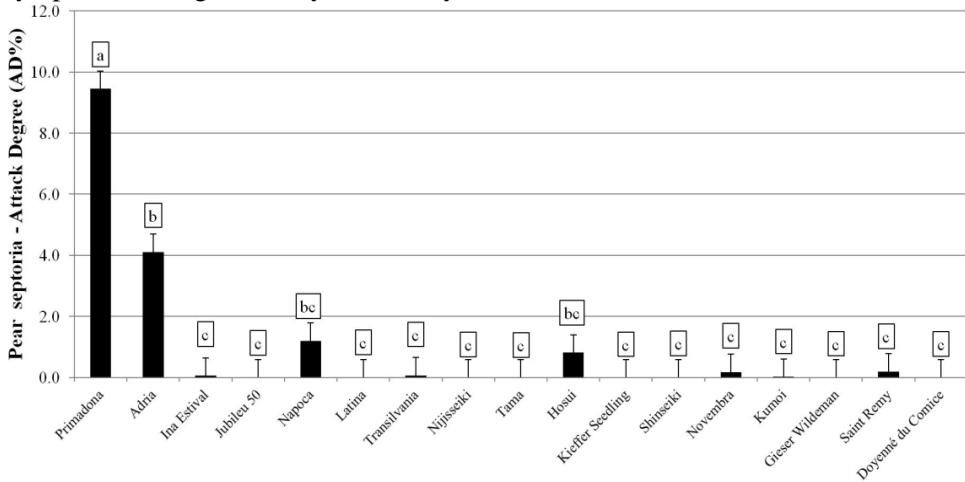


Fig. 3 The response of 17 pear varieties to pear septoria attack (as Attack Degree - AD%)

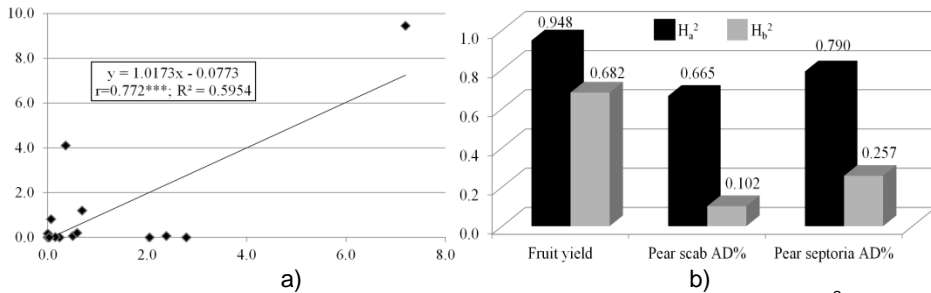


Fig. 4 (a) Regression equation (y), correlation (r) and determination ( $R^2$ ) coefficients between response of the cvs. to pear scab and septoria attack; b) broad-sense heritability coefficients for the analyzed traits, obtained by two formulas,  $H_a^2$  and  $H_b^2$

It is worth to notice that between pear scab and septoria attack there was registered a strong positive correlation ( $r=0.772***$ , fig. 4 a), which denote that, among the 17 pear varieties analyzed, the response to the attack of the two diseases was directly proportional (i.e. the susceptible varieties to scab were also susceptible to septoria, and vice versa). In addition, 59.5% from proportion of the variable variance represented by the scab response is predictable from the septoria response variance.

The broad-sense heritability coefficients for yield and response to the diseases attack of the analyzed pear cultivars, obtained by the two formulas (fig.4b) have oscillated between 0.665-0.948 ( $H_a^2$ ) and 0.102-0.682 ( $H_b^2$ ). Between the coefficients of heritability calculated for the same trait there were differences depending on the formula used. Nevertheless, regardless of the algorithm, the heritability values illustrate the lowest inheritance for the response of the trees to pear scab attack. Compared to the hereby trait, which is more difficult to use in pear breeding, fruit production seems to be more inherited, and consequently more easily to manage, in pear breeding by a proper choice of appropriate genitors.

## CONCLUSIONS

1. The existing variability among the 17 pear varieties studied allows the selection of those with the desired characteristics in order to improve the productivity or tolerance (resistance) to the two diseases: pear scab (*Venturia pirina*) and septoria (*Septoria pyricola*).

2. The heritability of the traits illustrate that pear scab seems to be more difficult to be transferred to the descendants, due to a lower contribution of additive effects in the ensemble of polygenic inheritance.

**Acknowledgments:** *The present work was supported partly by the Ministry of Agriculture and Rural Development, Romania, grants ADER 312 and ADER 321, and by ICHAT - Institute of Advanced Horticulture Research of Transylvania, UASVM Cluj-Napoca.*

## REFERENCES

1. Bell R.L., Itai A., 2011 - *Pyrus*. In: *Wild Crop Relatives: Genomic and Breeding Resources – Temperate Fruits*, C. Kole, Ed., Chapter 8, Springer, pp. 147-178.
2. Brewer L.R., Alspach P.A., Morgan C., Bus V.G.M., 2009 - *Resistance to scab caused by Venturia pirina in interspecific pear (Pyrus spp.) hybrids*. *New Zealand Journal of Crop and Horticultural Science*, 37(3), 211-218.
3. Chatzidimopoulos M., Pappas A., 2016 - *Epidemiology and control of Septoria pyricola in pear leaf and fruit*. *Journal of Plant Pathology*, 98(3), 447-452.
4. Dondini L., Sansavini S., 2012 - *European pear*. In *Fruit breeding*. Springer, Boston, MA, pp. 369-413.
5. Falconer D.S., Mackay T.F.C., 1996 - *Introduction to Quantitative Genetics*, Ed 4. Longmans Green, Harlow, Essex, UK.
6. Hancock J.F., Lobos G.A., 2008 - *Pears*. In: *Temperate Fruit Crop Breeding*. Springer, Dordrecht, pp. 299-336.
7. Liu S.M., Ye G., Richards S.M., Smith K.F., 2009 - *Segregation and transmission of host resistance to scab (Venturia pirina) in pear breeding progeny under natural infection in an orchard*. *Scientia Horticulturae*, 120(2), 222-229.
8. Sestraș F.A., 2018 – *Cercetări în ameliorarea părului*. AcademicPres, Cluj-Napoca.
9. Sestraș R., 2004 – *Ameliorarea speciilor horticole*. AcademicPres, Cluj-Napoca.
10. Silva G.J., Souza T.M., Barbieri R.L., Costa de Oliveira A., 2014 - *Origin, domestication, and dispersing of pear (Pyrus spp.)*. *Advances in Agriculture*, 541097.
11. Won K, Bastiaanse H, Kim YK et al., 2014 - *Genetic mapping of polygenic scab (Venturia pirina) resistance in an interspecific pear family*. *Molecular Breeding* 34, 2179-2189.

## GENOTYPIC COMPETENCY IN EMBRYOGENESIS AT *BRASSICA OLERACEA* MICROSPORES CULTIVATED IN VITRO

### STUDII PRIVIND COMPETENȚA GENOTIPICĂ ÎN EMBRIOGENEZA MICROSPORILOR DE *BRASSICA OLERACEA* CULTIVAȚI IN VITRO

CRISTEA Tina Oana<sup>1\*</sup>, CĂLIN Maria<sup>1</sup>, AMBARUS Silvica<sup>1</sup>,  
BREZEANU Creola<sup>1</sup>, BREZEANU P.M.<sup>1</sup>, PRISECARU Maria<sup>2</sup>

\*Corresponding author e-mail: tinaoana@yahoo.com

**Abstract.** In *Brassica* species the obtaining of doubled haploid plants is a key tool for the production of commercial F1 hybrids. Among the many methods employed for this purpose, the culture of isolated microspores offers the opportunity to generate double haploid embryos starting from single haploid cells, thus assuring the genetic purity of haploid plants obtained. The effect of donor genotype on the success of isolated microspores cultures was investigated by many authors in different cultivated species, the results demonstrate that it plays a key role. Genetic factors not only influence the viability of microspores and frequency of normal embryos but also the rate of plant regeneration. In this paper, a complete screening of microspores viability as well as embryo development under the influence of genotype is presented.

**Key words:** haploids, cabbage, *in vitro*, regeneration, plants

**Rezumat.** La speciile de *Brassica*, obținerea de plante dublu haploide este un instrument cheie pentru producerea de hibrizi comerciali F1. Dintre numeroasele metode folosite în acest scop, cultura de microspori izolați oferă posibilitatea de a genera embrioni dublu haploidici pornind de la celule haploide unice, asigurând astfel puritatea genetică a plantelor haploide obținute. Efectul genotipului donor asupra succesului culturilor de microspori izolați a fost investigat de mai mulți autori la diferite specii cultivate, rezultatele demonstrând că acesta joacă un rol cheie. Factorii genetici influențează nu numai viabilitatea microsporelor și frecvența embrionilor normali, ci și rata de regenerare a plantelor. În această lucrare este prezentată o examinare completă a viabilității microsporelor, precum și dezvoltarea embrionilor sub influența genotipului.

**Cuvinte cheie:** haploizi, varza, *in vitro*, regenerare, plante

## INTRODUCTION

Now-a-days, the microspore embryogenesis represents a unique method of single cell reprogramming in plants, through which a highly specialized cell, by specific stress treatment, switches its development towards an embryogenesis pathway.

---

<sup>1</sup>Vegetable Research and Development Station Bacău, Romania

<sup>2</sup>“Vasile Alecsandri” University Bacău, Romania

Numerous factors e.g., donor plant's genotype and physiology, microspore developmental stage, culture conditions and pretreatment affect the microspore embryogenesis (Tang *et al.*, 2003). Successful application of microspore culturing techniques for *in vitro* high-frequency plant regeneration largely depends on genotype, choice of explant, hormonal combination in the medium and other culture conditions.

The effect of donor genotype on the success of isolated microspores cultures was investigated by many authors in different cultivated species, the results demonstrate that it plays a key role. Genetic factors not only influence the viability of microspores and frequency of normal embryos but also the rate of plant regeneration (Cloutier *et al.*, 1995).

The studies also underlined the existence of so-called recalcitrant genotypes (Wang, 2009), whose microspores although cultivated under growth conditions that proved to be inductive and beneficial for other genotypes fail to generate embryos.

Thus, at *B. napus* among the many genotypes tested 'Topas' variety was identified to be the most suitable, which is also taken as a model plant, being commonly used in research work aimed at improving cultivation techniques and technologies by modifying certain parameters (Ajisaka, 1999). Also, in other species of Brassica genotypes with increased capacity of the generation of embryos, as well as the recalcitrant genotypes were identified. For example, in *B. carinata* the 19 genotypes tested on the same environmental conditions led to a highly heterogeneous response rate of embryogenesis (Chuong *et al.*, 1989).

In this paper, a complete screening of microspores viability as well as embryo development under the influence of genotype is presented.

## MATERIAL AND METHOD

The mother plants are grown in 20 cm plastic pots, in greenhouses until the stage of 10 leaves. Afterwards the plants are vernalised for 90 days in growth chambers at 4°C, in 16 h photoperiod conditions with active photosynthetic active radiation of almost 60  $\mu\text{mol m}^{-2} \text{s}^{-1}$ , and then passed into the same 16 h photoperiod but with a temperature regime of 15°C during light and 10°C during dark. The plant fertigation was accomplished weekly with liquid fertiliser (N:P:K – 20:10:20).

Since one of the most important aspects for a successful culture of microspores is the age of the donor plants, from our previous experiences we collected the biologic material from 12-14 week old plants. Thus, healthy floral buds of 3,2-3,5 mm represents the most effective biological material that can ensure a homogenous microspores population with high embryogenic competence. The excised buds were surface sterilized in 0.1% mercuric chloride (w/v) for 15 min, followed by rinsing in sterile distilled water for 3 to 4 times.

The microspore culture was initiated under sterile condition. The buds were squeezed gently with a piston taken from a 10 mL disposable syringe into a small glass vial, releasing the microspores in 10 mL NLN medium (Lichter, 1982) containing 13 g of sucrose. The suspension is filtered through a sterile 40  $\mu\text{m}$  nylon mesh and the filtrate was centrifuged 3 minutes at 200 g. The supernatant is discarded and pellet is resuspended in 10 mL medium and centrifuged again. The procedure is repeated three times. Finally, the microspores are suspended in 1-2 mL

of NLN medium and plated in petri dishes with a density adjusted to  $1 \times 10^4$  microspores/mL. The cultures are subjected to a heat stress by incubating the cultures in darkness at 33°C for three days. Following the same procedure, the renewal of the medium is accomplished after the heat shock and the culture plates are incubated to 25°C in dark for three weeks.

For the screening of the microspore viability during the early period after inoculation, the FDA (fluorescein diacetate) staining squash method was utilised. Thus, 150-300  $\mu$ l suspension with micropores is transferred in an Eppendorf tube. The volume is completed with culture medium until 1 mL and 1 mL stock solution of FDA medium is added. After 2 minutes the suspension is centrifugated and the pellet is removed. 10  $\mu$ L of suspension is used for squash sampling and observed under UV filter microscope HUND 600. The bright green cells are recorded and utilised for statistical analysis. The number of viable microspores in different stages was counted in randomly selected visual areas of the microscope in four replications per sample.

The experiments were accomplished in three replications, each one containing five plates per variant. The viability of microspores and the mean number of embryo per variant was recorded. The data were analyzed by ANOVA (analysis of variance). The means were compared using the Duncan multiple comparison test at  $P < 0.05$ .

## RESULTS AND DISCUSSIONS

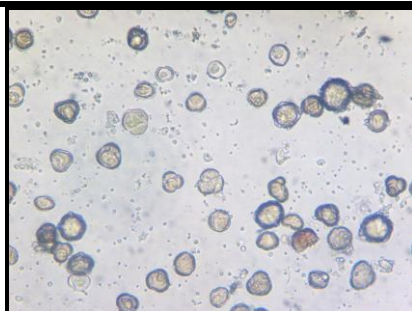
The experimental work was aimed at carrying out a study of testing a wide range of germplasm - lines, varieties and hybrids in order to determine the androgenic capacity of germplasm resources, usable in breeding activities. Thus, 16 genotypes belonging to Vegetable Research and Development Station Bacau were tested:

- lines (BCC29, BC 145, BC 228, BC 341, CCA 429, CCA 440),
- varieties (ZM 12, ZM 131, ZM 202, ZM 321, ZM 323, ZM 622),
- hybrids (D14, H19, R10 și T11).

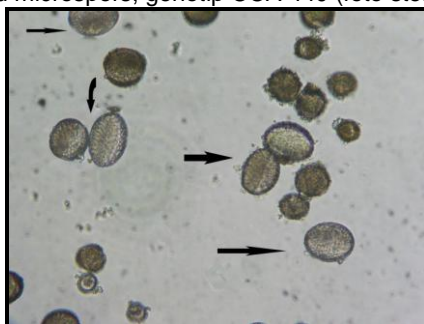
The morphogenetic response of the microspores grown under the conditions described above varied significantly, closely dependent on the donor genotype. The amplitude of this response was found between 0 embryos/petri dishes in CCA 440 genotypes and 196 embryos/petri dishes at ZM12 genotype. Of the 16 genotypes tested, very good results were obtained for ZM 202, ZM 131 and hybrids D14, R10 and T11.

Thus, plasmolyzed microspores were identified (fig. 1), small micropores but which although viable have ceased their growth and development processes, microspores with polical evolution (fig. 2), as well as microspori who have acquired embryogenic skills (fig. 3), allowing the dihaploid embryos to be obtained.

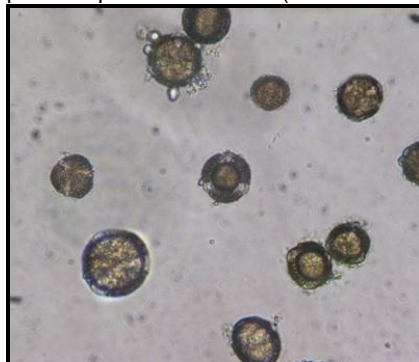




**Fig. 1** Plasmolyzed microspors, genotip CCA 440 (foto stereomicroscop – 40x)



**Fig. 2** Microspor with pollinic evolution (foto stereomicroscop 60x)



**Fig. 3** Microspor with embriogenic competence (foto stereomicroscop 60x)

Genotypic differences were also identified with respect to the percentage of viable microspores and the time period as they maintain this viability, the results obtained being synthesized in table 1.

These results confirm the theory formulated by many authors (Baro, 1999; Wang, 2009) that there is a certain genetic predisposition towards embryogenesis, a predisposition that once identified can be used in the breeding work aimed toward the transfer of this feature to genotypes with high agronomic potential, but with poor reaction to *in vitro* cultivation conditions. The viability of microsporus, registered in our work varied and in terms of the percentage of viable microspors, the minimum

threshold of 20% having a strong applicative character, leading to the identification of the morphogenetic reaction orientation of the microspore culture from early stages. The best results were found for the genotypes ZM 12, ZM131, ZM 202, ZM 622, all of which are varieties, as well as hybrid genotypes R10 and T11.

Table 1

**Evolution of microspores viability under the influence of donor plant genotype**

Nr. crt	Genotype	10 days	20 days
1	BCC 29	++	+
2	BC 145	++	+
3	BC 228	++	++
4	BC 341	++	++
5	CCA 429	+	-
6	CCA 440	-	-
7	ZM 12	+++	+++
8	ZM 131	+++	+++
9	ZM 202	+++	+++
10	ZM 321	+++	++
11	ZM 323	+++	++
12	ZM 622	+++	+++
13	D14	+++	+++
14	H19	+++	++
15	R10	+++	+++
16	T11	+++	+++

+++ - more than 20% embryogenic microspors

++ - embryogenic cells and viable microspors

+ - embryogenic cells and not viable microspors

- - without embryogenic cells, plasmolyzed microspors

At the opposite end were genotypes BC 145, BCC 29, CCA 429 and CCA 440, consanguineous lines used in breeding works at *Brassica oleracea*. For these genotypes, the viability of the microspors had a downward curve, the values being below the 20% embryogenic microspor limit.

Regarding the evolution of embryogenic microspors, it was similar to all genotypes tested, identifying pro-embryonic structures with 2-4 cells, surrounded by exine, pro-embryos with suspensory-like structures, globular embryos, heart, the torpedo and the cotyledon stage. Not all embryos with microsporal origin had a normal evolution, some of them having different physiological deficiencies (eg anthocyanic or albinism) or morphological deficiencies (incompletely developed cotyledons, short or missing hippocotal axis, lack of root, etc.).

## CONCLUSIONS

The morphogenetic response of the microspores grown under the conditions described above varied significantly, closely dependent on the donor genotype. Thus, the amplitude of this response was found between 0 embryos / petri dishes in CCA 440 genotypes and 196 embryos / petri dishes at ZM12 genotype. Of the 16 genotypes tested, very good results were obtained for ZM 202, ZM 131 and hybrids D14, R10 and T11.

These results confirm the theory formulated by many authors that there is a certain genetic predisposition towards embryogenesis, a predisposition that once identified can be used in the breeding work aimed toward the transfer of this feature to genotypes with high agronomic potential, but with poor reaction to in vitro cultivation conditions.

## REFERENCES

1. **Ajisaka H., Kuginuki Y., Shiratori M., Ishiguro K, Enomoto S., Hirrai M, 1999** - *Mapping the loci affecting the culturing efficiency of microspore culture of Brassica rapa L. syn. campestris L. using DNA polymorphism*, Breed. Science 49: 187-192.
2. **Baro F, Martin A, 1999** - *Response of different genotypes of Brassica carinata to microspore culture*, Plant Breeding 118: 78-81.
3. **Chuong P.V., Deslauriers C., Kott L.S., Beversdorff W.D., 1998** - *Effects of donor genotypes and bud sampling on microspore culture of Brassica napus*, Can.J.Bot. 66: 1653-1657.
4. **Clouttier S., Cappadocia M., Landry B.S., 1995** - *Study of microspore-culture responsiveness in oilseed rape (Brassica napus L.) by comparative mapping of F<sub>2</sub> population and two microspore-derived populations*, Theor. Appl. Genet. 91: 841-847.
5. **Lichter R., 1982** - *Induction of haploid plants from isolated pollen of Brassica napus*. E Pflanzenphysiol 105:427-434
6. **Tang G.X., Zhou W.J., Li H.Z., Mao B.Z., He Z.H., Yoneyama K., 2003** - *Medium, explant and genotype factors influencing shoot regeneration in oilseed Brassica spp.* J. Agron. Crop Sci., 189: 351-358.
7. **Wang T.T., Li H.X., Zhang J., Ouyang B., Lu Y., Ye Z., 2009** - *Initiation and development of microspore embryogenesis in recalcitrant purple flowering stalk (Brassica campestris ssp. chinensis var. purpurea Hort) genotypes.* Sci Hort 121(4):419-424.

## RADICULAR FERTILIZATIONS VS FOLIAR FERTILIZATIONS AND THEIR IMPACT ON THE CHEMICAL COMPOSITION OF PLANTS ON A TOMATO CULTURE

### FERTILIZĂRI RADICULARE VS FERTILIZĂRI FOLIARE ȘI IMPACTUL ACESTORA ASUPRA COMPOZIȚIEI CHIMICE A PLANTELOR, LA O CULTURA DE TOMATE

*PARASCHIV Luminița Nicoleta<sup>1</sup>, VOLF Mariana<sup>1\*</sup>, CHELARIU Elena Liliana<sup>1</sup>*

\*Corresponding author e-mail: mariana.volf@uaiasi.ro

**Abstract :** *The use of fertilizers correctly involves analyzing and determining the factors that condition their effect. The doses, certain stress factors, the biological features of crops, pedo-climatic conditions, the level of agri-technics applied and, last but not least, the farming system are factors that influence the level of production. The tomatoes, especially the very productive varieties, respond differently to the doses and the range of fertilizers used. The paper presents a fertilization study, in a site belonging to a family association, located in Sorogari, Iasi County. The results obtained confirm the agronomic efficiency of foliar fertilizations and combined root and foliar fertilization. During the experience, the chemical composition of tomato plants is clearly influenced by the combination of the two types of fertilizations, radicular and foliar. The production is maximum and is at the same quantitative level, equally in Borviso 500 and also 18-46 (300 kg.ha)+Borviso 500, on differentiated fertilized plot.*

**Key words :** foliar fertilizations, foliar diagnosis, macroelements

**Rezumat:** *Utilizarea de îngrășăminte în mod corect, presupune analiza și determinarea factorilor ce condiționează efectul lor. Dozele, anumiți factori de stress, particularitățile biologice ale culturilor, condițiile pedoclimatice, nivelul agrotehnicii aplicate și nu în ultimul rând sistemul de agricultură sunt factori care influențează nivelul producțiilor. Tomatele, cu precădere soiurile foarte productive, răspund diferențiat la dozele și sortimentul de îngrășăminte folosite. Lucrarea prezintă un studiu de fertilizare, într-un amplasament aparținând unei asociații familiale, situate în Sorogari, jud. Iași. Rezultatele obținute, certifică eficiența agronomică a unor fertilizări foliare și fertilizări combinate radicular și foliar. În cadrul experienței organizate, compoziția chimică a plantelor de tomate este clar influențată de combinația celor două tipuri de fertilizări, radiculare și foliare. Producțiile sunt maxime și se situează la același nivel cantitativ, în egală măsură în varianta Borviso 500 dar și 18-46 ( 300 kg.ha)+Borviso 500, pe agrofonduri diferențiat fertilizate.*

**Cuvinte cheie:** fertilizare foliară, diagnoză foliară, macroelemente

---

<sup>1</sup> University of Agricultural Sciences and Veterinary Medicine Iasi, Romania

## INTRODUCTION

One of the major objectives of modern agriculture is the achievement of high and constant expectations for crops, both quantitatively and qualitatively, in the context of the real protection of agroecosystems (Rusu, 2005). The use of fertilizers in a correct and scientific way, represents a profitable and efficient measure to achieve these objectives, which together with an agrochemical control of soils and plants, leads to a substantial change in the quantity and quality of the crops. The radicular fertilizations, in addition to foliar ones, in dosages and optimized reports and in accordance with the application of the entire complex of technological links, compete for the creation of an adequate nutritional medium, but also for the harvesting of the expected level (Volf, 2008). Foliar diagnosis is an increasingly widespread process for detecting possible nutritional disturbances (Spencer and Chan, 1981) and is applicable in agricultural practice, potentiating soil analyzes and often explaining the disruptive phenomena of metabolism generated by a multitude of dysfunctions at the chemistry level of the soil.

## MATERIAL AND METHOD

The researches were carried out during the year 2017, within a private vegetable garden, located in Sorogari, Iasi County.

An area of 0.50 ha has been organized on a crop of tomato cultivar, semi-seeded variety, using a range of fertilizers, applied radicularly and foliarly. Fertilization variants were distributed in the field, according to the subdivision blocks method, with four repetitions.

There were used as radicular fertilizers, ammonium nitrate (33%), concentrated superphosphate (50%) and potassium salt (40%) in basic fertilizations in two progressive doses, respectively 425 kg / ha and 675 kg / ha. s.a. Also as a root fertilizer, in additional fertilization was also used Cx 18-46-0 complex, in single dose, 300 kg / ha s.a. For the fertilizations of organic protection (foliar) Borviso fertilizer was given in 3 runs at 3-4 week intervals in two doses, 250 mL / ha and 500 mL / ha, respectively.

The analysis of the soil type indicates the presence of mesocalcaric cambic chernozem (low leached or decarbonated), clay, developed on loessoid, undisturbed, non-irrigated deposits. The soil unit belonging to the research polygon presented:  $pH_{(H_2O)}$  6.9-7.5, neutral to slightly alkaline reaction, medium humus content (2.4-2.5% H), low to medium content in nitrates (1.9-3.9 mg  $NO_3^-$  / 100 g soil), low content in mobile phosphorus (20.8-52.8 ppm P-AL); good supply status in mobile potassium (260-301 ppm K-AL). Boron is at the lower limit of a medium insurance (0.4-0.5 ppm B)

As a biological material, Buzau tomato 1600 variety was used.

The harvesting and preparation of the vegetative organs (leaves) was done according to the standardized methodology. The time of sampling was at blossom, at the second node, the newly matured leaf. The lab analyzes on vegetative samples were aimed at:

- Determination of total nitrogen,  $N_t$  %, Kjeldahl method
- Dosing of total phosphorus,  $P_t$  %, colorimetric method with  $MoO_3$  and  $SnCl_2$
- Dosing of total potassium,  $K_t$  %, flame photometry method with atomic absorption

Production records were made by weighing and reporting per hectare.

## RESULTS AND DISCUSSIONS

The administration of fertilizers, in radicular and foliar form but also in combination, has improved the chemical composition in tomato plants. In this respect, the values of the macro-nutrient contents in the plant reflect a fairly wide range of values, indicating that they increase in relation to the type of fertilizer used and the dose (tab. 1).

The total nitrogen content of the vegetal material increases from the unfertilized control variant to the variant 18-46 (300 kg / ka) + Borviso 500, when using both plots, respectively 425 kg / ha and 675 kg / ha, for this variant – obtaining values of 6.18 and 6.50% N<sub>t</sub>, classified as state of optimal insurance (Reuter, 1986)

The total phosphorus content is at values of hidden deficit for the control variant and increases to optimal values for the rest of the variants. Borviso 500 variant and 18-46 (300 kg / ka) + Borviso 500, record comparable values on both agro-funds used.

The total potassium increases in value, progressively with the range of fertilizer used but also with the dose. Values 5.09 and 5.17% K<sub>t</sub>, for variant 18-46 (300 kg / ka) + Borviso 500, on both plots, slightly exceed the optimum, ranging from 3-5% K<sub>t</sub>, quoted in the literature.

Table 1

**The basic chemical composition % N, P and K of dry substance**

Var. /plot	150-100-175 kg/ha NPK a.s.			250-200-275 kg/ha NPK a.s.		
	Nt	Pt	Kt	Nt	Pt	Kt
	%	%	%	%	%	%
Control - unfertilized plot	5.41	0.31	2.23	5.41	0.31	2.23
18-46 ( 300 kg/ha)	5.63	0.43	3.51	5.91	0.49	3.87
Borviso 250	5.71	0.52	3.75	5.90	0.60	3.95
Borviso 500	6.12	0.65	4.98	6.45	0.69	5.04
18-46( 300 kg/ha)+ Borviso 250	6.06	0.55	4.45	6.15	0.62	4.98
18-46( 300 kg/ka)+ Borviso 500	6.18	0.65	5.09	6.50	0.68	5.17

For tomato crops in the analyzed site, the radicular and foliar fertilized variants, in combination, recorded significantly higher yields than the rest of the variants (tab 2).

For the plot 150-100-175 kg / ha NPKs.a, the maximum yields are obtained for the variant 18-46 (300 kg / ka) + Borviso 500, respectively 52050 kg / ha of fruit, with 21800 kg more than the control unfertilized variant.

For the plot 250-200-275 kg / ha NPK, the Borviso 500 and the 18-46 (300 kg / ka) + Borviso 500 variants yield largely and comparably, 60980 and 61340 kg / ha of fruit, with a difference from the control of 202% and 203%, respectively.

Table 2

**Influence of basic and additional fertilization on production**

Var. /plot	150-100-175 kg/ha NPK s.a			250-200-275 kg/ha NPK s.a		
	Prod. kg/ha	%	Dif. ±kg/ha	Prod. kg/ha	%	Differ. ±kg/ha
Control - unfertilized plot	30250	100	-	30250	100	-
18-46 ( 300 kg/ha)	45650	151	+15400	50432	167	+20182
Borviso 250	43200	143	+12950	49600	164	+19350
Borviso 500	51250	169	+21000	60980	202	+30730
18-46( 300 kg/ha)+ Borviso 250	50269	166	+20019	56800	188	+26550
18-46( 300 kg/ka)+ Borviso 500	52050	172	+21800	61340	203	+31090

## CONCLUSIONS

At the analyzed site, the tomato culture responds to the fertilization administration, thus, significant results regarding the elemental chemical composition determined by the foliar diagnosis is obtained both in the variants fertilized only foliarly, as well as at the combined variants with the radical fertilizations supplemented by the foliar ones .

By providing a rich and balanced plot in fertilizing elements for the soil belonging to the studied site, the yields are maximum and comparable for the Borviso foliar fertilized variant at 500 mL / ha but also in the combined form 18-46 (300 kg / ka) + Borviso 500, doubling in comparison with the unfertilized control type.

The Borviso foliar fertilization at the 500 mL / ha dose proves to be beneficial and effective, both by stimulating the NPK synergism processes in the soil and implicitly in the plant, as well as in stimulating the production.

## REFERENCES

1. Budoï Gh., 2001 – *Agrochimie*, Editura Didactica si Pedagogica, Bucuresti
2. Reuter D.J., 1986 – *Plant analysis, An interpretation manual*, Inkatta Press.Ltd
3. Volf Mariana, 2008 – *Agrochimie*, Editura Renaissance, Bucuresti

## THE INFLUENCE OF THE PROBABLE CLIMATE CHANGE ON THE VEGETATION PHENOPHASES ON THE MERLOT VARIETY IN THE DEALU BUJORULUI VINEYARD

### INFLUENȚA SCHIMBARILOR CLIMATICE PROBABILE ASUPRA FENOFAZELOR DE VEGETAȚIE LA SOIUL MERLOT ÎN PODGORIA DEALU BUJORULUI

ENACHE Viorica<sup>1\*</sup>, DONICI Alina, TABARANU G.<sup>1</sup>

\*Corresponding author e-mail: enacheviorica57@gmail.com

**Abstract.** *The development of vegetation and fructification phenophases in vine is determined by the cumulative action of daily average temperatures exceeding the value of 10°C, a value that is considered a biological threshold for vine. In the climatic conditions of the last few years a random evolution of the amount of active and useful temperature levels necessary to trigger the phenological stages was observed. The research was carried out during 2008-2017 on the Merlot variety in the experimental field of the Research and Development Station for Viticultural and Winemaking Bujoru. The main objective of the paper is to establish the active and useful thermal balance necessary for the development of the vegetation phenophases and the determination of the trend of their evolution. There is a slight tendency to increase the active temperature for budburst and ripening phenophases and a decreasing pronounced trend for the flowering and harvesting phenophases.*

**Key words:** vine, vegetation phenophases, active thermal balance, useful thermal balance

**Rezumat.** *Desfășurarea fenofazelor de vegetație și fructificare la vița de vie este determinată de acțiunea cumulativă a temperaturilor medii zilnice ce depășesc valoarea de 10°C, valoare ce este considerată prag biologic la vița de vie. În condițiile climatice ale ultimilor ani s-a putut observa o evoluție aleatoare a sumei gradelor de temperatură activă și utilă necesare declanșării stadiilor fenologice. Cercetările au fost efectuate în perioada 2008-2017 la soiul Merlot în câmpul experimental din cadrul Stațiunii de Cercetare Dezvoltare pentru Viticultură și Vinificație Bujoru. Lucrarea are ca obiectiv principal stabilirea bilanțului termic activ și util necesar desfășurării fenofazelor de vegetație și stabilirea tendinței evoluției acestora. Se observă o tendință ușoară de creștere a temperaturilor active pentru fenofaza de dez mugurit și părgă și o tendință pronunțată de descreștere pentru fenofazele de înflorit și maturare.*

**Cuvinte cheie:** viță de vie, fenofaze de vegetație, bilanț termic activ, bilanț termic util

## INTRODUCTION

Climate change is that climate change that is directly or indirectly attributable to human activity, which alters the composition of the atmosphere at global level, and which adds to the natural climate variability observed during

<sup>1</sup>Research and Development Station for Viticultural and Winemaking Bujoru



comparable periods. Climate change is determined by both internal and external natural or external anthropogenic factors resulting from human activities (Planul national de actiune 2016-2020). The Climatic factors influence or determine certain processes, acting directly or indirectly on vineyard culture. In the vineyard culture, first of all, interested the climatic factors of the period from April 1 to September 30, interval which overlap with the length of the vegetation period, are of interest. Global climate change is one of the major concerns of our century - a complex area where it is necessary to improve knowledge and understanding to take immediate and accurate action to tackle the cost-effective approach and challenges in this area, while respecting the precautionary principle.

## **MATERIAL AND METHOD**

The research was carried out in the experimental field of the Research and Development Station for Viticultural and Winemaking Bujoru in 2008-2017. The phenological observations were made on the Merlot variety. Data on the thermal active balance, the useful heat balance and the evolution of vegetation phenophases were analyzed and processed. The climatic data were recorded at the agrometeorological station of the resort using an AGROEXPERT system.

## **RESULTS AND DISCUSSIONS**

Weather observations and determinations was effectuated over the period 2008-2017 and compared to multiannual environments in view of the proposed objective. Air temperature is an abiotic factor that exerts a strong influence on the intensity of the physiological and biochemical processes of the vine. The influence of temperature on these processes is achieved by both its level and the sum of grades in a determined period (Alexandrescu *et al.*, 1994). Active temperature plays a decisive role in triggering vegetative phenophases. The minimum active temperature level that conditions the occurrence of phenophases in vines is called the lower threshold and the maximum level is called the higher threshold. The active and useful heat balance was calculated during the period 2008-2017, on each vegetation phenophase. In the climatic conditions of the last 10 years we can observe a random evolution of the sum of active and useful temperature required to trigger the phenological stages for the Merlot variety. The trend of the evolution of the amount of active and useful temperature grades is increasing from 2008 to 2017 for the budburst and ripening phenophases and a decreasing trend for the flowering and harvesting phases (fig.1, fig. 2). Significant deviations of active and useful temperatures for maturation were recorded in 2011 and 2014 as a result of high rainfall in August, a drastic rainfall shortage in September and the presence of high temperatures. Dynamically analyzing the evolution of the amount of active and useful temperature ranges, a change in their values required to trigger the vegetation phenophases was observed.

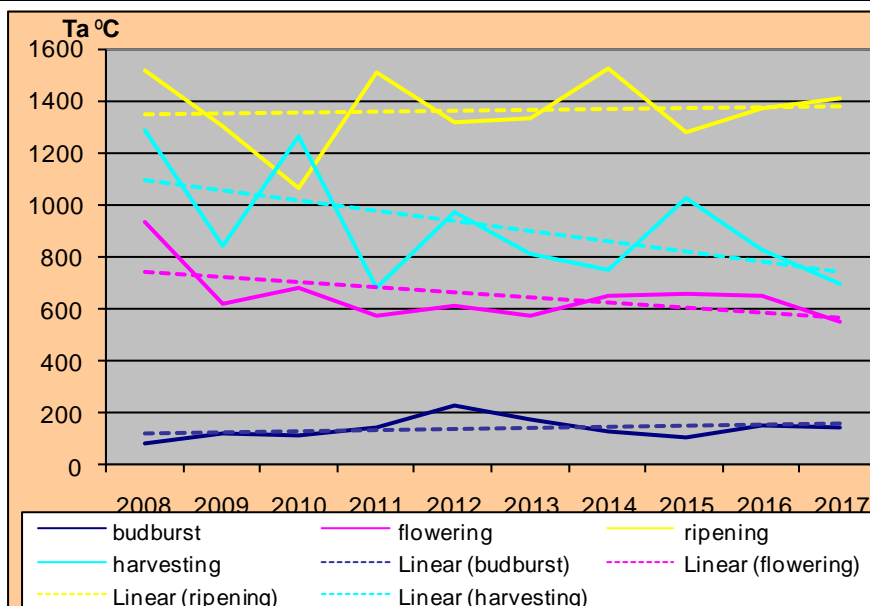


Fig. 1 Active thermal balance in the vegetation period 2008-2017

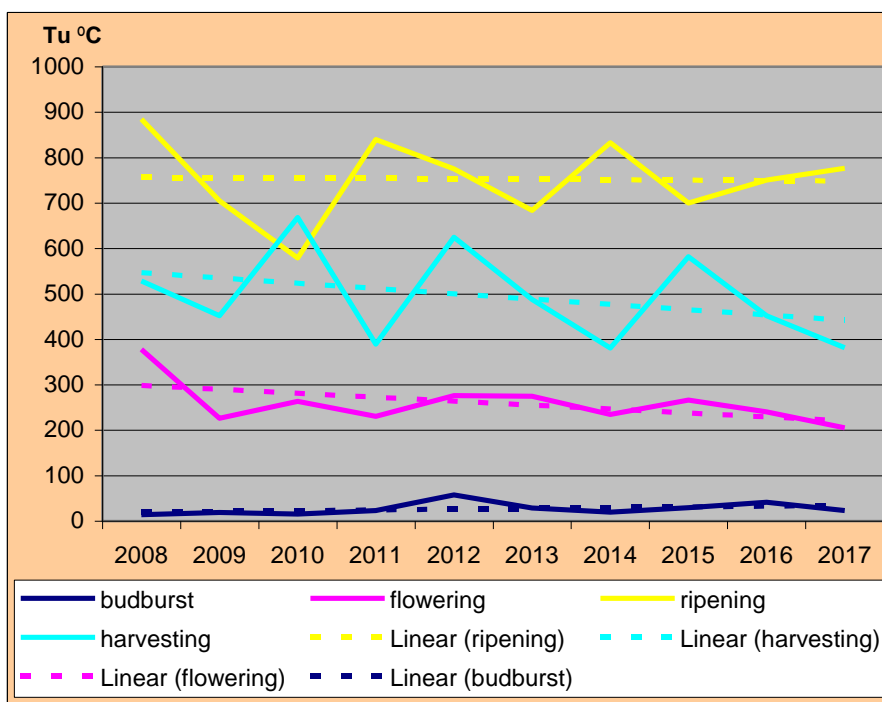


Fig. 2 Useful thermal balance in the vegetation period 2008-2017

The triggering of vegetation phenophases is directly influenced by climatic conditions (Enache, 2007). In 2008-2017 period, in general, budburst takes place in the last decade of April with the exception of 2008, 2009 and 2016, and maturity in the first and second decades of September, with the exception of 2012 when air temperatures were recorded very high in August and grape ripening took place at the end of August (tab.1). Flowering begins at the end of May, the early June (excluding 2013 year). Vegetation phenophases during the analyzed period are conditioned by a series of biological, technological and ecological factors and the response of the vine to changes in climatic factors is that the biological rhythm of growth, fructification and maturation is more alert, requiring the rethinking of vine cultivation technologies.

Table 1

**Dynamics of vegetation phenophases for Merlot variety,  
at SCDVV Bujoru during 2008-2017**

phenophase /the year	2008	2009	2010	2011	2012	2013	2014	2015	2016	2017
budburst	09.04	15.04	20.04	29.04	25.04	24.04	21.04	21.04	12.04	24.04
flowering	05.06	30.05	05.06	04.06	30.05	24.05	04.06	04.06	31.05	01.06
ripening	07.08	27.07	24.07	10.08	24.07	28.07	12.08	31.07	01.08	05.08
harvesting	17.09	03.09	22.09	12.09	28.08	09.09	17.09	14.09	08.09	07.09

## CONCLUSIONS

1. In the climatic conditions of the past 10 years, the trend of the evolution amount of active and useful temperature required to trigger the phenophases of vegetation for the Merlot variety is increasing from 2008 to 2017 for the budburst and ripening of the grapes and in decline for the flowering and maturation phases.

2. Budburst takes place in the last decade of April except for the years 2008, 2009 and 2016 and for the grapes to mature in the first and second decades of September, with the exception of 2012 when very high air temperatures were recorded in August and maturing took place at the end of August.

## REFERENCES

1. Alexandrescu I.C., Oslobeanu M., Jianu L., Pituc P. 1994 - *Mică enciclopedie de viticultură*, Editura Glasul Bucovinei, Iasi
2. Enache Viorica, 2007 - *Researches Regarding the Tendency in Some climatic factors evolution from Moldavia south hilly region with reference to viticultural plantation*, *Lucrări științifice*, Anul L, vol. 1 (50), Seria Horticultura, Editura Ion Ionescu de la Brad, p.639-642
3. \*\*\*2016 - Planul național de acțiune 2016-2020 privind schimbările climatice-  
[http://www.mmediu.ro/app/webroot/uploads/files/2015-12-04\\_Planul\\_national\\_de\\_actiune\\_2016-2020%282%29.pdf](http://www.mmediu.ro/app/webroot/uploads/files/2015-12-04_Planul_national_de_actiune_2016-2020%282%29.pdf)

## EVALUATION OF BERRY RESISTANCE TO DETACHMENT AND COMPRESSION OF SOME NEW *VITIS VINIFERA* L. CULTIVARS FOR TABLE GRAPES

### EVALUAREA REZISTENȚEI LA DESPRINDERE ȘI COMPRESIUNE A BACELOR UNOR SOIURI NOI *VITIS VINIFERA* L. PENTRU STRUGURI DE MASĂ

FILIMON V.R.<sup>1\*</sup>, FILIMON Roxana<sup>1</sup>, DAMIAN Doina<sup>1</sup>, NECHITA Ancuța<sup>1</sup>,  
ZALDEA Gabi<sup>1</sup>, ALEXANDRU C.<sup>1</sup>, BĂETU M.<sup>2</sup>, ROTARU Liliana<sup>2</sup>

\*Corresponding author e-mail: razvan\_f80@yahoo.com

**Abstract.** *Since quality requirements for table grapes are closely related to their mechanical characteristics, the aim of this work was the assessment of berry resistance to detachment from the pedicel and its resistance to compression at five new Vitis vinifera L. cultivars for table grapes: Gelu, Milcov, Napoca, Splendid and Transilvania. The determinations made on the mature berries consisted in the analysis of the normal pressing force and the deformation under its influence, as well as the force required for the detachment of berries from the pedicels, using a CETR UMT-2 tribometer. Grape berries with higher weight and volume and larger diameter (Transilvania cv.) incurred a higher mechanical deformation, while long berries (Gelu cv.) showed higher resistance to detachment from the pedicel probably due to a more pronounced development of vascular bundles, indicating a higher resistance of grapes to handling, packing, transport and storage.*

**Key words:** berry elasticity, grape quality, mechanical features, table grapes, vascular bundles.

**Rezumat.** *Întrucât caracteristicile de calitate ale strugurilor de masă sunt strâns legate de însușirile lor fizico-mecanice, scopul acestui studiu a fost evaluarea rezistenței la compresiune și detașare de pe pedicel a bachelor provenind de la cinci soiuri noi Vitis vinifera L. pentru struguri de masă: Gelu, Milcov, Napoca, Splendid și Transilvania. Determinările efectuate asupra bobelor mature au constatat în analiza forței normale de presare și a deformării suportate sub influența acesteia, precum și a forței necesare detașării bachelor de pe pedicel, folosind un tribometru automatizat CETR UMT-2. Bacele cu masă și diametru mai mare (Transilvania cv.) au prezentat o elasticitate superioară, suportând o deformare mecanică mai mare, în timp ce bacele mai alungite (Gelu cv.) au prezentat o rezistență mai mare la detașarea de pedicel, datorită unei dezvoltări mai pronunțate a fasciculelor vasculare, indicând o rezistență crescută a strugurilor la manipulare, ambalare, transport și depozitare.*

---

<sup>1</sup>Research - Development Station for Viticulture and Winemaking Iasi, Romania

<sup>2</sup>University of Agricultural Sciences and Veterinary Medicine, Iasi, Romania

**Cuvinte cheie:** caracteristici de calitate, elasticitatea bachelor, fascicule vasculare, proprietăți mecanice, struguri de masă.

## INTRODUCTION

The term *quality* implies the degree of excellence of a product or its suitability for a particular use (Abbot, 1999). Although grapes have many attributes that can be examined, the quality is not something that can be readily quantified (Creasy and Creasy, 2009). Besides visual quality and taste, when table grapes are destined for transport or storage occur a number of mechanical factors to be monitored (e.g. berry elasticity, pedicel resistance to detachment, berry skin thickness). Moreover, mechanical parameters are directly related to some sensory properties (e.g. crispness) and resistance of grapes to injury during harvest or packing (Kok and Celik, 2004; Rolle *et al.*, 2012).

In viticulture, mechanical analysis of grapes is of special interest in order to recognize the potential of each cultivar to satisfy market requirements (Rolle *et al.*, 2012). Mechanical particularities of grapes vary mainly under the influence of the genetic factor (cultivar), but other factors may intervene: climatic conditions, plant vigour, grapes position on the vine stock, the degree of ripening and grape health (Constantinescu *et al.*, 1970).

Since quality requirements of table grapes are closely related to their physico-mechanical particularities, the aim of this work was to provide relevant information concerning grapes suitability for packing, transport and storage of five new *Vitis vinifera* L. cultivars created in Romania. Scientific data obtained also contribute to a better understanding of the economic potential of the studied cultivars and their value for further breeding programs.

## MATERIAL AND METHOD

Research has been carried out on five *V. vinifera* L. cultivars for table grapes created in Romania: Gelu (free fecundation of Coarnă neagră seeds, irradiated with X rays), Milcov (Coarnă neagră × Muscat Hamburg), Napoca (Alphonse Lavallée × Regina viilor × Muscat Hamburg), Splendid (Black rose × Regina viilor) and Transilvania (Black rose × Cardinal), all growing in the Ampelographic Collection of the University of Agricultural Sciences and Veterinary Medicine Iași, Romania (27°53' E; 47°09' N). Grape harvest was conducted according to OIV/VITI 371/2010 Resolution protocol (OIV, 2010). For each cultivar 5 berry/grape were harvested from 20 grapes.

Berry length (mm) and diameter (mm) and were measured using an electronic vernier caliper, while skin thickness (mm) was measured using an outside micrometer (error ± 0.01 mm). Berry elasticity (as deformation supported by berries) and the pedicel resistance to detachment (as the force required for pedicel detachment) were performed using a single-platform, fully-computerized CETR UMT-2 tribometer. Data regarding normal and friction forces (N), deformation (mm), coefficient of friction (COF) and time of action (sec) were automatically retrieved and processed by a computer. Data were reported as mean having specified the standard deviation (±). Regression analysis was performed to look for relationships between data.

## RESULTS AND DISCUSSIONS

Transilvania cv. presented the lowest number of berries per cluster, but with the largest weight of 100 berries ( $768 \pm 32$  g). Based on the standard deviation, Splendid cv. showed a high irregularity of berry weight, followed by Transilvania and Napoca. Number of seeds was generally low, varying from 1.67 (Gelu) to 2.67 (Milcov) (tab. 1).

Table 1

Physico-structural features of grapes at technological maturity

Features	Gelu	Milcov	Napoca	Splendid	Transilvania
Berries / grape	$66 \pm 12$	$46 \pm 11$	$49 \pm 6$	$46 \pm 9$	$39 \pm 7$
100 berries weight (g)	$489 \pm 21$	$305 \pm 14$	$437 \pm 26$	$494 \pm 29$	$768 \pm 26$
100 berries vol. (cm <sup>3</sup> )	$471 \pm 18$	$296 \pm 16$	$430 \pm 19$	$485 \pm 22$	$750 \pm 25$
Rachis weight (g)	$6.29 \pm 0.12$	$3.55 \pm 0.41$	$5.85 \pm 0.71$	$5.23 \pm 0.71$	$6.80 \pm 0.48$
Seeds number	$1.67 \pm 0.58$	$2.67 \pm 0.58$	$1.67 \pm 0.58$	$2.00 \pm 1.00$	$2.00 \pm 0.00$
Skin weight (g)	$0.45 \pm 0.04$	$0.44 \pm 0.05$	$0.37 \pm 0.03$	$0.42 \pm 0.04$	$0.51 \pm 0.09$
Pulp weight (g)	$4.32 \pm 0.21$	$2.45 \pm 0.13$	$3.83 \pm 0.93$	$4.51 \pm 0.09$	$7.01 \pm 0.37$
Seeds weight (g)	$0.06 \pm 0.02$	$0.13 \pm 0.04$	$0.08 \pm 0.02$	$0.10 \pm 0.05$	$0.15 \pm 0.01$
Structure index	51.31	39.52	36.60	43.45	44.05
Composition index	8.47	4.30	8.70	8.67	10.62
Berry index	20.45	32.79	22.88	20.24	13.02

Note: Structure index - berry weight / rachis weight; Composition index - pulp weight / skin and seeds weight; Berry index - berries in 100 g. Mean values with standard deviation ( $\pm$ ).

Composition index showed lower values due to a higher weight of skin (0.37 - 0.51 g) and seeds (0.06 - 0.15 g) in relation to pulp weight, while berry index presented low values, specific to table grape cultivars. According to Constantinescu G. *et al.* (1970), the structure index presents values ranging from 12 to 50, with high values for table grapes, while the berry index has smaller values for table grape cultivars (~30).

Grape quality and its technological characteristics can be assessed by analysing the physico-mechanical particularities, obtaining important information on grape suitability for transport and storage. Mechanical measurements were performed on the mature berries and consisted in the analysis of the normal force of the compression and deformation occurring under its influence, as well as the force required to separate the berry from the pedicel. Berry weight, volume, length and diameter, and skin thickness were determined for the berries considered for the study (tab. 2).

Berry deformation (Z), the force (F) required and the time of action until cracking (T), varied significantly depending on cultivar. The most important deformations, indicating a high elasticity, were supported by Transilvania cv. berries (1.41 mm), followed by Splendid cv. (1.18 mm).

The force (Fz) applied until berry cracking was the highest at Transilvania cv., and the lowest for Milcov cv. Berries of Transilvania cv. resisted the longest time under the action of the deformation force (4.56 seconds).

The mechanical characteristics of analysed berries

Cultivar	Gelu	Milcov	Napoca	Splendid	Transilvania
Weight (g)	4.87 ± 0.15	3.01 ± 0.14	4.39 ± 0.21	4.65 ± 0.23	7.61 ± 0.37
Volume (cm <sup>3</sup> )	4.02 ± 0.22	2.87 ± 0.19	3.79 ± 0.25	3.52 ± 0.20	6.54 ± 0.14
Dimeter (mm)	17.80 ± 0.90	15.73 ± 0.31	17.93 ± 1.17	17.72 ± 0.78	18.47 ± 0.67
Length (mm)	23.90 ± 1.28	20.77 ± 0.70	20.33 ± 2.39	22.20 ± 1.39	22.17 ± 1.35
Skin thick. (mm)	0.41 ± 0.03	0.44 ± 0.05	0.27 ± 0.02	0.29 ± 0.02	0.46 ± 0.05
Fz (N)	1.41 ± 0.11	1.03 ± 0.09	2.65 ± 0.07	1.70 ± 0.11	3.46 ± 0.04
Z (mm)	0.72 ± 0.02	0.56 ± 0.01	0.53 ± 0.07	1.18 ± 0.08	1.41 ± 0.04
T (s)	2.05 ± 0.22	1.66 ± 0.19	2.34 ± 0.17	2.89 ± 0.09	4.56 ± 0.14
Ft (mN)	20.14 ± 7.11	10.08 ± 1.30	13.32 ± 3.17	15.74 ± 1.02	11.12 ± 1.42
Ff (mN)	11.51 ± 4.06	9.44 ± 1.21	4.31 ± 2.09	8.19 ± 1.34	10.44 ± 3.03
COF	0.56 ± 0.12	0.92 ± 0.10	0.31 ± 0.17	0.59 ± 0.07	0.93 ± 0.27

Note: Skin thick. (mm) - berry skin thickness; Fz (N) - normal force (Newton); Z (mm) - deformation; T (s) - time of action (seconds); Ft (mN) - tensile force (millinewtons); Ff (mN) - friction force (millinewtons); COF - coefficient of friction.

In figure 1, is plotted the dynamics of the parameters Z (decreasing due to deformation) and Fz (positive values), in relation to the time of action.

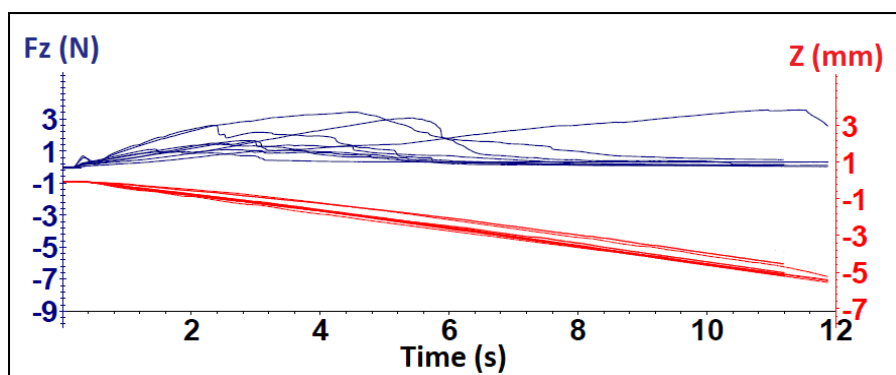


Fig. 1 Diagram of berry deformation (Z) in relation to normal force (Fz) and time of action (sec)

Note: Z (mm) - deformation (negative values due to decreasing); Fz (N) - normal pressing force (positive variations); Time (s) - time of action (seconds).

Detachment of the berries from the pedicel is triggered by the intensification of pectic and cellulase enzymes activity, this process occurring during grape maturation (Burzo *et al.*, 2005). During grape storage, at some susceptible cultivars, can be observed the undesirable phenomenon of multiple berries detachment, this negative feature being increasingly to the attention of researchers and breeders.

For the analysis of resistance to detachment, berries were cut from the rachis with a scissor, with the pedicel attached. The forces necessary to detach the berries from the pedicel were very low (10.08 - 20.14 mN). To confirm the results was necessary to analyse the force of friction (Ff) and the coefficient of friction

(COF) between pedicel brush with vascular bundles, pulp and skin, thus obtaining new clues on the moment of berry detachment (see tab. 3).

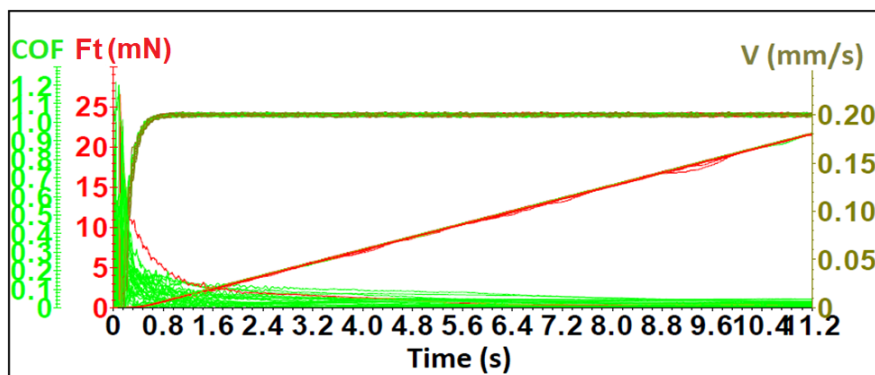


Fig. 2 Diagram of the tensile force (Ft) in relation to coefficient of friction (COF), time and speed of action (V)

Obtained data revealed that the lowest berry resistance to detachment was showed by Milcov and Transilvania cv., requiring a tensile force of 10.08 mN and 11.12 mN respectively. Analysing the force-friction-time relationship (fig. 2), was concluded that the highest resistance to detachment from the pedicel was showed by Gelu cv. berries, followed by Splendid, Napoca and Transilvania cv.

Correlation between the biometric characteristics of the berries, their elasticity (represented by the deformation incurred) and their resistance to the detachment, indicated a positive relationship between these parameters (tab. 3).

Table 3

**Correlation of the biometrical and mechanical features of the berries**

Features	Weight (g)	Volume (mL)	Diameter (mm)	Length (mm)	Skin thickness (mm)
Fz (N)	0.8360	0.8562	0.7620	-0.1426	-0.0060
Z (mm)	0.8133	0.7378	0.5738	0.3720	0.2157
T (s)	0.9432	0.9226	0.7030	0.1570	0.2245
Ft (mN)	-0.0249	-0.1554	0.3594	0.7747	-0.2549
Ff (mN)	0.3000	0.3037	-0.0678	0.7673	0.8165
COF	0.2485	0.3346	-0.3571	0.0728	0.8529

Note: Fz (N) - normal force (Newton); Z (mm) - deformation; T (s) - time of action (seconds); Ft (mN) - tensile force; Ff (mN) - friction force; COF - coefficient of friction.

According to data correlation, berries with higher weight ( $r = 0.8133$ ) and volume ( $r = 0.7378$ ) supported higher mechanical deformations. Also, the forces required were significantly higher for berries with larger diameter ( $r = 0.7620$ ).

Moreover, higher tensile and friction forces were positively correlated with berry length ( $r = 0.7747$ , and  $0.7673$  respectively), possibly due to a more pronounced development of central and peripheral vascular bundles (fig. 3).



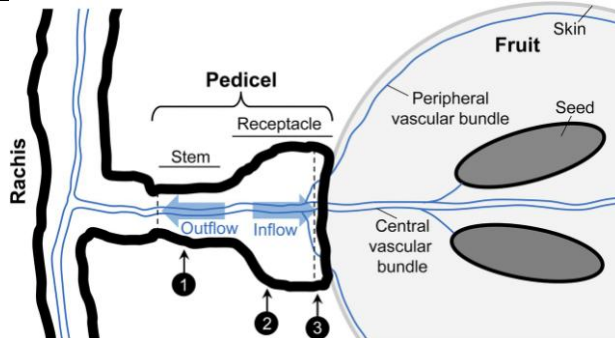


Fig. 3 Schematic drawing of berry pedicel and vascular system (Knipfer T. *et al.*, 2015)

## CONCLUSIONS

1. Grapes of new *Vitis vinifera* L. cultivars, created in Romania, showed superior physico-mechanical characteristics indicating their high quality and their high resistance to handling, packing and storage.

2. The most important deformation, indicating a high elasticity, was supported by Transilvania cv. berries, while the highest berry resistance to detachment was showed by Gelu cv., followed by Splendid and Napoca cv.

3. Data analysis showed that berries with thicker skin, higher weight and volume and larger diameter incurred a higher mechanical deformation, while elongate berries showed higher resistance to detachment from the pedicel, probably due to a more pronounced development of vascular bundles.

4. Evaluation of mechanical characteristics provides relevant data on the potential of cultivars to satisfy market requirements, particularly on the suitability of grapes to transport and storage, and their value for further breeding programs.

## REFERENCES

1. Abbott J.A., 1999 - *Quality measurement of fruits and vegetables*. Postharvest Biology and Technology, vol. 15, p. 207-225.
2. Burzo I., Dejeu L., Serdinescu A., Bădulescu L., 2005 - *Fiziologia plantelor de cultură. Vol. III, Fiziologia viței de vie*. Edit. Elisavaros, București
3. Constantinescu G., 1970 - *Ampelografia României*. Vol. I. Edit. Academiei, București.
4. Creasy G.L., Creasy, L.L., 2009 - *Grapes*. CAB Int., Cambridge.
5. Knipfer T., Fei J., Gambetta G.A., McElrone A.J., Shackel K.A., Matthews M.A., 2015 - *Water transport properties of the grape pedicel during fruit development: insights into xylem anatomy and function using microtomography*. Plant Physiology, vol. 168, p. 1590-1602.
6. Kok D., Celik S., 2004 - *Determination of characteristics of grape berry skin in some table grape cultivars (V. vinifera L.)*. Journal of Agronomy, vol. 3, p. 141-146.
7. OIV, 2010 - *OIV general form for the sensorial analysis of table grapes. Resolution OIV/VITI 371/2010*. International Organisation of Vine and Wine (OIV). Paris, France. Available online at: <http://www.oiv.int/public/medias/385/viti-2010-2-en.pdf>.
8. Rolle L., Siret R., Rio-Segade S., Maury C., Gerbi V., Jourjon F., 2012 - *Instrumental texture analysis parameters as markers of table-grape and winegrape quality: a review*. American Journal of Enology and Viticulture, vol. 63, p. 11-28.

## STUDIES ON THE PHENOTYPIC SIMILARITY OF AUTOCHTHONOUS GRAPEVINE CULTIVARS BY MEANS OF STATISTICAL-MATHEMATICAL METHODS

### STUDII PRIVIND GRADUL DE ASEMĂNARE FENOTIPICĂ DINTRE UNELE SOIURI AUTOHTONE DE VIȚĂ DE VIE PRIN UTILIZAREA METODELOR STATISTICO-MATEMATICE

*FILIMON Roxana*<sup>1\*</sup>, *FILIMON V.R.*<sup>1</sup>, *NECHITA Ancuța*<sup>1</sup>, *ZALDEA Gabi*<sup>1</sup>,  
*DAMIAN Doina*<sup>1</sup>, *ROTARU Liliana*<sup>2</sup>

\*Corresponding author e-mail: roxanacotovanu@yahoo.com

**Abstract.** Use of statistical mathematical methods in the characterization of cultivars and determination of their degree of similarity provides important information concerning cultivars appurtenance to different sortogroups, the degree of relatedness between cultivars and their differentiation. The purpose of this study was to determine the degree of phenotypic similarity between 11 autochthonous grapevine cultivars based on the physico-mechanical, biochemical and physiological characteristics of grapes and leaves, using Cluster analysis, which admits the existence of polythetic groups and allows verification of genotype belonging to a varietal faction. Group with the lowest chaining index, indicating a high phenotypic similarity, was Coarnă neagră ~ Coarnă neagră selecționată, followed by Purpuriu ~ Cetățuia and Someșan ~ Milcov groups, fact justified by their common origin within the group. A lower degree of similarity was noted between Purpuriu and Radames cultivars, with Villard blanc as common genitor, and between Transilvania and Splendid cultivars (common genitor Black rose).

**Key words:** autochthonous cultivars, chaining index, cluster analysis, genetic monitoring, principal component analysis

**Rezumat.** Utilizarea metodelor statistico-matematice în caracterizarea soiurilor și stabilirea gradului lor de similaritate oferă informații importante referitor la apartenența soiurilor la diferite sortogrupuri, precum și la diferențierea acestora. Scopul acestui studiu a fost determinarea gradului de asemănare fenotipică dintre 11 soiuri autohtone de viță de vie, pe baza caracteristicilor fizico-mecanice, biochimice și fiziologice ale strugurilor și frunzelor, utilizând analiza Cluster, care admite existența grupurilor politetice și permite verificarea apartenenței unui genotip la o grupă de soiuri. Grupul care a prezentat cea mai mică valoare a indicelui de înlănțuire, indicând asemănarea fenotipică foarte mare, a fost Coarnă neagră ~ Coarnă

---

<sup>1</sup>Research - Development Station for Viticulture and Winemaking Iasi, Romania

<sup>2</sup>University of Agricultural Sciences and Veterinary Medicine, Iasi, Romania

*neagră selecționată, urmat de grupurile Purpuriu ~ Cetățuia, și Someșan ~ Milcov, fapt confirmat de originea lor comună în cadrul grupului. Un grad redus de similaritate a fost observat între soiurile Purpuriu și Radames, având ca genitor comun soiul rezistent Villard blanc, și între soiurile Transilvania și Splendid (genitor comun Black rose).*

**Cuvinte cheie:** analiză cluster, analiza în componenți principali, indice de înlănțuire, monitorizare genetică, soiuri autohtone

## INTRODUCTION

Knowing and maintaining biodiversity is essential to ensure the survival of any form of life. At national level, the genetic heritage of vine cultivars is often doubtful, because are missing the relevant data on the identity of cultivars, especially on autochthonous grapevine cultivars. This situation makes the selection work more difficult and makes impossible to establish the scientific criteria for the classification of vine cultivars, their description, recognition and their use in new breeding programs.

In Romania, the lack of current and complete scientific studies on existing genetic background is currently one of the main problems of breeders and producers, leading to insufficient use of valuable genotypes in grapevine breeding experiments or limits their spread within vineyards.

The use of statistical and mathematical methods in the characterization of cultivars and the determination of the degree of similarity between them has returned to the attention in the conditions of developing the multiple possibilities of data processing, obtaining relevant information regarding the belonging of cultivars to different sort groups, the degree of association between cultivars, and their differentiation (Boursiquot and This, 1997; Rotaru and Țardea, 2002). The purpose of this study was to determine the degree of phenotypic similarity between some autochthonous grapevine cultivars, based on the main physico-mechanical, biochemical and physiological characteristics of grapes and leaves, using cluster analysis, which admits the existence of polythetic groups (similar groups of cultivars) and allows verification of the genotype belonging to a varietal group, and the separation of studied cultivars into branches according to the principle of dissimilitude or similarity between them.

## MATERIAL AND METHOD

Research was carried out on 11 grapevine cultivars created in Romania: Someșan, Milcov, Napoca, Cetățuia, Coarnă neagră, Coarnă neagră selecționată, Gelu, Transilvania, Splendid, Purpuriu and Radames, the biological material being sampled from the Ampelographic collection of the University of Agricultural Sciences and Veterinary Medicine, Iasi, Romania (27°53 'E; 47°09' N).

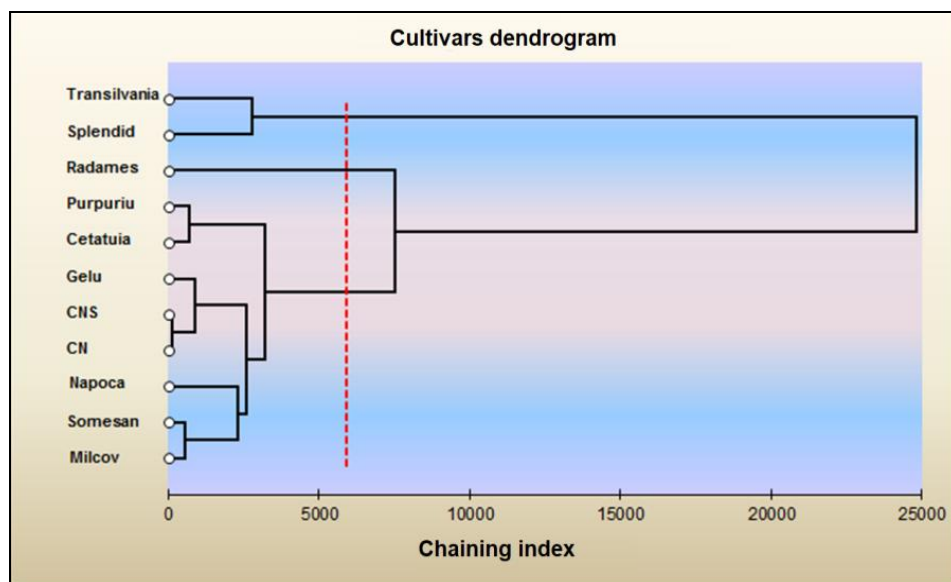
In order to highlight the relationships between the analyzed cultivars, based on the main physical and mechanical (uvological indices, grape weight, 100 berries weight, rachis weight, number of berries on bunches, number and weight of seeds), biochemical (humidity, soluble substance, minerals, ascorbic acid, phenolic

compounds, pH, sugars, acidity, proteins, anthocyanins, peroxidase activity) and physiological (chlorophyll a, chlorophyll b, carotenoids and chlorophyll index) characteristics, were plotted the dendrogram and the histogram of analysed cultivars, on the basis of the generalized Ward criterion, in the XLStat® software, in Microsoft Excel® application. Physico-chemical determinations were performed according to the OIV methodology (OIV, 2012). The results of the experimental determinations were previously published by the authors in the context of the characterization and quality assessment of the studied cultivars (Filimon *et al.*, 2016; Filimon *et al.*, 2017).

## RESULTS AND DISCUSSIONS

From the analysis of the obtained dendrogram was noted the existence of ten major polythetic groups (fig.1). In this ensemble, first cultivars that aggregate, and which have the highest phenotypic similarity, are the Coarnă neagră (CN) and Coarnă neagră selecționată (CNS), which showed the lowest chaining index of 119,12, to which the Gelu cultivar (cv.) was further attached.

The second node was formed by Purpuriu and Cetățuia cultivars (658.61), followed by the chaining of Someșan and Milcov (806.93), which form the third minor node of the dendrogram.



**Fig. 1** Dendrogram of the autochthonous grapevine cultivars analyzed based on the physico-biochemical characteristics

Fourth node was formed by addition of Gelu cv. to first node (Coarnă neagră and Coarnă neagră selecționată). This approach is explained by the fact that the Gelu cv. is obtained from Coarnă neagră cv. (by seed irradiation), showing a large number of common characteristics with the genitor.

Someșan, Milcov and Napoca cv., which have as common genitor Muscat Hamburg cv., formed the fifth node of the chain (2203.68). Transilvania and Splendid cv. (node 8; 4015, 47) are the last that aggregate to the rest of the dendrogram, having as a common genitor the Black rose cv. The final node (tenth node), linking all the analyzed cultivars, showed a high value of the chaining index (24809.97), indicating their high variability and belonging to various sortogroups.

The lower the linking value, the more the cultivars that formed the groups are more phenotypically similar. The values of the chaining index for all nodes are shown in the obtained histogram (fig. 2).

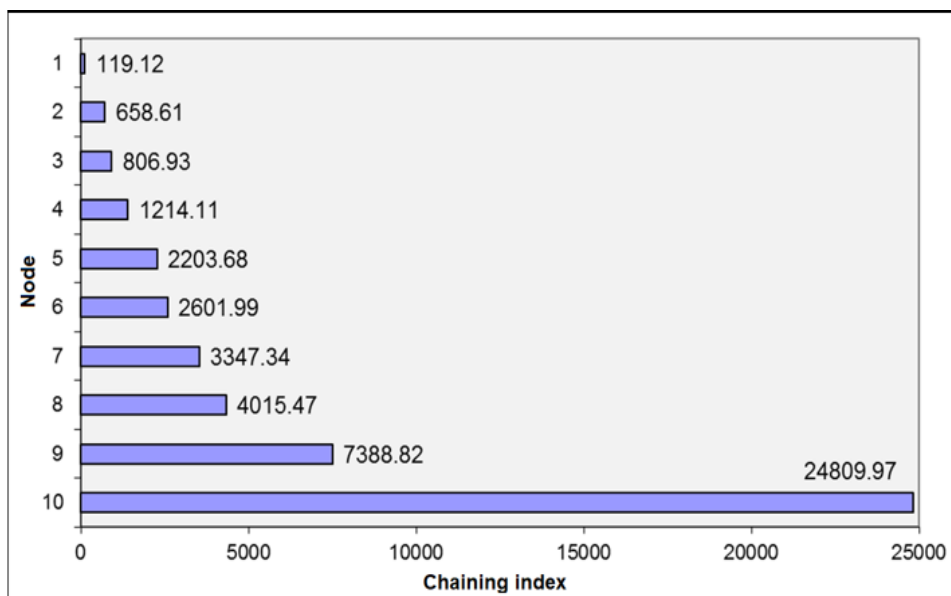


Fig. 2 Hierarchical histogram of autochthonous grapevine cultivars analyzed

In table 1, is presented the level of clustering of the autochthonous cultivars within the dendrogram and the genotypes that formed each node. For the formation of groups, on the basis of individual characteristics, principal component analysis (PCA) was initiated, based on the study of covariance or the correlations between variables, which allows the differentiation and grouping of the cultivars based on leaf and grapes peculiarities (Rotaru and Petrea, 2006). Thus, the main node comprises all 11 cultivars studied, in the order of their phenotypical similarity: Coarnă neagră ~ Coarnă neagră selecționată ~ Gelu ~ Someșan ~ Milcov ~ Napoca ~ Purpuriu ~ Cetățuia ~ Radames ~ Transilvania ~ Splendid.

Principal component analysis (PCA) indicated the presence of four main groups of cultivars.

The level of cultivar clustering in the dendrogram

Nodes composition	Node no.	Number of cultivars in the node	Index value
Coarnă neagră ~ Coarnă neagră selecționată	1	2	119.12
Purpuriu ~ Cetățuia	2	2	658.61
Someșan ~ Milcov	3	2	806.93
Coarnă neagră ~ Coarnă neagră selecționată ~ Gelu	4	3	1214.11
Someșan ~ Milcov ~ Napoca	5	3	2203.68
Coarnă neagră ~ Coarnă neagră selecționată ~ Gelu ~ Someșan ~ Milcov ~ Napoca	6	6	2601.99
Coarnă neagră ~ Coarnă neagră selecționată ~ Gelu ~ Someșan ~ Milcov ~ Napoca ~ Purpuriu ~ Cetățuia	7	8	3347.34
Transilvania ~ Splendid	8	2	4015.47
Coarnă neagră ~ Coarnă neagră selecționată ~ Gelu ~ Someșan ~ Milcov ~ Napoca ~ Purpuriu ~ Cetățuia ~ Radames	9	9	7388.82
Coarnă neagră ~ Coarnă neagră selecționată ~ Gelu ~ Someșan ~ Milcov ~ Napoca ~ Purpuriu ~ Cetățuia ~ Radames ~ Transilvania ~ Splendid	10	11	24809.97

Thus, was highlighted the intersection of the group of cultivars that have as main genitor Coarnă neagră cv. and that of cultivars that have as genitor Muscat de Hamburg cv., as is the case of Milcov cv. (fig.3).

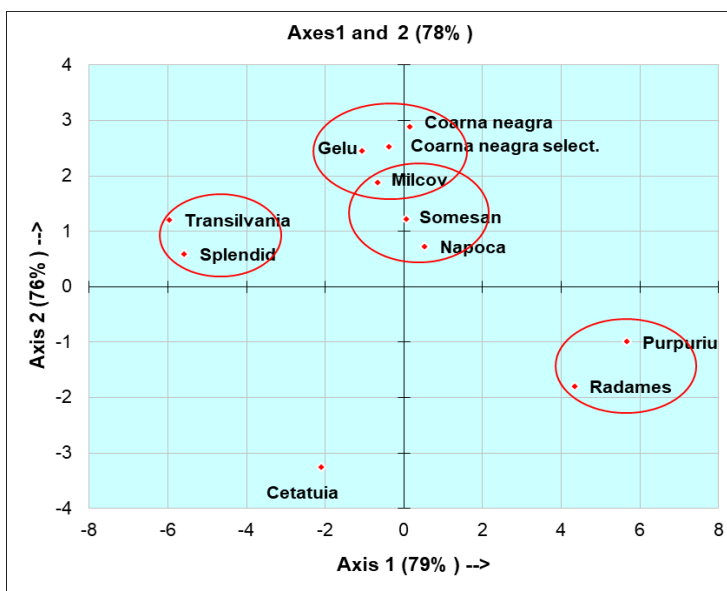


Fig. 3 Polythetic groups formed by principal component analysis

Purpuriu and Radames resistant cultivars, with Villard blanc cv. as common genitor, formed an individual group, as is the case of Transilvania and

Splendid cv. group (common genitor Black Rose). The correlation factors of the two axes were 0.79 (Axis 1) and 0.76 (Axis 2), while the data on the two axes correlated positively with a value of the correlation coefficient of 0.78 (Fig. 3).

## CONCLUSIONS

1. Based on the physico-biochemical characteristics of leaves and grapes, cluster analysis led to the grouping of autochthonous grapevine cultivars studied in four major polythetic groups (similar groups of cultivars), which corresponded to their genealogy.

2. Cultivars that showed the lowest value of the chaining index were Coarnă neagră and Coarnă neagră selecționată, followed by Purpuriu and Cetățuia, and Someșan and Milcov, respectively, which indicates the very high phenotypic similarity between these cultivars within the group, given by their common origin.

3. Milcov cv. was included in the group consisting of the Coarnă neagră~Coarnă neagră selecționată ~ Gelu, also joining to the polythetic group of Someșan ~ Napoca cultivars, position justified by the origin of this cultivar, which has as genitors Coarnă neagră and Muscat de Hamburg cultivars.

4. The study of the physico-biochemical characteristics of grapes, together with the physiological and biometric features of the leaves, may provide relevant information on the degree of similarity between cultivars and on their origin, by means of statistical and mathematical analysis of data.

## REFERENCES

1. **Boursiquot J.M., This P., 1997** – *Les nouvelles techniques utilisées en ampelographie; informatique et marquage*. Journal International des Sciences de la Vigne et du Vin, vol. 40, nr. 1, p. 13-23.
2. **Filimon V.R., Filimon M. Roxana, Nechita Ancuța, Băetu M.M., Rotaru Liliana, Arion Cristina, Patraș Antoanela, 2017**–*Assessment of quality characteristics of new Vitis vinifera L. cultivars for temperate climate vineyards*. Acta Agriculturae Scandinavica, Section B - Soil & Plant Science. vol. 67, nr. 5, p. 405-415.
3. **Filimon V.R., Rotaru Liliana, Filimon Roxana, 2016** –*Quantitative investigation of leaf photosynthetic pigments during annual biological cycle of Vitis vinifera L. table grape cultivars*. South African Journal for Enology and Viticulture, vol. 37, p. 1-14.
4. **Rotaru Liliana, Țârdea C., 2002** – *Folosirea analizei cluster în ampelografie pentru stabilirea asemănărilor fenotipice la soiurile de viță de vie*. Lucrări Științifice USAMV Iași, seria Horticultură, vol.45, nr.1, p. 189-193.
5. **Rotaru Liliana, 2004** – *Aplicarea analizei cluster în caracterizarea vițelor portaltoi din grupa Berlandieri x Riparia*. Lucrări Științifice USAMV Iași, seria Horticultură, vol. 47, nr.1, p. 751-754.
6. **Rotaru Liliana, Petrea Gabriela, 2006** – *The Cluster analysis of clones obtained from Aliote grapevine variety*. Rev. Cercetări Agronomice în Moldova, Iași, vol.126 (2)/2006, p. 31-34.
7. **\*\*\* OIV, 2012** - *Compendium of international methods of wine and must analysis*. Vol. II. Organisation Internationale de la Vigne et du Vin, Paris.

## STUDIES ON THE INFLUENCE OF THE LOAD CHARGED ON THE TECHNOLOGICAL POTENTIAL OF RED CULTIVATED VINEYARDS IN THE WINE CENTER OF IAȘI COPOU

### STUDII PRIVIND INFLUENȚA ÎNCĂRCĂTURII DE ROD ATRIBUITĂ LA TĂIERE ASUPRA POTENȚIALULUI TEHNOLOGIC AL SOIURILOR ROȘII DE VIȚĂ DE VIE CULTIVATE ÎN CENTRUL VITICOL COPOU IAȘI

*NECHITA Ancuța*<sup>1\*</sup>, *ZALDEA Gabi*<sup>1</sup>, *ALEXANDRU C*<sup>1</sup>,  
*FILIMON R.*<sup>1</sup>, *FILIMON Roxana*<sup>1</sup>, *DAMIAN Doina*<sup>1</sup>

\*Corresponding author e-mail: ancuta.vasile@yahoo.com

**Abstract.** *The quantity and quality of the grape production depends on the biological potential of the varieties, the favorability of climatic conditions and the eye loads left to be cut. Achieving quality production with healthy grapes, high sugar concentrations and high phenolic content is a priority for viticulturists. In order to determine the influence of the fruit load attributed to cutting on the technological potential of the red varieties cultivated in the Copou Iași vineyard, the varieties Arcaș and Cabernet Sauvignon were studied. Three loads were tested: 20 eyes / bud (T1), 36 eyes / bud (T2) and 28 eyes / bud (M). The T1 variant was highlighted with reduced eye load, which positively influenced the size of the grapes, the accumulations of sugars and the phenolic compound content.*

**Key words:** fruit loads, technological indexes, phenolic potential

**Rezumat.** *Cantitatea și calitatea producției de struguri depinde de potențialul biologic al soiurilor, favorabilitatea condițiilor climatice și de sarcinile de ochi lăsate la tăiere. Realizarea unor producții de calitate, cu struguri sănătoși, concentrații mari de zaharuri și conținut fenolic ridicat constituie o prioritate pentru viticultori. Pentru a determina influența sarcinii de rod atribuită la tăiere asupra potențialului tehnologic al soiurilor roșii de viță de vie cultivate în centrul viticol Copou Iași au fost luate în studiu soiurile: Arcaș și Cabernet Sauvignon. Au fost experimentate trei încărcături: 20 ochi /butuc (T1), 36 ochi /butuc (T2) și 28 ochi /butuc (M). S-a remarcat varianta T1, încărcătură redusă de ochi, ce a influențat pozitiv mărimea strugurilor, acumulările de zaharuri și conținutul de compuși fenolici.*

**Cuvinte cheie:** încărcături de rod, indici tehnologici, potențial fenolic

## INTRODUCTION

The qualitative potential of vine varieties differs according to the area in which they are grown, being heavily influenced by the culture technology used and climatic conditions (Pomohaci *et al.*, 2000). The achievement of constant and high quality wine production is determined by the correct application of the agrofitotechnical complex. Among the agrofitotechnical works that can lead to the

<sup>1</sup>Viticulture and Oenology Research and Development Station in Iasi, Romania



increase of the technological potential of the grapes in the red varieties we mention the yielding cuttings by attributing optimal loads to the biological potential of the variety. Excessive fruit loads cause the imbalance between grape production and vegetative development, the star of a small number of eyes in the vegetation, the decrease of fertility and productivity of horns, the occurrence of discontinuities in the pruning of shoots (Poenaru *et al.*, 1976, Mihalca *et al.*, 1986, Murisier *et al.*, 2005). The reduction of the fruit load is accompanied by a quantitative decrease in production and an increase in quality, different depending on the variety (Pițuc *et al.*, 1992; Țârdea *et al.*, 1992). At the same time, the load attributed to the cutting cannot be much different from the one that optimally exploits the growth vigor (Payan *et al.*, 1991; Irimia and Țârdea., 2004).

In order to determine the influence of the fruit load attributed to cutting on the technological potential of the red varieties cultivated in the Wine Center of Copou Iași, two varieties have been studied for two years (2016 and 2017): Arcaș, variety obtained at SCDVV Iași and Cabernet Sauvignon from the international cultivar.

## MATERIAL AND METHOD

The experimental lots were located in a vineyard plantation established in 2009 on a planted plain with south exposure, chernozem cambic soil with planting distances of 2.2 m between rows and 1.2 m per row, with a strain height of 0.8 m. The field experience was assembled on 6 rows (3 rows / variety) in 3 variants including the control variant, placed in 3 rehearsals. Each variant contained 21 hubs with three loads: 20 eyes / hump (T1); 36 eyes / horn (T2) and 28 eyes / hump (M).

Grape quality was assessed on the basis of physico-chemical analyzes focusing mainly on sugars (g / L), acidity (g / L H<sub>2</sub>SO<sub>4</sub>) and weight of 100 grains (g). The analysis of the mechanical composition of the grapes was performed for the calculation of the technological indices which characterize the quality of the grapes, as well as the technological yields that can be obtained. Thus, at the date of grapes harvesting, the following parameters were determined for each variety: grape weight (g), grape volume (mL), grain number and grain weight (g).

For the evaluation of phenolic compounds in grapes was determined by standard Glories method: the total polyphenolic potential (ApH1 - mg/L), the extractable anthocyanins potential (ApH3,2 - mg/L), the percentage of anthocyanins extractability (AE - %), total polyphenols index (mg/L), the content of tannins in seeds and skins (mg/L) and the maturity of the seeds (MS).

## RESULTS AND DISCUSSIONS

The climatic conditions of the study period (2016-2017) were characterized by: annual average temperatures higher than the multiannual value (9.8°C), namely from 10.8°C in 2017 and 11.0°C in 2016; absolute minimum temperatures below the freezing limit of the vine, between -18,7°C and - 21,0°C; high number of days with maximum temperatures above 30°C (39 days in 2017 and 53 days in 2016); warm summers with absolute maximum temperatures ranging from 34.9°C (2016) to 37.3°C (2017); low rainfall and unevenly distributed during the

vegetation period, respectively 333.8 mm in 2016 and 293.4 mm in 2017 versus 398.1 mm, normal value in The Wine Center of Copou - Iași.

The quality of the grape production of the Cabernet Sauvignon and Arcaș varieties was influenced by the climatic factors which in 2016 were more favorable to the accumulation of sugars (tab. 1).

Table 1

Grape quality at harvest in the climatic conditions of the years 2016 -2017

Variety	Variant	Sugars, g/L		Acidity, g/L H <sub>2</sub> SO <sub>4</sub>		Weight 100 grains, g	
		2016	2017	2016	2017	2016	2017
Cabernet Sauvignon	M=28 eyes	195	182	4.3	4.8	115	123
	T1=20 eyes	204	184	4.2	4.7	118	129
	T2=36 eyes	191	179	4.5	4.9	113	124
Arcaș	M=28 eyes	209	181	3.7	4.3	114	127
	T1=20 eyes	211	185	3.3	4.3	120	132
	T2=36 eyes	185	180	4.2	4.4	115	125

During the two years of study, the varieties have accumulated more than 180 g/L sugars in the wort, highlighting the Arcaș variety. In both varieties, the fruit load exerted a significant influence on the accumulation of sugars and the decrease in acidity. Amplification of the fruit load led to a decrease in the concentration of must in sugars, the highest values being T1 (20 eyes / hub) and the lowest in the T2 (36 eyes / hub). Also, the acidity values have decreased with the reduction in fruit load. The weight of 100 grains recorded lower values in 2016 and higher in 2017, and according to the fruit load, both varieties have recorded higher at T1 variant (20 eyes / hub).

After analyzing the mechanical composition of the grapes (tab. 2) it was visible the fact that at the moment of complete maturation, which concluded with the harvest, the medium weight of a grape was different with the type, between 128 and 209 g for Arcaș, 132 and 177 g for Cabernet Sauvignon.

Table 2

Mechanical analysis of the grape at harvest

Variety	Variant	Weith of a grape (g)		Volume of grape (mL)		No. grains		Bunch weight (g)	
		2016	2017	2016	2017	2016	2017	2016	2017
Cabernet Sauvignon	M=28 ochi	138	177	130	168	117	152	6.17	9.17
	T1=20 ochi	150	132	143	127	132	116	6.17	5.17
	T2=36 ochi	133	152	123	143	125	133	6.67	6.67
Arcaș	M=28 ochi	149	155	140	150	148	131	8.17	6.67
	T1=20 ochi	128	175	120	170	119	143	6.67	7.17
	T2=36 ochi	131	209	125	199	116	154	6.00	9.00

The technological characteristics of the grapes were evaluated according to index composition of the grape, berry index, berry composition, berry structure, grape must yield and yield index (tab. 3 and tab. 4).

Table 3

Technological indices of the grapes at harvest in 2016								
Variety/ Variant	Index composition of grape	Index graines	Index composition of grain	Grain structure			Grape must yield (%)	Yield index
				% skins	% seeds	% pulp		
<b>Cabernet Sauvignon</b>								
M	21.4	84.7	2.6	21.6	5.9	72.5	77.7	3.5
T1	23.3	88.2	2.8	20.4	5.9	73.8	76.6	3.3
T2	18.9	94.6	2.5	22.4	6.1	71.5	77.5	3.4
<b>Arcas</b>								
M	17.2	99.8	2.4	19.0	10.3	70.7	76.6	3.3
T1	18.2	93.0	2.4	20.1	9.5	70.6	79.5	3.9
T2	20.8	99.2	2.9	17.0	8.8	74.2	79.4	3.8

Table 4

Technological indices of the grapes at harvest in 2017								
Variety/ Variant	Index composition of grape	Index graines	Index composition of grain	Grain structure			Grape must yield (%)	Yield index
				% skins	% seeds	% pulp		
<b>Cabernet Sauvignon</b>								
M	18.8	85.7	3.9	15.6	4.9	79.5	79.5	3.0
T1	25.4	87.9	2.9	20.6	4.8	74.6	74.6	4.0
T2	29.3	89.7	3.4	18.2	4.5	77.4	77.4	3.7
<b>Arcas</b>								
M	27.2	86.1	4.5	12.5	5.7	81.8	79.7	3.9
T1	22.9	82.1	4.9	8.8	7.8	83.4	79.3	3.8
T2	22.7	73.7	3.9	14.1	6.3	79.6	79.1	3.8

The grape composition index had values ranging from 17.2 to 27.2 in Arcas, respectively from 18.8 to 29.3 in Cabernet Sauvignon, which allows us to say that the grapes were well established in all three variants, there is no correlation with the fruit load attributed to the cutting.

Grain index values were close to the maximum limit in 2016, and between 93.0 and 99.8 for the Arcas variety and between 84.7 and 94.6 for Cabernet Sauvignon. In 2017, due to less favorable climatic conditions, the values were lower, between 73.7 and 89.7.

The bean composition index had small values (2.4 - 4.9) below the 5th limit, indicating a higher proportion of skins and seeds than normal, due to rainfall and water scarcity accessible from the soil near the level of wilting coefficient during the vegetation period.

The values of the parameters that characterize the structure of the grain were higher in the skins ranging between 17.0% and 22.4% in the year 2016 and lower in 2017, respectively between 8.8 and 20.6%. In the case of seeds, the values are above the maximum limit of 5%. As for the amount of pulp, the percentages are below the 73% minimum for both varieties in 2016, which are affected by drought and over 79% in 2017, which resulted in a wort yield of 74.6

and 79.7%.

Anthocyanic potential varies primarily according to variety, grape maturation and climatic conditions of the viticultural area (tab. 5 and tab. 6). Thus, at harvest, the anthocyanin content (ApH1) reached values between 1103.48 mg / L and 1597.0 mg/L in 2016, namely values between 994.52 mg/L and 1340.0 mg/L in 2017.

Table 5

**Phenolic potential of Cabernet Sauvignon grapes**

Parameters determined	M=28 ochi		T1=20 ochi		T2=36 ochi	
	2016	2017	2016	2017	2016	2017
ApH1 (mg/L)	1145.36	994.52	1125.2	980.79	1103.48	985.52
ApH3,2 (mg/L)	304.2	164.51	298	164.51	293.32	142.78
AE (%)	73.44	83.46	73.52	83.23	73.42	85.51
Total polyphenols (mg/L)	17.8	11.0	18.2	10,0	18.2	10.4
Skin tannins (mg/L)	12.16	6.58	11.92	6.58	11.72	5.71
Seed tanins (mg/L)	59.04	37.42	60.88	33.42	61.08	35.89
Seeds at maturity (%)	82.9	85.04	83.6	83.55	83.9	86.27

Table 6

**Phenolic potential of Arcaș grapes**

Parameters determined	M=28 ochi		T1=20 ochi		T2=36 ochi	
	2016	2017	2016	2017	2016	2017
ApH1 (mg/L)	1576.84	1323.36	1597.0	1340.0	1559.76	1324.49
ApH3,2 (mg/L)	420.6	335.23	406.64	338.34	400.4	315.06
AE (%)	73.33	74.67	74.54	74.75	74.33	76.21
Total polyphenols (mg/L)	21.6	12,0	22.2	12.6	22.4	10.8
Skin tannins (mg/L)	16.84	13.41	16.28	13.53	16.0	12.6
Seed tanins (mg/L)	69.56	34.59	72.52	36.87	73.6	30.6
Seeds at maturity (%)	80.5	72.06	81.7	73.15	82.1	70.83

The Arcaș variety has a higher anthocyanin potential compared to Cabernet Sauvignon, the two varieties are being characterized as having good (800-1000) and excellent (> 1200) anthocyanic potential. The different fruit loads attributed to the cutting had a small influence on the anthocyanic potential of the grapes, higher values being recorded in the T1 variant (20 eyes). Extractability of anthocyanins from grape grains (EA%) showed close values for the two varieties, the results confirming that anthocyanin extractability is a characteristic of the variety. The studied varieties presented in 2017, a reduced content of anthocyanins and total polyphenols, compared to the previous year, due to climatic conditions less favorable to phenolic maturation. They contain enough quantities of polyphenols in the grain so with adequate technology provide a good colour of the wine.

The largest quantities of tannin have been identified in seeds, confirmed by specialty literature (Țârdea, 2010). In tannins, the tannin content is much lower, especially in the Arcaș variety with values between 16.0 and 16.84 mg / L (2016), respectively between 12.60 and 13.53 mg / L (2017).

Regarding the phenolic seed maturation (MP), the analysis of the obtained

results highlights the decisive role of the genetic factor, the highest values being recorded in the Cabernet Sauvignon variety (82.90 – 86.27%).

## CONCLUSIONS

1. During the two years of study, the technological potential of the Arcaș and Cabernet Sauvignon varieties was influenced both by the climatic factors and by the fruit loads attributed to the cutting.

2. Sugar accumulations were superior to T1 variant (20 eyes/hub) and lower to T2 variant (36 eyes/hump), and the total acidity values of the wort were reduced compared to previous years, aspect due to the increased pedological drought and high temperatures. Also, the 20 eye/hub loads have positively influenced the accumulation of phenolic compounds in grapes.

3. The studied varieties contain sufficient amounts of polyphenols in the grain skin to ensure with the use of adequate technology the proper colour of the wines. As highlighted, the Arcaș variety has a qualitative technological potential superior to the genitor variety Cabernet Sauvignon.

*Acknowledgments: The work was developed under the Sectorial Plan the ADER 2020, PS 3.3.10 "Research on identifying and defining the typical elements of Romanian wines. Valorisation sanogenic potential of wines by increasing the phenolic content"*

## REFERENCES

1. Irimia L., Țârdea C., 2004 – *Cercetări privind influența sarcinei de rod asupra producției de struguri și a calității acestora la soiurile de viță de vie pentru struguri de vin cultivate în centrul viticol Averești-Huși*. Lucr. Științifice, vol. 1 (47), USAMV Iași
2. Mihalca Haretia, Vladu Cr., 1986 – *Raționalizarea tăierilor în uscat la soiurile de struguri pentru vin cu conducere pe cordoane, prin aplicarea tăierii în cepi roditori*. Analele I.C.V.V., vol XI, pp. 157-174.
3. Murisier F., Ferretti M., Zufferey V., 2005 - *Essai de conduite et de taille sur Merlot au Tessin*. Revue Suisse Vitic., Arboric., Hortic., vol. 37 (4), pag. 209
4. Payan J.J., Sanchez G., Vendran H., 1991 - *Recherche d'un équilibre rendement-qualité par la charge à la taille sur Gamay, Grenache et Syrah*. Riv. Vitic. Enol., no 4, pp: 309-312
5. Pițuc P., Pițuc Larisa, 1989 - *Stabilirea nivelului optim al încărcăturii de rod atribuită prin tăierea în uscat la soiurile de viță de vie condusă pe tulpini cu cordoane bilaterale*. Anale ICVV, vol. XII, pp: 115 - 132.
6. Poenaru I., Popa Val., Budan C., Bobeleac Maria, Barbu I., 1976 – *Influența încărcăturii de rod la diferite forme de conducere asupra producției unor soiuri de struguri pentru masă*. Analele I.C.V.V., vol. VII, pp: 239 - 258.
7. Pomohaci N., Stoian V., Gheorghită M., Sirghi C., Cotea V.V., Nămoșanu I., 2000 – *Oenologie, vol I. Prelucrarea strugurilor și producerea vinurilor*, Ed. Ceres, București, pag. 77-105.
8. Țârdea C., Țârdea Angela, Iuroaie T., 1992 – *Tăierea cu elemente scurte de rod la soiurile de viță de vie din podgoria Cotnari*. Lucr. Științifice, vol. 34, seria Hortic., Univ. Agronomică "Ion Ionescu de la Brad" Iași, p.52.
9. Țârdea C., 2010 – *Tratat de vinificație*. Editura "Ion Ionescu de la Brad", Iași.

## REMUS - NEW VARIETY OF VINE FOR ROSE AND RED WINES WITH HIGH BIOLOGICAL RESISTANCE

### REMUS - SOI NOU PENTRU OBTINEREA VINURILOR ROSE ȘI ROȘII CU REZISTENȚĂ BIOLOGICĂ RIDICATĂ

PUȘCALĂU Marioara<sup>1</sup>\*, BOSOI Ionica<sup>1</sup>, MIHU G.<sup>1</sup>

\*Corresponding author e-mail: mioara\_bosoi@yahoo.com

**Abstract.** *The scientific research in the field of vine improvement, with a permanent role in the diversification the assortments of vine, is oriented both to the creation of new qualitative and productive genotypes, but also to the obtaining of genotypes with increased resistance to diseases and tolerance to stress factors. In order to respond to this goal, at R.D.S.V.O. Odobești, through the hybridization directed between the intraspecific hybrid (Băbească neagră x Fetească neagră) and the interspecific hybrid Couderc 14 (Vitis lincecumii x Aramon) has been obtained and homologated in 2016 the assortment called Remus. The new creation is characterized by small to medium sized grapes (167 g), small berry (1.9 g), with crisp core and dark red-purple coloured skin, the pulp is firm, semi-soft, very slightly colored. The average grape production is 4.0 kg/vin, respectively 15.5 tons/ha. It presents high biological resistance to major cryptogamic diseases. The grapes reach maturity in the epoch V. Are obtained the rose or red wines for current consumption or high quality, with an average alcoholic potential (11.5 – 12.0% alcohol by volume), relatively low acidity (5.8 - 6.8 g/L tartaric acid), and mean values of the non-reducing extract (17.9 - 19.5 g/L).*

**Key words:** variety, interspecific hybrid, biological resistance

**Rezumat.** *Cercetarea științifică din domeniul ameliorării viței de vie cu rol permanent în diversificarea sortimentului viticol, este orientată atât pentru crearea de genotipuri noi valoroase calitativ și productiv, dar și pentru obținerea de genotipuri cu rezistență sporită la boli și toleranță la factorii de stres. Pentru a răspunde acestui deziderat, la S.C.D.V.V. Odobești prin lucrări de hibridare sexuată între hibridul intraspecific (Băbească neagră x Fetească neagră) și hibridul interspecific Couderc 14 (Vitis lincecumii x Aramon) a fost obținut și omologat în anul 2016 soiul Remus. Noua creație se caracterizează prin struguri de mărime mică spre mijlocie (167 g), boabe mici (1,9 g), cu pielea groasă, de culoare roșu - violet închis, iar pulpa este fermă, semisuculentă, foarte slab colorată. Producția medie de struguri este de 4,0 kg/butuc, respectiv 15,5 tone/ha. Prezintă rezistență biologică mare la principalele bolile criptogamice. Strugurii ajung la maturitate în epoca a V-a. Se obțin vinuri rose sau roșii de consum curent sau superioroare, cu un potențial alcoolic mediu (11,5 – 12,0% vol alcool), aciditate relativ scăzută (5,8 - 6,8 g/L acid tartric) și valori medii ale extractului sec nereducător (17,9 - 19,5 g/L).*

**Cuvinte cheie:** soi, hibrid interspecific, rezistență biologică

<sup>1</sup> Research and Development Station for Viticulture and Oenology Odobești, Romania

## INTRODUCTION

The varietal range of the vine varieties admitted for cultivation in recreational plantations in households is rather limited and needs to be supplemented and diversified with new genotypes. The researches carried out over the last four decades in our country have led to the obtaining of genotypes of valuable vines with high tolerance to diseases resistant to drought and frost (Calistru and Damian, 1999; Culcea *et al.*, 2004; Damian *et al.*, 2012). New wine grape varieties with biological resistance to cryptogamic diseases and frost, by their qualities resembling "noble vine", sustained by a high production potential and superior sugar storage capacity, are a solution to counteract the growing spread and uncontrolled direct hybrid producers in some areas of Romania.

The use of valuable hybrid combinations with genetic resistances obtained over time in the field of vine cultivation has led to the obtaining and approval of a new Remus variety that complements the varietal conveyer of varieties of biologically enhanced disease resistance and low temperatures, adapted to the specific conditions of vineyards in south - east of Moldova.

## MATERIAL AND METHOD

The study was carried out between 2014 - 2015, on a plantation aged 35 years, planting on soil type cernoziom levigated, located in the biological field SCDVV Odobești. For comparison, as a witness was used Băbească neagră variety, that is found in the hybrid combination that represents the parents maternal and is similar to the production direction. The varieties Remus and Băbească neagră was grafted on Kobber 5 BB rootstock, the training system with trunk of hub to the ground, with Dr. Guyot cutting system. Fruit load was 44 eye/vine, distributed on the canes with 9 eye and the spur with 2 eye. Distance of planting by 2.2 m x 1.2 m is returning 3788 but/ha. Were studied the ampelographic main characters, were made measurements and determinations on elements of fertility and productivity, the amount and quality of grape production, disease resistance, physico-chemical characteristics of the wine.

The main climatic conditions of during the study period and multiannual values are presented in table 1. The research period was characterized by heliothermal availability close to normal in 2014 and very high (2549.0 hours) in 2015 compared to the multi-annual value (2137.2 hours). The average annual air temperatures recorded during the two years of study (12.1°C and 13.1°C) were above the multi-annual average (10.7°C). The pluviometric regime was surplus in 2014 (903.3 mm) and close to normal in 2015 (650.6 mm), with uneven distribution over the vegetation period, with a surplus of 153.8 mm in 2014 and a deficit of 29.4 mm in 2015. The sum of the useful temperature ranges during the vegetation period (1885.7°C, respectively 2035.0°C) was well above the multiannual value (1590.8°C).

The main ampelographic characters were studied, the fertility and productivity determinations, the behavior at cryptogamic diseases and frost, the grape production quantity and quality, the physico-chemical characteristics of the wine.

The main climatic conditions of study period (Odobești, 2014-2015)

Climatic Indicator	Multiannual (1946 -2013)	Year		Average 2014 - 2015
		2014	2015	
Annual				
The average temp., °C	10.6	12.1	13.1	12.6
Temp max. abs., °C	39.4	35.6	37.4	36.5
Temp min. abs., °C	-22.8	-16.6	-17.4	-17.0
Amount degrees usful temp.( $\Sigma^{\circ}\text{tu}$ ), °C	1613.6	1932.2	2085.3	2008.8
The amount heatstroke, hours	2137.2	2132.3	2549.0	2340.7
Precipitation amount, mm	610.8	903.3	650.6	777.0
On the vegetation period				
The average temp., °C	17.0	18.5	19.2	18.9
Temp max. abs., °C	39.4	35.6	37.4	36.5
Temp min. abs., °C	-8.2	0.1	1.6	0.9
Amount degrees usful temp.( $\Sigma^{\circ}\text{tu}$ ), °C	1590.8	1885.7	2035.0	1960.4
The amount heatstroke, hours	1645.2	1694.6	1880.8	1787.7
Precipitation amount, mm	427.6	581.4	398.2	489.8

## RESULTS AND DISCUSSIONS

The ampelographic characters of the Remus variety (fig. 1 and fig. 2) are shown in table 2.



Fig. 1 Young shoot



Fig. 2 Remus variety (adult leaf, grape, berry)

In the climatic conditions presented, the Remus variety has started in vegetation (disbudding phase) between 20<sup>th</sup> – 26<sup>th</sup> of April, the flowering phase was between 25<sup>th</sup> - 29<sup>th</sup> of May and the veraison was recorded between 4<sup>th</sup> - 8<sup>th</sup> of August. The grapes reached full maturity between 12<sup>th</sup> - 24<sup>th</sup> of September, approximately 3-4 days earlier than the control variety (tab. 3).



Table 2

**The ampelographic description of the vine variety Remus**  
(according OIV descriptors list for grape varieties and *Vitis* species, 2<sup>nd</sup> edition -2009)

The character (OIV code)	Remus variety
Young shoot: opening of the shoot tip (OIV 001)	half open
Young shoot: Intensity of anthocyanin coloration (OIV 003)	none or very low
Young shoot: density of prostrate hairs on the shoot tip (OIV 004)	none or very low
Young leaf: color of upper side of blade (OIV 051)	copper- reddish
Adult shoot: attitude -before tying (OIV 006)	semi-erect
Adult shoot: color of the dorsal side of internodes (OIV 007)	green with red
Adult shoot: color of the dorsal side of internodes (OIV 008)	green with red
Adult shoot: length of tendrils (OIV 017)	medium
Mature leaf: size of blade (OIV 065)	small
Mature leaf: shape of blade (OIV 067)	pentagonal
Mature leaf: number of lobes (OIV 068)	five
Mature leaf: shape of teeth (OIV 076)	both sides convex
Mature leaf: degree of opening / overlapping of petiole sinus (OIV 079)	open
Mature leaf: depth of upper lateral sinuses (OIV 094)	deep
Mature leaf: density of erect hairs between main veins on lower side of blade (OIV 085)	none or very low
Mature leaf: density of erect hairs on main veins on lower side of blade (OIV 087)	none or very low
Mature leaf: length of petiole compared to length of middle vein (OIV 093)	slightly shorter
Bunch: length - peduncle excluded (OIV 202)	medium
Bunch: density (OIV 204)	medium
Bunch: length of peduncle of primary bunch (OIV 206)	medium
Berry: length (OIV 220)	short
Berry: width (OIV221)	narrow
Berry: shape (OIV 223)	globose
Berry: color of skin (OIV 225)	dark red violet
Berry: thickness of skin (OIV 228)	thick
Berry: intensity of flesh anthocyanin coloration (OIV 231)	none or very low
Berry: firmness of flesh (OIV 235)	Slightly firm

Table 3

**Phenological spectrum in the conditions of Odobești vineyard**

Variety	Disbudding	Flowering	Veraison	Physiological maturity
Remus	20 - 26.04	25 - 29.05	04 - 08.08	15 - 20.09
Băbească neagră (Mt.)	18 - 24.04	23 - 27.05	05 - 08.08	19 - 23.09

Under the conditions of the Odobești vineyard, the variety has small to medium growth, and the grapes are matured in the second half of September - epoch V –a (tab. 4).

Table 4

**The main agrobiological characteristics of Remus variety**

Elements studied	Remus	Băbească neagră (Mt.)
Length of vegetation period (days)	180 -190	182 - 194
The maturing period (at Odobesti)	V	V
The vigor of the vine stock - through the bonitation	small to medium	medium

The main fertility and productivity elements, as well as the resistance to frost of new Remus variety, are presented in table 5.

Table 5

**Fertility/productivity elements, and the resistance to frost (average data 2014 - 2015)**

Variety	Dead buds (%)	Fertile shoots (%)	Fertility coefficients		Productivity indices	
			Relative	Absolute	Relative	Absolute
Remus	3.5	70.9	1.11	1.56	185	260
Băbească neagră (Mt.)	7.0	69.6	0.96	1.33	192	266

Remus variety showed a fertility potential higher than the variety control (70.9%, and 69.6%) and higher fertility coefficients (Cfa - 1.46 for the Remus variety and 1.33 for the Băbească neagră variety ). Instead, productivity indices have lower values for the new variety (Ipa - 260; Ipr - 185). Resistance to wintering of Remus variety under unprotected crop conditions in the 2014 - 2015 climate was very good (3.5% dead bud).

Compared to control variety - Băbească neagră, in the climatic conditions of the years 2014 - 2015, the Remus variety manifested high resistance to the main cryptogamic diseases (tab. 6).

Table 6

**The behavior at the main diseases of the vine**

(according OIV descriptor list for grape varieties and *Vitis* species, 2<sup>nd</sup> edition – 2009)

Variety	Downy mildew ( <i>Plasmopara viticola</i> )		Powdery mildew ( <i>Uncinula necator</i> )		Black rot ( <i>Botrytis cinerea</i> )	
	Leaf	Grape	Leaf	Grape	Leaf	Grape
	OIV 452	OIV 453	OIV 455	OIV 456	OIV 458	OIV 459
Remus	9	9	9	9	9	7 - 9
Băbească neagră (Mt.)	5 - 7	5	5	5	7	5

Studying the technological characteristics of grape production was completed knowledge elements for the new grape variety (tab. 7).

Table 7

**The quantity and quality of grape production (average data 2014 - 2015)**

Variety	No. bunch/vine	Weight grapes (g)	Weight 100 berry (g)	Production grape		Sugars g/L	Total acidity g/L H <sub>2</sub> SO <sub>4</sub>
				Kg/vine	t/ha		
Remus	23.9	167.0	171.0	4.0	15.5	193.0	3.4
Băbească neagră (Mt.)	22.5	200.0	180.0	4.5	17.4	215.0	4.4

Although the number of bunch on the vine is higher for the Remus variety, the lower average weight of the grape has led to a lower production (4.0 kg/vine and 15.5 t/ha) compared to the control variety – Băbească neagră (4.5 kg/vine, respectively 18.6 t/ha). Regarding the quality of the grape production, the content of sugars in the must of the Remus variety was 193.0 g/L and the total acidity was 3.4 g/L H<sub>2</sub>SO<sub>4</sub>.

The main features of wines produced are presented in table 8. The wine obtained from the Remus variety had an alcoholic strength of 11.99% vol. with a total acidity of 6.85 g/L tartaric acid, a non-reducing extract of 18.34 g/L and a residual sugar content of 1.39 g/L.

Table 8

**The physico-chemical characteristics of wines** (average data 2014 – 2015)

Soiul	Alcohol vol. %	Total acidity g/L tartaric acid	Dry extract unreducible g/l	Residual sugar g/L
Remus	11.99	6.85	18.34	1.39
Băbească neagră (Mt.)	13.49	8.12	19.90	1.41

The qualitative characteristics of the wines obtained were below those of the control variety, but in the favorable climatic years they are approaching the characteristics of a high quality wine. Being a vine variety with high biological resistance to cryptogamic diseases, requires a few treatments, especially in years with climatic conditions favorable to the development of pathogens.

## CONCLUSION

1. Remus variety originates from the sexual crossing between the hybrid combination (Băbească neagră x Fetească neagră) and interspecific hybrid Couderc 14 (*Vitis lincecumii* x Aramon).

2. There are obtained rose-to-red wines of current consumption, and in the years favorable even wines of high quality, with medium alcoholic potential (11.5 - 12.0% vol. alc.), relatively low acidity (5.8 – 6.8 g/l tartaric acid), and average values of the non-reducing extract (17.9 - 19.5 g/l).

3. Due to its qualities resembling "noble vine", the genetic resistance to diseases and high tolerance to frost, Remus variety completes the variety of wine varieties and is a solution to counteract the spread of direct producers hybrids in Romania.

## REFERENCES

1. Calistru Gh., Damian Doina, 1999 – *Golia, soi nou de viță de vie cu rezistență sporită la ger*. Lucr. st. seria Horticultura, vol nr. 42, USAMV Iași.
2. Culcea Valeria, Preda Daniela, Marian I., 2004 – *Rosina, soi rezistent pentru vinuri albe*. Analele ICDVV, vol. XVII, București, p.61-65.
3. Damian Doina, Calistru Gh., Nechita Ancuța, Savin C., 2017 – *Mara, soi nou de viță de vie de struguri pentru masă, cu rezistență genetică sporită, creat la S.C.D.V.V. Iași*. Lucr. st. seria Horticultura, vol nr. 55/1, p. 315-320, USAMV Iași.
4. \*\*\*, 2009 – The 2<sup>nd</sup> edition of the OIV Descriptor list for grape varieties and *Vitis* species.

**THE AGROBIOLOGICAL AND TECHNOLOGICAL VALUE  
OF ANCIENT ROMANIAN GRAPE VARIETIES  
(*Vitis vinifera* L.) CULTIVATED IN IAȘI VINEYARD**

**VALOAREA AGROBIOLOGICĂ ȘI TEHNOLOGICĂ A UNOR SOIURI  
VECHI ROMÂNEȘTI DE VIȚĂ DE VIE  
(*Vitis vinifera* L.) CULTIVATE ÎN PODGORIA IAȘI**

**ROTARU Liliana<sup>1\*</sup>, COLIBABA Lucia Cintia<sup>1</sup>, AELENEI S.I.<sup>1</sup>**

\*Corresponding author e-mail: lirotaru@uaiasi.ro

**Abstract.** Global warming, as an extreme climatic phenomenon, shows a strong influence on vine cultivation, leading to the reconsideration of the cultivated grape varieties. The extreme heat during grapes' maturation results in a unbalanced qualitative profile (too high sugar concentration and too low acidity concentration), losing on the way some of the wines specific for certain regions. In this article, ancient Romanian grape varieties were studied, that have been neglected in recent years and that can be reconsidered for the current conditions. The following varieties were studied: Ardeleanca, Braghina, Cruciuliță, Cionic, cultivated in the ampelographic collection of USAMV Iași. These varieties in the past were part of the old varieties of the Romanian vineyards, being cultivated before the phylloxera invasion and bringing the note of originality specific to each vineyard. Many of them have a meritorious behavior, and can be highlighted in the new zoning works of Romanian vines.

**Key words:** ancient Romanian grape varieties, global warming, new zoning from vineyards

**Rezumat.** Încălzirea globală, ca fenomen climatic extrem se face resimțită și asupra cultivării viței de vie, ceea ce duce la reconsiderarea sortimentelor de soiuri cultivate. Astfel căldura extremă din timpul maturării strugurilor face ca aceștia să fie la maturarea deplină cu aciditatea totală a mustului diminuată, concentrațiile în zaharuri să fie prea ridicate pentru anumite tipuri de vin specifice unor podgorii. În lucrarea de față au fost studiate soiurile românești vechi, mai puțin cultivate în prezent și care pot fi reconsiderate pentru sortimentele actuale din podgorii. S-au luat în studiu: Ardeleancă, Braghină, Cruciuliță, Cionic, cultivate în colecția ampelografică a USAMV Iași. Aceste soiuri în trecut făceau parte din vechile sortimente ale podgoriile românești, fiind cultivate înainte de invazia filoxerei și dădeau nota de originalitate specifică fiecărei podgorii. Multe din ele au o comportare meritorie, în cât pot fi luate în evidență în noile lucrări de zonare ale viței de vie din România.

**Cuvinte cheie:** soiuri vechi românești, încălzire globală, noi lucrări de zonare în podgorii.

## INTRODUCTION

Mankind is currently on the brink of unprecedented, unseen crisis in history, which will deepen and persist in the long run. The big problems arise

<sup>1</sup>University of Agricultural Sciences and Veterinary Medicine Iasi, Romania

from the imminent exhaustion, in the foreseeable future, of vital natural resources - energy, minerals, drinking water, fertile soils, wooded areas and so on. Europe's geographic configuration provides a climate diversity for the vine culture (Cichi, 2006). The climates are subject to fluctuations / permanent changes due to their evolution over time and the action of the anthropic factors (deforestation, lakes, changes in natural water courses, etc). Until recently, grape harvesting periods were clearly defined, it is now unclear when it is optimal to harvest (Țârdea *et al.*, 2001). Experts working with the wine industry are of opinion that temperatures will rise by 1-2 degrees Celsius from now until 2050 and this will increase the incidence of extreme weather events (Dobrei *et al.*, 2017). Some grape varieties are more, others are less affected, it is certain that last years have clearly affected wine production and its quality (Rotaru *et al.*, 2002). In this context, the redefinition of zoning works and the introduction of ancestral varieties that have proven useful over time have to be taken into account.

## MATERIAL AND METHOD

The measurements were carried out in the Ampelographic Collection of the Faculty of Horticulture, situated on a land with a slope of about 5%, on a cambic chernozem soil. The old Romanian varieties from which table wines are frequently obtained are taken into account, namely: Ardeleancă, Braghină, Cruciuliță, Cionic. The rootstock used is Berlandieri x Riparia Kober 5 BB, and planting distances are 2.2 / 1.2 m, with a vertical monoplane trellis system and an average of 3700 plants / ha. The used system in the plantation is semi-high, with a trunk of 0.75 m, bilateral cord with pruning into spur + shoot of 4-7 buds and attribution of 40-42 eye / plant, about 14-16 eyes / m<sup>2</sup>. Soil and vine maintenance works are those specific to the industrial viticultural ecosystem.

## RESULTS AND DISCUSSIONS

Iasi vineyard is situated in a temperate continental climate of forest steppe characterized by harsh winters, warm summers and droughts. The ecological framework meets the biological requirements of varieties for white wines.

***Development of vegetation phenophases*** (tab. 1). It was observed that the Ardeleancă variety (22.04) had an earlier budding than the other observed varieties, Cioinic and Braghină having a difference of one day, and Cruciuliță has a difference of three days. Concluding on the development of the planting phenophase of budding of vine varieties studied in the Copou - Iasi ecosystem, it is observed that this phenophase takes place between 22.04 - 25.04, the differences being given by the biological characters specific to each variety.

Somewhat larger differences arise between Ardeleancă (22.04) and Cruciuliță (25.04). The earlier budding of varieties expose them to the danger of the late spring freeze, which, under the conditions of the N-E Moldavia, occur until the beginning of May. From the data analysis, it was found that this phenophase was carried out within a maximum of 7 days, with no differences between varieties.

In the case of the second phase of vegetation, blooming is observed in the Ardeleancă and Braghină varieties in June 8<sup>th</sup>. For Cioinic variety blooming occurred on June 10<sup>th</sup> and on Cruciuliță on 11<sup>th</sup> June.

The grape veraison begins with the Braghină variety (20<sup>th</sup> of July) and continues with Ardeleancă (August 15<sup>th</sup>), Cioinic (August 17<sup>th</sup>) and the latest is that of the Cruciuliță variety (August 18<sup>th</sup>).

Table 1.

**Development of vegetation phenophases of grape varieties in Iasi vineyard**

Grape variety	Budding	Flowering	Veraison	Grape maturation	Leaf fall
Ardeleancă	22.04	08.06	15.08	20.09	23.10
Cioinic	23.04	10.06	17.08	28.09	28.10
Cruciuliță	25.04	11.06	18.08	30.09	28.10
Braghină	23.04	08.06	20.07	25.08	23.10

The grape maturation of the varieties takes place between August 25<sup>th</sup> and September 30<sup>th</sup>, beginning with the Braghină variety, continued with Ardeleancă (20.09), Cioinic (28.09) and Cruciuliță (30.09).

The cycle of the active vegetation period of the white grape variety ended after 160-170 days, between 23<sup>rd</sup> and 28<sup>th</sup> of October, with the first of autumn frosts, marked by the fall of the leaves.

**Fertility and productivity of varieties** (tab. 2). Generally, the studied varieties have high fertility except for the Cioinic variety, where the percentage of fertile shoots is 66.83%. The other varieties have on average between 79.03% and 82.20% fertile shoots.

Fertility coefficients have high values for the variety Cruciuliță c.f.a. = 1.40; c.f.r. = 1 and Cioinic c.f.a. = 1.37; c.f.r. = 0.92. Instead, productivity indices are higher for varieties that also have a higher weight for a grape, such as Braghină varieties i.p.a. = 234.54; i.p.r. = 196.10 and Cioinic i.p.a. = 237.71; i.p.r. = 158.64.

Table 2

**Fertility and productivity of grape varieties in Iasi vineyard**

Grape variety	% fertile shoots	Abs. fertility coeff.	Relative fertility coeff.	Abs. prod. index	Relative prod. index
Ardeleancă	79.03	1.28	1.01	186.25	147.51
Cioinic	66.83	1.37	0.92	237.71	158.64
Cruciuliță	79.33	1.40	1.00	234.30	188.99
Braghină	82.20	1.31	1.08	234.54	196.10

**Quantity and quality of grape production** (tab. 3). The highest yields are registered for Cioinic varieties of 5.294 kg / plant and Ardeleancă 6.510 kg/vine. The other two varieties with smaller yields Cruciuliță 4.840 kg/vine and Braghină 4.3 kg/vine. The yields per hectare were: Ardeleancă 24.65 t/ha, Cioinic 20.04t/ha, Cruciuliță 18.32 t/ha, Braghină 16.28 t/ha.

Qualitatively, the accumulations in sugars range from 193 g/L to Cioinic and 165 g/L in Braghină. They are specific to varieties for wines without DOC or with GI, since they require harvesting when grapes are fully matured. The total acidity of the must is within the normal range, characteristic of white wine varieties.

Table 3

Quantity and quality of grape production in Iasi vineyard

Grape variety	Average weight of grape (g)	Mass of 100 berries (g)	Total grape production		Sugars (g/L)	Total acidity (g/L H <sub>2</sub> SO <sub>4</sub> )
			kg/plant	Calc./ha		
Ardeleancă	150	265	6.510	24.65	175	4.95
Cioinic	171	226	5.294	20.04	193	4.84
Cruciuliță	166	201	4.840	18.32	184	4.46
Braghină	170	240	4.300	16.28	165	4.89

## CONCLUSIONS

1. The Ardeleancă, Cioinic, Cruciuliță and Braghină varieties have satisfied the biological requirements in ecoclimatic conditions of the Iasi vineyard. They start vegetation in the second part of April, being protected from the danger of late spring freeze, and grapes are matured in the IV-V eras.

2. Fertility of the varieties is generally high, with the exception of the Cioinic variety, with a percentage of 66.83% fertile shoots.

3. Grape yields are high, for Ardeleancă varieties of 24.65 t/ha and Cioinic 20.04 t/ha.

4. Sugar accumulations are specific for grape varieties for wines, since harvesting took place at full maturing, which ensures balanced wines with a freshness characteristic of the more northerly vineyards.

## REFERENCES

1. Cichi Daniela Doloris, 2006 - *Modificările termice din ecosistemul viticol*. Editura Universitaria, Craiova.
2. Dobrei A., Rotaru Liliana, Dobrei Alina, 2017 – *Viticultură, Ampelografie, Oenologie*. Editura Solness, Timișoara.
3. Rotaru Liliana, Țârdea C., Mustea M., 2002 – *Behaviour of some new varieties of table grapes, created at S.C.H. Cluj-Napoca, in the ecoclimatic conditions of the Iasi vineyard*. *Lucrări Științ. U.A.M.V. Iași, seria Hortic.* vol. 1 (45), p. 215-218.
4. Țârdea C., Rotaru Liliana, Mustea M., 2001 – *Precocitatea sau timpurierea soiurilor de viță de vie și calitatea producției de struguri în podgoriile septentrionale*. *Lucrări Științ. U.S.A.M.V. Iași, seria Hortic.* vol. 44, p. 239-242.

## BEHAVIOUR OF VARIOUS ROOTSTOCKS ON DIFFERENT TRELLISING SYSTEMS IN IAȘI VINEYARD

### COMPORTAREA UNOR SOIURI DE VIȚE PORTALTOI CULTIVATE PE DIVERSE MIJLOACE DE SUSȚINERE ÎN PODGORIA IAȘI

ROTARU Liliana<sup>1\*</sup>, COLIBABA Lucia Cintia<sup>1</sup>, CIMPOI V.I.<sup>1</sup>

\*Corresponding author e-mail: lirotaru@uaiasi.ro

**Abstract.** The appearance of the phylloxera on the European continent has in time led to a radical change in the system of vine propagation and cultivation, namely the transition to grafted vine-growing and the use of phylloxera -resistant American species as rootstocks. Cultivated in general to obtain cuttings for the rooting and grafting of grape varieties, rootstock varieties are an important factor in wine production. Therefore, the establishment of specific technological links for rootstock cultures should be the focus of specialists in viticulture. In the present study, during the year 2017 three varieties of rootstocks were studied, namely Berlandieri Riparia Kober 5 BB, Berlandieri Riparia Selection Oppenheim 4 and Chasselas Berlandieri 41 B, all cultivated in the ampelographic collection of USAMV Iași. Each of these varieties was trellised on the following systems: a 4 legged pyramid, a monoplane trellis with diagonal vine training and a T-shaped horizontal trellis. Following the studies, it was found that although the length of the canes was higher at pyramid training, the percent to the length of the matured wood was registered in the monoplane trellis with diagonal vine training. The weakest results were registered in the lead in T-shaped horizontal trellis.

**Key words:** rootstocks, different trellising systems, production of cuttings

**Rezumat.** Apariția filoxerei pe continentul european a determinat în timp o schimbare radicală a sistemului de înmulțire și cultură a viței-de-vie, respectiv trecerea la sistemul de viticultură altoită și utilizarea speciilor americane, rezistente la filoxeră, drept portaltoi. Cultivate în general pentru obținerea butașilor în vederea înrădăcinării și altoirii soiurilor de viță roditoare, soiurile de portaltoi constituie un factor important al producției viticole. Prin urmare stabilirea verigilor tehnologice specifice culturi vițelor portaltoi trebuie să stea în atenția viticultorilor. În lucrarea de față au fost studiate, pe parcursul anului 2017, trei soiuri de vițe portaltoi și anume: Berlandieri Riparia Kober 5 BB, Berlandieri Riparia Selecția Oppenheim 4 și Chasselas Berlandieri 41 B, cultivate în colecția ampelografică a USAMV Iași. Fiecare din aceste soiuri au fost conduse pe următoarele sisteme de conducere a vițelor: piramidă cu 4 butuci, spalier monoplan cu conducerea oblică a lăstarilor și spalier orizontal în formă de T. În urma studiilor efectuate se constată că deși lungimea coardelor a fost mai mare la conducerea pe piramidă, procentul de lemnului maturat a fost cea mai mare la conducerea sub formă de spalier monoplan cu conducerea oblică a lăstarilor. Cele mai slabe rezultate s-au constatat la conducerea sub formă de spalier orizontal sub formă de T.

**Cuvinte cheie:** portaltoi, sisteme de conducere, producție de butași

<sup>1</sup>University of Agricultural Sciences and Veterinary Medicine Iasi, Romania



## INTRODUCTION

Multiplication or reproduction in plants is a fundamental biological process, its basis being heredity (genetic information). In viticulture, the purpose of multiplication is determined by maintaining valuable attributes/quality of varieties and ensuring the need for plants for the establishment of vineyards (Corbean, 2011). The rootstock plantation is one of the important nursery production sectors that provide rootstock cuttings for grafting. The rootstocks come from American vineyards and are characterized by higher demands on climatic factors compared to *Vitis vinifera*: long vegetation ( $\geq 190$  days) and high heat demand (active thermal balance  $\geq 3100$  °C), higher temperatures in August and September when mature tissues mature ( $> 21$  °C and  $180$  °C respectively) (Dobrei *et. al.*, 2017).

## MATERIAL AND METHOD

The measurements were carried out in the Ampelographic Collection of the Faculty of Horticulture, located on a land with a slope of about 3%, on a cambic chernozem soil. The varieties of rootstocks used in the Iasi vineyard are taken into account, namely Berlandieri x Riparia Kober 5 BB, Berlandieri Riparia Selection Oppenheim 4 and Chasselas Berlandieri 41B. Planting distances of 2.2 / 1.8 m, with the monoplane trellis with diagonal vine training, a 4 legged pyramid and a T-shaped horizontal trellis. The average planting density is 2500 plants / ha. Cutting was done in 1-2 cm spurs on all three support systems. The determinations made were the average number of shoots /vine, the total length of the shoot, the useful length of the shoot, % of the matured wood, % of the cuttings, the number of cuttings /vine, the number of cuttings / hectare calculated. Soil and vine maintenance works are those specific to the industrial viticultural ecosystem.

## RESULTS AND DISCUSSIONS

When choosing the trellising means for the rootstocks, it is necessary to take into account a number of factors, namely the possibility of ensuring the maximum length of the shoot and, implicitly, of the matured wood; the intensity of secondary shoots and their growth; the possibility to harness the radiant heat of the soil; ease of execution of agro-technical works; the losses caused by climatic accidents (hail, early autumn freeze) (Amaradei, 2010).

The average number of shoots per vine (tab. 1) depended on the genetic nature of the varieties ranging from 9-12 shoots in the case of varieties like Berlandieri x Riparia, a high vigour variety and 8-10 shoots in the case of Chasselas x Berlandieri 41 B, medium vigour variety.

The length of the shoots was higher at the pyramid system in all varieties (7.19-5.23 m), and the smallest in the T-shaped horizontal trellis (4.18-3.43 m).

Table 1  
Productive characteristics of studied vine rootstocks

Specification	Berlandieri x Riparia Selection Oppenheim 4			Berlandieri x Riparia Kober 5 BB			Chasselas x Berlandieri 41 B		
	diagonal vine training	Pyramid	T Horizontal training	diagonal vine training	Pyramid	T Horizontal training	diagonal vine training	Pyramid	T Horizontal training
Average no. shoots/vine	10	11	9	11	12	10	9	10	8
Total length of shoot (m)	5.64	6.66	5.21	5.94	7.19	5.43	4.89	5.23	4.57
Useful length of shoot (m)	4.96	5.53	3.96	5.29	6.11	4.18	4.40	4.50	3.43
Percentage of matured wood	88	83	76	89	85	77	90	86	75
Percentage of losses from pruning	15	18	20	13	19	21	13	15	18
No of cuttings/vine	14	15	10	15	17	11	13	12	9
Calculated no of cuttings/ha	135000	145500	125000	137500	142500	127500	132500	130000	122500

The total length of the matured wood was highest in the case of the pyramid trellising system (6.11 – 4.50 m) while the lowest was in the case of T-shaped horizontal system (4.18-3.43 m).

The highest percentage of matured wood was recorded in the monoplan trellis systems with diagonal vine training (over 88%), while low values (75-77%) were specific to the T-shaped horizontal system.

Cutting losses were within the specific limits (15-20%), the fewest being recorded for the Kober 5 BB and 41 B varieties in the form of a vertical trellis with diagonal vine training (13%) and the largest ones in the Kober 5 BB, which is extremely vigorous, led as the T-shaped horizontal trellis (21%).

The number of cuttings per vine and implicitly the production per hectare were below the species specifics given the ancient position to the northern vineyard culture limit of the Iasi vineyard. In vigorous varieties, the light exhibition favoured large pyramid-producing productions, namely 145500 vines/ha at SO<sub>4</sub> and 142500 vines/ha in Kober 5 BB. In the middle-sized variety 41 B the largest production was in the form of a vertical trellis with diagonal vine training of the shoots 132500 vines/ha.

## CONCLUSIONS

1. The useful length of the shoot was the largest in the form of pyramids, and the smaller one in the T-shaped horizontal system with the horizontal direction of the shoots.

2. Cuttings were the most quantitative in vigorous varieties in the form of pyramids, while the lead in the form of a vertical trellis with diagonal vine training, more suited to middle-vigour varieties.

3. T-shaped horizontal treadmill leads to smaller vegetative growths with productions below the specific of the varieties, often the growth of main shoots being slowed by strong secondary growth.

## REFERENCES

1. **Amaradei Elena, 2010** - *Cercetări privind obținerea butașilor de portaitoi prin conducerea liberă pe sol și comportarea acestora în scoala de vițe și în plantația de vie pe rod*. Teză de doctorat, USAMV București
2. **Corbean D.G., 2011** - *Tehnologii noi de producere a materialului săditor viticol, în podgoria Târnave*. Teză de doctorat, USAMV Cluj-Napoca
3. **Dobrei A., Rotaru Liliana, Dobrei Alina, 2017** – *Viticultură, Ampelografie, Oenologie*. Editura Solness, Timișoara

## EVALUATION OF NEW GRAPEVINE VARIETIES AND PERSPECTIVE ELITES IN GENOFOND OF ISPHTA

### EVALUAREA UNOR SOIURI ȘI ELITE DE PERSPECTIVĂ DE VIȚĂ DE VIE ÎN CONDIȚIILE GENOFONDULUI ISPHTA

SAVIN GH.<sup>1\*</sup>, CORNEA V.<sup>1</sup>, TOFAN SVETLANA<sup>1</sup>,  
BÎRSA ELENA<sup>1</sup>, BACA I.<sup>1</sup>, BOTNARENCO A.<sup>1</sup>

\*Corresponding author e-mail: ghsavin@yahoo.com

**Abstract.** *In the paper are presented the agrobiological and ampelographic characteristics of the new varieties and elites, created and highlighted in the Republic of Moldova (National Institute of Vine and Wine, currently Scientific and Practical Institute for Horticulture and Food Technologies). Presented genotypes possess separately or in different combinations the characteristics necessary for a sustainable, competitive vitiviniculture: quality, including a different degree of seedlessness, productivity, increased or enhanced resistance to extreme fluctuations of temperature (in winter and in summer), to cryptogamic diseases, diverse use, long-term storage, transportability. The diversity of presented characters and properties is a valuable potential for completing existing assortment; serves as the basis for the development of organic production and as a strategic pre-breeding fund in future breeding programs.*

**Key words:** grapevine, varieties, elites, assortment, breeding, resistance

**Rezumat.** *În lucrare sunt prezentate însușirile agrobiologice și caractere ampelografice pentru soiurile noi și elitele, create și evidențiate în Republica Moldova (Institutul Național al Viei și Vinului, actualmente Institutul Științifico-Practic de Horticultură și Tehnologii Alimentare). Genotipurile prezentate posedă separat sau în diferite combinații caracterele necesare unei vitiviniculturi sustenabile, competitive: calitate, inclusiv grad diferit de apirenție, productivitate, rezistență sporită sau avansată la fluctuațiile extreme de temperaturi iarnă/ vară, la bolile criptogamice, utilizare diversă, păstrare îndelungată, transportabilitate. Diversitatea caracterelor și însușirilor prezente constituie un potențial valoros pentru completarea sortimentului existent, servește ca bază pentru elaborarea producției eco și ca fond strategic bre-breeding în viitoarele programe de ameliorare genetică.*

**Cuvinte cheie:** vița de vie, soiuri, elite, sortiment, ameliorare, rezistență

## INTRODUCTION

The global area under vines is 7.5 million ha, and from global grape production, estimated in 2016 to 7.5 million quintals, 35.8% were used for fresh consumption, for wine production - 47.3%, for raisins (dried grapes) - 8.0% and

---

<sup>1</sup> Research and Practical Institute for Horticulture and Food Technologies, Chișinău, Republic of Moldova

for juice and must production - 5.5% (OIV statistical report, 2017). According to the same source, the Republic of Moldova, with a total area under vines of about 140 thousand ha, ranked 13th in the world after this indicator, after the volume of wine produced (estimated at 1.7 million hl) - 19th place and 12th place after export volume (1.2 mhl). The vitiviniculture sector remains an important one for the country's economy, with the potential to diversify the market with products of high nutritional and curative value, and to develop effective value chains.

The location of the republic's territory at the northern limit of the industrial viticulture essentially influences the efficiency of the branch. The creation in the Republic of Moldova and the implementation in production of new varieties, including seedless, with genetic resistance to abiotic and biotic unfavorable factors (Savin, 2012; Catalog of varieties, 2018), is a decisive factor in diminishing economic losses, in ensuring food safety and security, and the development and implementation of other varieties with similar economic efficiency increases this contribution. Some initial assessments of varieties and perspective elites resulting from these breeding programs are presented in this paper.

## MATERIAL AND METHOD

The studies were carried out during the period 2009-2017 within the grapevine Genofond located at the Scientific-Practical Institute of Horticulture and Food Technologies (southern part of Chisinau city). The weather conditions of the experimental plots correspond to the conditions of the Codru wine region of the Republic of Moldova

In study were included new varieties, elites created in the Republic of Moldova: seedless genotypes I-15-15, I-5-68, II<sub>2</sub>-1-97, II<sub>2</sub>-13-66, Apiren roz (v.II) and genotypes with seeds Basarabia, I-2-24, I-5-58, II<sub>2</sub>-11-19, Gen Piticul (fig. 1).

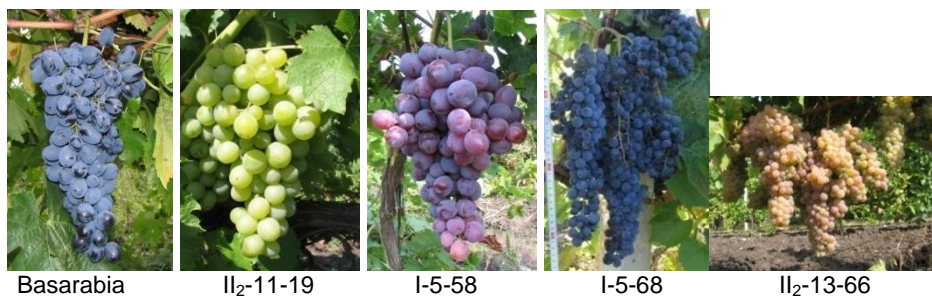


Fig. 1 Genotypes included in study

Planting scheme is 3.0 x 1.25 m, the training system is a bilateral cordon on the high trunk (60 cm). The total number of eyes left on cutting, the number of buds started in vegetation, the number of shoots, including the number of fertile shoots, the number of grapes, the size (length, width) and the weight of the grapes and berries were determined. The ampelographic description was performed according to the OIV Descriptor (2009).

The processing of the experimental data, the graphical presentation was done with the STATISTICA 7.0 software package.

## RESULTS AND DISCUSSIONS

In order to determine the degree of adaptation of these genotypes to the wintering conditions and the evaluation of the productive potential, were determined the number of buds started in the vegetation and the formation of the fruitful elements - the number of shoots and inflorescences, the percentage of fertile shoots, the absolute (AFC) and relative (RFC) fertility coefficients, absolute (API) and relative (RPI) productivity indices (tab. 1, fig. 2).

Table 1

Indexes of fertility and productivity for new varieties and perspective elites  
(average for 2009-2016)

Name of genotype	Fertile shoots, %	AFC	RFC	Average weight of bunch, g	API*	RPI**
Seedless varieties						
I-15-15	77.5±3.3	1.62±0.05	1.26±0.09	237.8±28.9	385.2	299.6
I-5-68	66.8±4.7	1.26±0.04	0.82±0.06	304.9±41.6	384.2	250.0
II <sub>2</sub> -1-97	66.8±4.9	1.31±0.03	0.88±0.08	397.4±49.8	520.6	349.7
II <sub>2</sub> -13-66	63.9±4.4	1.28±0.07	0.81±0.08	360.7±51.1	461.7	292.2
Apiren roz (v.II)	53.2±7.3	1.13±0.06	0.62±0.10	384.9±51.5	434.9	238.6
Seedy genotypes						
Basarabia	38.2±6.1	1.06±0.02	0.42±0.07	320.5±45.1	339.7	136.6
I-2-24	77.9±4.0	1.75±0.06	1.37±0.10	150.8±16.1	263.9	206.6
I-5-58	53.3±4.9	1.10±0.03	0.60±0.07	767.3±84.6	844.0	460.4
II <sub>2</sub> -11-19	66.5±4.7	1.36±0.09	0.91±0.10	284.5±35.8	386.9	258.9
Gen Piticul	78.4±2.7	1.49±0.05	1.16±0.07	199.2±17.0	288.8	231.1

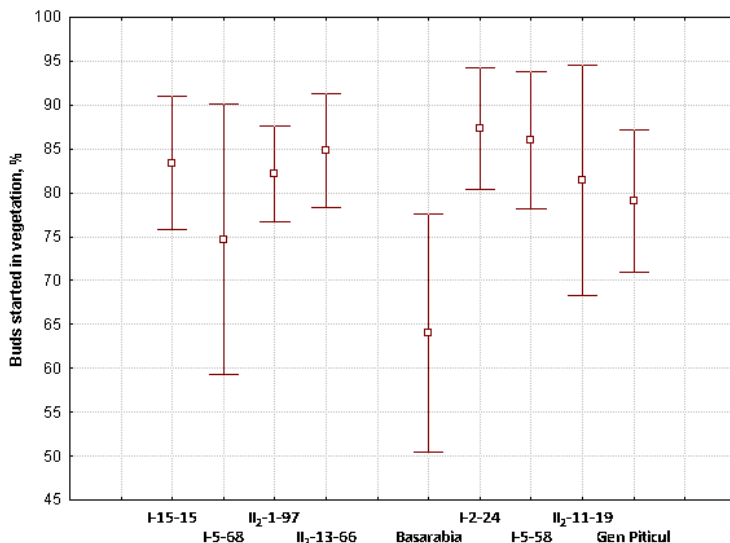


Fig. 2 Percent of buds started in vegetation  
(□ – mean value; I - 95% confidence interval)

In the group of seedless genotypes, the average percent of fertile shoots range from 53.2% for Apiren roz (v.II) to 77.5% for the elite I-15-15, the latter being also characterized by the higher percentage of shoots with 2 inflorescences (about 30%). For the group of seedy genotypes is revealed a more pronounced variability after this index, the values being between 38.2% (Basarabia variety) and 78% (I-2-24 and Gen Piticul). In this group are manifested by the increased percentage of shoots with 2 inflorescences the genotypes Gen Piticul (44%) and I-2-24 (62%).

Table 2

Ampelographic characteristic of new varieties and perspective elites

Name of genotype	Mature leaf				Bunch			
	OIV 067	OIV 068	OIV 076	OIV 081-1/083-2	OIV 202	OIV 203	OIV 208	OIV 502
<b>Seedless varieties</b>								
I-15-15	4	2 3	3	1/9	9	5	1	3
I-5-68	4	2 3	5	1/1	9	5-7	1	3
II <sub>2</sub> -1-97	4	2 3	3	1/1	5	5	3	3-5
II <sub>2</sub> -13-66	4	2	3	1/1	5	5	3	3-5
Apiren roz (v.II)	2	3 4	4	1/1	7	5	1	3-5
<b>Berry</b>								
	OIV 220	OIV 221	OIV 223	OIV 225	OIV 236	OIV 503	OIV 505	OIV 506
I-15-15	3-5	3-5	2	1	1	1-3	5	1-3
I-5-68	3	3	2	6	1	1	7	3
II <sub>2</sub> -1-97	5	5	2	1	2	3	5	5
II <sub>2</sub> -13-66	5	3	3	2	1	1-3	5-7	3-5
Apiren roz (v.II)	5	5	2	5	5	3-5	5-7	3
<b>Seedy genotypes</b>								
	Mature leaf				Bunch			
	OIV 067	OIV 068	OIV 076	OIV 081-1/083-2	OIV 202	OIV 203	OIV 208	OIV 502
Basarabia	2	3	5	1/1	5-7	5	2	3-5
I-2-24	4	1 2	2	1/1	3	3	1	1
I-5-58	2	3 4	3	1/1	7	7	2	7
II <sub>2</sub> -11-19	4	2	3	1/1	5	5	2	3
Piticul	4	2	2	9/1	5	3-5	1	1-3
<b>Berry</b>								
	220	221	223	225	236	503	505	506
Basarabia	7-9	5	6	6	1	5	5-7	3-5
I-2-24	3	3	2	6	1	1	7	3-5
I-5-58	9	7	6	2 5	1	7	5	3-5
II <sub>2</sub> -11-19	5-7	5	2-3	1	1	5	7	3
Piticul	7	5	3	1	1	5	5	3-5

In the study years, with severe temperatures of -26...30°C in some winters (2010, 2012, 2014), most of the genotypes were manifested by the increased

percentage of buds started in vegetation (80-85 %) (Fig. 2). The variability of this index, characterized by the coefficient of variation  $C_v, \%$ , over the years shows a pronounced homogeneity for most genotypes -  $C_v < 30\%$  for I-5-68, II<sub>2</sub>-13-66, Apiren roz (v.II), I-2-24, I-5-58, II<sub>2</sub>-11-19, Gen Piticul, and therefore a stability in their successful wintering in various weather conditions.

Characterizing the size of the grapes according to their length (OIV 202), we find in the group of seedless genotypes a variability from medium grapes to large and very large grapes (I-15-15, I-5-68) and according the weight (OIV 502) - small-medium grapes (tab. 2). Within the group of seedy genotypes, most of them are with medium-sized grapes in length and various by weight - small (I-2-24, Gen Piticul), small-medium (Basarabia) and large (I-5-58).

The size and weight of the berry (OIV 220 and OIV 503) are important characteristics for the commercial aspect of grapes intended for fresh consumption. For all seedless genotypes, the berries are small to medium or medium in length and small in weight, with the exception of the variety Apiren roz (v.II) with medium berries. In the group of seedy genotypes predominate grapes with large and very large berries, and according the weight of berry - medium or large. All genotypes provide an accumulation of sugars and total acidity in must (OIV 505 and OIV 506) favorably for consumption of fresh grapes or for technological processing. Preliminary tests indicate long-term storage and transport availability for the Basarabia variety, the elites II<sub>2</sub>-11-19 and II<sub>2</sub>-1-97.

The evaluation of the main phenological phases (table 3) denotes for the most of studied genotypes a period of about 140-150 days from the time of bud burst to full maturity of the berries, being classified at the late or very late maturation period. It is evidenced by the middle - middle-late maturation genotype with seeds II<sub>2</sub>-11-19 (first decade of September) and seedless genotypes I-15-15, I-5-68, Apiren roz (v.II) (middle of September).

Table 3

**Main phenological phases of new varieties and perspective elites  
(average for 2009-2016)**

Name of genotype	Time of bud burst	Time of fool bloom	Beginning of ripening	Time of full maturity	Interval bud burst – maturity, days
Seedless varieties					
I-15-15	26.04	07.06	07.08	14.09	146
I-5-68	25.04	01.06	26.07	14.09	143
II <sub>2</sub> -1-97	23.04	06.06	02.08	22.09	147
II <sub>2</sub> -13-66	24.04	31.05	28.07	21.09	150
Apiren roz (v.II)	17.04	10.06	28.07	12.09	142
Seedy genotypes					
Basarabia	28.04	05.06	02.08	17.09	142
I-2-24	27.04	30.05	12.08	30.09	158
I-5-58	26.04	05.06	30.07	29.09	158
II <sub>2</sub> -11-19	25.04	04.06	26.07	08.09	137
Gen Piticul	27.04	05.06	13.08	25.09	152



At an initial assessment (visual, in field conditions) was established an increased or advanced resistance of these genotypes to cryptogamic diseases - a prerequisite for reducing the number of chemical treatments of future vineyards, the possibility of using the grapes to produce eco production.

The described genotypes, through the range of agrobiological traits that characterize them, are a valuable biological material, a pre-breeding strategic fund for future breeding programs. For elite I-15-15, for example, there was found an increased regenerative potential of immature embryos (Chiriac *et al.*, 2007), with great perspectives to engage in assortment amelioration, including according the seedless X seedless cross scheme.

## CONCLUSIONS

The studied genotypes have a variety of characters favorable for completing and diversifying the assortment: middle - middle-late maturation period; a wide range of color of berry skin - green-yellow, pink, black-violet, black-blue; seedlessness; muscat or specific flavors; medium, large or very large grapes and berries; increased fertility, biological resistance, diverse use.

The presence, separately or in various combinations of high quality, including seedlessness, productivity, resistance, other useful features, presents a criterion for their inclusion in the pre-breeding germplasm fund for further use in the improvement of the grapevine assortment.

## REFERENCES

1. Chiriac Gh., Savin Gh., Smerea S., 2007 - *Embryo rescue in seedless genotypes*. În: *Lucrări științifice, Universitatea de Științe Agricole și Medicină Veterinară „Ion Ionescu de la Brad” Iași, Seria Horticultură*, anul L (50), p. 39-44.
2. Savin Gh., 2012, - *Ameliorarea sortimentului viticol al Republicii Moldova*. Ch. : S.n., (Tipogr. AȘM). 260 p.
3. \*\*\*, 2009 – *OIV Descriptor List for Grapevine Varieties and Vitis species (2<sup>nd</sup> Edition)*. Office International de la Vigne et du Vin, Paris.
4. \*\*\*, 2017 - *2017 World Vitiviniculture Situation*. OIV Statistical Report on World Vitiviniculture. <http://www.oiv.int/js/lib/pdfjs/web/viewer.html?file=/public/medias/5479/oiv-en-bilan-2017.pdf>
9. \*\*\*, 2018, – *Catalogul soiurilor de plante pentru anul 2018*. Ediție oficială. Editura „Lumina”, Chișinău, 132 p.

## THE EFFECT OF THE TREATMENT WITH NAD AND ANA BASED PRODUCT ON THE PRODUCTIVITY AND QUALITY OF LARGE FRUIT

### EFFECTUL TRATĂRII CU PRODUSUL PE BAZĂ DE NAD ȘI ANA ASUPRA PRODUCTIVITĂȚII ȘI CALITĂȚII FRUCTELOR DE MĂR

PESTEANU A. <sup>1\*</sup>

\*Corresponding author e-mail: a.pesteanu@uasmd.md

**Abstract.** *The study subject of the experience was Idared apple variety grafted on M9, trees were trained as slender spindles for distance 3.5 x 0.8 m. To study influence of growth regulator Auxiger (NAD – 1.5 g/L + ANA – 0.6 g/L) on average weight of fruits, fruit production and fruit size were experimented the following variants of treatment: 1. Control – without treatment; 2. Auxiger, 0.9 L/ha; 3. Auxiger, 1.8 L/ha. Growth regulator was sprayed one time, during the period of intensive fruit growing, when the fruits diameter was 22-25 mm (09.06.16). The research was conducted during the period of 2016 year. In the present research work, we demonstrated that Auxiger increase average weight of fruits, fruit production and fruit size and may be included in the technology system for cultivation of apple, applied one spray at 1.8 L/ha when the fruits diameter was 22-25 mm.*

**Key words:** apple, growth regulator, production, color

**Rezumat.** *Ca obiect de studiu a fost luat soiul de măr Idared altoit pe portaltoiul M9, pomii au fost conduși ca fus zvelt ameliorat, distanța de plantare 3,5 x 0,8 m. Pentru a studia influența regulatorului de creștere Auxiger (NAD – 1,5 g/L + ANA – 0,6 g/L) asupra greutateii medii, productivității plantației de măr și diametrului mediu a fructelor au fost montate următoarele variante: 1. Martor - fără tratare; 2. Auxiger, 0,9 l/ha; 3. Auxiger, 1,8 L/ha. S-a efectuat un singur tratament în perioada de creștere intensivă a fructelor, când diametrul lor era de 22-25 mm (09.06.2016). Cercetările au fost efectuate pe parcursul anului 2016. Cercetările, au demonstrat, că regulatorul de creștere Auxiger sporește greutatea medie, producția de fructe și diametrul mediu a lor și poate fi inclus în sistemul tehnologic de cultivare a mărului aplicat o singură dată în doza de 1,8 L/ha când diametrul lor va fi de 22-25 mm.*

**Cuvinte cheie:** măr, regulator de creștere, producție, culoare

## INTRODUCTION

A high quality fruits production can be registered only by using the appropriate modern technologies, according to the specific conditions of each field sector (Babuc, 2012, Cimpoieș, 2012).

In addition to modern techniques and technologies aimed at increasing the production of fruits in quantitative and qualitative terms, an important role is

---

<sup>1</sup> State Agricultural University of Moldova, Chișinău, Republic of Moldova

played by regulators of growth (Babuc *et al.*, 2013; Ghena *et al.*, 2004).

The growth regulators influence and guide the growth and development processes of fruit species, allow increasing the resistance of plants to stress factors etc. (Pesteanu *et al.*, 2017a). Their use in modern agriculture, with high biological and economic efficiency, becomes a necessity (Pesteanu *et al.*, 2017b).

## MATERIAL AND METHOD

The research was conducted during the year of 2016, in the apple orchard founded in autumn 2012 at the enterprise "Codru ST", with knot boom trees.

The object of study of the experience was Idared apple variety grafted on the M9 rootstock. The crown was conducting after the slender spindle system. Planting distance was 3.5 x 0.8 m.

According to the research program within the undertaking concerned of the influence of the NAD + ANA growth regulator, Auxiger product of "L. Gobbi" S.R.L., Italy, the following variants were tested on fruit growing processes (tab. 1).

Table 1

**The scheme of experiments to determine the effectiveness of the Auxiger growth regulator for growing and fruiting apple trees**

Variants	Activ ingredient	Application method
Control, without treatment	-	-
Auxiger – 0.9 L/ha	NAD – 1.5 g/L + ANA – 0.6 g/L	By spraying during the intensive growth of fruits, (09.06.2016)
Auxiger – 1.8 L/ha		

The location of plots was made in blocks, each variant having 4 replicates. Each rehearsal consisted of 7 trees. At the border between parcels and experimental replicates, one untreated tree was left to avoid overlapping variants or rehearsals during the treatments.

Trees treatments were handled with the portable sprinkler in the hours without wind, in the morning with 0.3 liters of solution per tree.

The investigations were conducted in the field and laboratory conditions according to the accepted method of experimentation with growth regulators.

Statistical data processing was performed by the dispersion analysis method.

## RESULTS AND DISCUSSIONS

The growth regulators based on NAD and ANA, are actively involved in the synthesis of chlorophyll, the photosynthesis process and the vegetation of fruit plants.

Treatments with the Auxiger growth regulator have positively influenced the content of chlorophyll "a" and "b" and their sum, as well as the carotenoid content.

In the control variant, the content of chlorophyll "a" was 2.57 mg/dm<sup>2</sup>, and chlorophyll "b" was 0.81 mg/dm<sup>2</sup>. The amount of chlorophyll "a" and "b" in this variant constituted 3.38 mg/dm<sup>2</sup>, and carotenoids 1.20 mg/dm<sup>2</sup> (tab. 2).

After the application of the Auxiger growth regulator during the intensive growth period of the fruits, there was an increase in the content of chlorophyll and

carotenoids in the leaves.

In case of treatment with the Auxiger growth regulator at 0.9L/ha and 1.8L/ha, the content of chlorophyll "a" in leaves increased by 8.9% and 16.3%, respectively, compared to control variant. The above exposure also applies to chlorophyll content "b".

Table 2

**Auxiger growth regulator influence on chlorophyll and carotenoid content in Idared apple variety**

Variants	Content of chlorophyll pigments, mg/dm <sup>2</sup>			Content of carotenoids, mg/dm <sup>2</sup>
	„a”	„b”	„a” + „b”	
Control, without treatment	2.57	0.81	3.38	1.20
Auxiger – 0.9 L/ha	2.80	0.88	3.68	1.27
Auxiger – 1.8 L/ha	2.99	0.96	3.95	1.37

The amount of chlorophyll "a" and "b" in variants treated with the Auxiger growth regulator increased by 8.9-16.8% compared to the control variant.

Treating trees with the Auxiger growth regulator also increased the carotenoid content of the plant, increasing to 1.27 - 1.37 mg/dm<sup>2</sup>. The investigations show that higher levels of chlorophyll "a", "b", "a" + "b" and carotenoids were recorded in the variant treated with the Auxiger growth regulator at a dose of 1.8 L/ha.

Fruit production is the index, which demonstrates how all agro-technical measures have been carried out in the Idared apple plantation.

The amount of fruits in the crown of the trees included in the research does not differ on the variants taken into consideration (tab. 3), because the normalization of the fruit load was made to obtain more reliable data.

The lowest average weight of a fruit was recorded in the control variant, without treatment - 162.8 g. Followed by the variant treated with the Auxiger growth regulator in 0.9 L/ha - 170.1 g and the variant treated with the Auxiger growth regulator at a rate of 1.8 l/ha, where the average weight of a fruit constituted 175.3 g, or an increase of 12.5 g compared to the control variant.

Studying the influence of the treatment dose, we note that with an increase in the amount of product administered from 0.9 L/ha to 1.8 L/ha, the average fruit weight increases, but not as essentially as observed between the variant witness and tested variants. The results outlined above are also confirmed by statistical processing.

Fruit production on a tree and on a surface unit correlates directly with the number of fruits and their average weight. The smallest fruit production was recorded in the control variant, constituting 10.75 kg/tree or 38.4 t/ha.

When treating with Auxiger growth regulator at 0.9 L/ha, the fruit production was 11.23 kg/tree or 40.1 t/ha, or an increase of 4.3% compared to the control variant.

In the variant treated with the Auxiger growth regulator at the rate of 1.8 l/ha, the increase in production was 7.6% compared to the control variant.

Table 3

**Auxiger growth regulator influence on the average quantity, average weight and fruit production of Idared apple variety**

Variants	Quantity of fruits, pcs/tree	Average weight, g	Fruit production		In %, compared to the witness
			kg/tree	t/ha	
Control, without treatment	66	162.8	10.75	38.4	100.0
Auxiger – 0.9 l/ha	66	170.1	11.23	40.1	104.3
Auxiger – 1.8 l/ha	66	175.3	11.57	41.3	107.6
DL 5%	2,8	7.1	0.45	1.52	-

The difference between the variant treated with the Auxiger growth regulator at a dose of 0.9 L/ha and at a dose of 1.8 L/ha was 3.3%, then between the control variant and the variant treated with Auxiger at a dose of 0.9 L/ha recorded 4.3%.

The results obtained (tab. 4) show that the fruit production obtained from the variants in the study differs from one another, registering higher values in case of treatment with the Auxiger growth regulator.

Table 4

**Auxiger growth regulator influence on the redistribution of fruits by their diameter on Idared apple trees**

Variants	The share of fruits (%) according to their diameter (mm)					Average diameter, mm
	61-65	66-70	71-75	76-80	81-85	
Control, without treatment	5.5	24.7	31.3	30.7	7.8	72.5
Auxiger – 0.9 l/ha	-	25.0	33.4	31.5	1.1	74.0
Auxiger – 1.8 l/ha	-	22.7	33.1	32.5	1.7	74.4

Treating trees with Auxiger has improved the quality of fruit production compared to the control variant. That is, in the variant treated Auxiger in dose of 0.9 L/ha the weight of grade I quality fruit was 25.0% and the "extra" category - 75.0%. The above-mentioned law also applies to the Auxiger version at a rate of 1.8 L/ha.

The average fruit diameter is an indicator that correlates directly with the average weight of the yield obtained. A smaller average diameter was recorded in the control variant, where the studied index constituted 72.5 mm, and the highest values were obtained in variants treated with the Auxiger growth regulator, constituting 74.0-74.4 mm, or with 2.1-2.6% higher compared to control variant.

The data of the investigations carried out (tab. 5) shows that the firmness of the apple pulp on the variants in the study at the time of the harvest constituted 7.1-7.4 kg/cm<sup>2</sup>. The smallest firmness of the pulp was recorded in the control variant without treatment - 7.1 kg/cm<sup>2</sup>.

When treating with the Auxiger growth regulator, we record approximately the same values of pulp firmness, 7.3 - 7.4 kg/cm<sup>2</sup>.

The dry matter content of the Idared variety, on variants in the study, is 15.7 - 15.9%. The smallest value of the weight of dry substances was recorded in the control variant - 15.7%. Treatment with the Auxiger growth regulator increased the study index by only 0.2% compared to the control variant.

Table 5

**The influence of the Auxiger growth regulator on the biochemical and coloring indexes of apple Idared variety**

Variants	Firmness, kg/cm <sup>2</sup>	Dry matter, %	Soluble dry substance, %	Titrateable acidity,%	Coloring Index (Points)
Control, without treatment	7.1	15.7	13.6	0.53	3.4
Auxiger – 0.9 L/ha	7.3	15.9	13.7	0.51	4.3
Auxiger – 1.8 L/ha	7.4	15.9	13.8	0.50	4.7

The amount of soluble dry matter in the Idared variety on the variants in the study constituted 13.6 - 13.8%. The smallest value of the weight of the soluble dry substances was recorded in the control variant - 13.6%. In variants treated with the Auxiger growth regulator, we record an increase of the index in the study by 0.1 - 0.2%, compared to the control variant.

Decreasing the amount of soluble substances in fruits increases the share of titrateable acids, registering higher values in the control variant - 0.53%.

In the variant treated with Auxiger growth regulator in dose of 0.9 L/ha, the amount of titrateable fruit in the fruit constituted 0.51%, and the increase of the dose to 1.8 L/ha was 0.50%.

Treating with the Auxiger growth regulator at a dose of 0.9 L/ha increased the coloration to 4.3 points, and with the increase of the dose to 1.8L/ha, the given index constituted 4.6 points.

Simultaneously, with the intensive growth of fruits occurs and the anthogenic induction in plants, that is, the phenophase of initiation of the formation of flowering buds, which can go more reasonably if the plant is assured with an optimal quantity of auxins.

The investigations revealed that the smallest quantity of fruit formations was obtained in the control variant - 117 pcs/tree (tab. 6). In the variants treated with Auxiger growth regulator at 0.9 L/ha, the amount of fruit formations was 133 pieces/tree, but with the increase of the dose to 1.8 L/ha, the study index was 139 pcs/tree.

A more significant difference compared to the control variant was recorded in the variant treated with the Auxiger growth regulator at a rate of 1.8L/ha, where an increase of 18.8% was obtained. This difference between these variants is explained by the fact that the Auxiger growth regulator, whose active ingredient is ANA and NAD, favors the excitability of the axial buds and the obtaining of a larger amount of fruit formations.

Table 6

**The amount and weight of fruit formations in the crown of Idared apple trees under the influence of the Auxiger growth regulator**

Variants	Total quantity, pcs / tree	The share of different types of fruit formations,%			
		Spurs	Brindles	Long shoots	Burses
Control, without treatment	117	43.6	11.1	16.3	29.0
Auxiger – 0.9 l/ha	133	49.6	9.0	11.7	29.3
Auxiger – 1.8 l/ha	139	51.0	9.3	11.6	28.1

The type of fruit formations formed in the crown of apple trees is influenced only by the growth regulator used for the treatment and not by the dose administered to a surface unit.

Treatments with the Auxiger growth regulator recorded an increase in the weight of the spurs against the brindles and long shoots compared to the control variant. The share of burses did not make any major changes to the variants in the study.

## CONCLUSIONS

1. The experimental results revealed that the Auxiger growth regulator can be included in the technological system for improving the physiological processes in the plant, increasing the average weight and the quantity of apple fruit in the dose of 1.8 L/ha.

2. Apply the product once by foliar spraying during the intensive growth of fruits when their diameter is 20-25 mm.

## REFERENCES

1. Babuc V., 2012 - *Pomicultura*. Chișinău, p. 348-354.
2. Babuc V., Peșteanu A, Gudumac E., Cumanici A., 2013 - *Producerea merelor*. Ed. Bonss Office, Chișinău, p.158-169.
3. Cimpoieș Gh., 2012 - *Cultura mărului*. Chișinau, p. 303-337.
4. Ghena N., Braniște N. Stănică Fl., 2004 - *Pomicultura generală*. Ed. MatrixRom, București,, p. 391-422.
5. Peșteanu A., Balan V., Ivanov I., 2017a - *Influence of growth regulator Auxiger on development and fructification of cherry trees*. Journal of Horticulture, Forestry and Biotechnology, 21(2), p. 1-6.
6. Peșteanu A., Balan V., Ivanov I., 2017b - *Effect of Auxiger growth regulator on fruits development, production and cracking index of 'Regina' cherry variety*. Scientific Papers. Horticulture, LXI, p. 137-142.

## ANALIZATION OF PHOTOSYNTHETIC ACTIVITY AND TRANSPIRATION ACTIVITY IN PEAR TREES DEPENDING ON THE ACTION OF BIOLOGICAL ACTIVE SUBSTANCES

### ANALIZA ACTIVITĂȚII FOTOSINTETICE ȘI TRANSPIRAȚIEI LA POMII DE PĂR ÎN DEPENDENȚĂ DE ACȚIUNEA SUBSTANȚELOR BIOLOGIC ACTIVE

SCURTU Gh.<sup>1\*</sup>, BUJOREANU N.<sup>1</sup>, HAREA I.<sup>1</sup>, NICUȚA A.<sup>1</sup>, PAȘA R.<sup>1</sup>

\*Corresponding author e-mail: planeta\_scurtu@yahoo.com

**Abstract:** Research to elucidate the effectiveness of photosynthesis and transpiration intensity in depending on the donor – acceptor process in pear plants has been carried out. The obtained results have shown that the physiological state of the plants during the active of the vegetation period can be characterized depending on the season and the specificity of the vegetation period performance in dynamic of the photosynthesis efficacy and transpiration activity. It has been established that in the spring, during the vegetation period, the pear trees with the increase of the intensity of the photosynthesis and transpiration activity.

**Key words:** Photosynthesis, transpiration, donor – acceptor, pear tree, *Verbascozida*, LCi – 4 Portable Photosynthesis System

**Rezumat:** Cercetările efectuate vizează elucidarea eficacității fotosintezei și transpirației în dependență de donor - acceptor în plantele de pere. Rezultatele obținute au demonstrat, că starea fiziologică a plantelor în perioada activă de vegetație poate fi caracterizată în funcție de sezon și specificitatea perioadei de vegetație în dinamica eficacității fotosintezei. A fost stabilit, că primăvara, în perioada de vegetație, la pomii de păr crește intensitatea fotosintezei.

**Cuvinte cheie:** Fotosinteza, transpirația, donor – acceptor, părul, *Verbascozida*, LCi – 4 - sistem portabil de fotosinteză

## INTRODUCTION

It is known that photosynthetic activity and transpiration intensity in the pear orchard depends on a complex of internal and external factors, which manifest in dynamics on the date of measurements. The intensity of photosynthesis and transpiration is the basic indicator that characterizes the functionality of the photosynthetic apparatus, which is widely used in the scientific and practical physiological investigations. The purpose of the investigations is to evaluate in dynamics the productive potential of the plantation for the production of pear trees, by the capacity of assimilation of the

---

<sup>1</sup> Institute of Genetics, Physiology and Plant Protection of the Academy of Sciences of Moldova, Chisinau, Republic of Moldova



photosynthetic apparatus and transpiration in response to the action of the biologically active substances.

### MATERIAL AND METHOD

The scientific researchers were carried out in the pear orchard of the company "Delectar", Onesti com., Hâncești district. The control pear trees were sprayed with water and the aqueous solution of the Verbascozida natural growth regulator at a concentration of 0.01%. The study investigates the two varieties of late pears Noyabrskaya variety and Vystavochnaya variety. Two weeks later, in dynamics, during the vegetation period, photosynthetic intensity and other 11 parameters (indicated below) were determined in the leaves of the pear trees directly in the orchard, for the first time by using the LCi - 4 Portable Photosynthesis System, presented at the International Conference of Plant Physiology in Poland and donated to the Republic of Moldova by the World Bank for the purpose of linking physiological researches to international standards.

### RESULTS AND DISCUSSIONS

The LCi – 4 (BCI., 1994) device (fig.1) consists of a contact chamber connected to pear leaves, a block composed of two specialized computers: 1 - measures the required parameters, 2 - analyzes the data obtained, which displays them on the screen and accumulates them in memory, where can be removed to a memory card.



Analyzing the above photosynthesis formula (Rabinovich E. 1953., p.287) and fig.1 we note that of the 12 parameters (shown below) by measurements with LCi – 4 Portable Photosynthesis System: 4 parameters refer to CO<sub>2</sub> determination; 2 parameters refer to the determination of H<sub>2</sub>O; 3 - Photosynthetic active radiation, and T – temperature in the measurable room and of the leaf.



**Fig. 1** LCi – 4 Portable Photosynthesis System

1. V - CO<sub>2</sub> flow (reference), VPM
- 2, 3. T, °C – in the measurable room / of the leaf
4. The intensity of photosynthesis,  $\mu\text{mol m}^{-2} \text{s}^{-1}$
5. The intensity of transpiration,  $\text{mmol m}^{-2} \text{s}^{-1}$
6. Conductivity of the stomatas at CO<sub>2</sub>,  $\text{mol m}^{-2} \text{s}^{-1}$
7. Photosynthetic active radiation,  $\mu\text{mol m}^{-2} \text{s}^{-1}$
8. C<sub>an</sub> - CO<sub>2</sub> from exterior, h=3m from the soil, VPM
9. C<sub>j</sub> - CO<sub>2</sub> in the measurable room, VPM
10.  $\Delta C (=C_{\text{ref}} - C_{\text{an}})$ , VPM
11. E<sub>an</sub> –saturation of the air with humidity, mbar
12.  $\Delta E$ -partial pressure, mbar



**Fig. 2** Noyabrskaya variety



**Fig. 3** Vystavochnaya variety

#### Noyabrskaya variety, short description

Noyabrskaya variety (Dushutina, 1979), short description: this pear (*Pyrus*), family *Rozaceae* variety (fig.2) originates from the Republic of Moldova. Winter variety. Standard variety, premium class. Author is Xenia Dușutina. Noyabrskaya is a hybrid of the varieties Nicolai Kriuger x Triumph of Vienna. Spread under the name Xenia. Variety is popular in Europe due to the superior quality of the fruits (a ball of 4, 6 out of 5 possible) and their long-lasting, widely used in the fruit processing industry.

This variety is one of the most resistant to frost, diseases, etc.

It is the most cultivated variety of pears in the Republic of Moldova due to the very large size of fruits, which can reach up to 600 g/one.

When harvesting, the fruits are green and stony, but after several weeks of storage they soften and turn yellow and flavored, with a unique taste.

The harvest is done in October and full maturity reaches in November, hence the name of this particular variety. Under optimal conditions it can be kept until April.

Vystavochnaya variety, short description

This pear (*Pyrus*), family *Rozaceae* Vystavochnaya variety (Dușutina, 1979), (fig. 3) originates from the Republic of Moldova. Autumn variety. Standard variety, premium class. Author is Xenia Dușutina. Vystavochnaya is a hybrid of the varieties Triumph of Vienna x Olyvie de Serr, resistant to winter conditions, fertile. The trees have average growth, born regularly. They are resistant to mane and staining of the leaves. The fruits are large, reaching the weight of 240-350g, are picked at the beginning of October, good taste (ball of 3.8 - 4.0 out of 5 possible), are used for consumption in November-January, under refrigerator storage conditions-in January-February.

Results on the mathematical analysis photosynthetic activity with graphical presentation of the results, Noyabrskaya variety and Vystavochnaya variety.

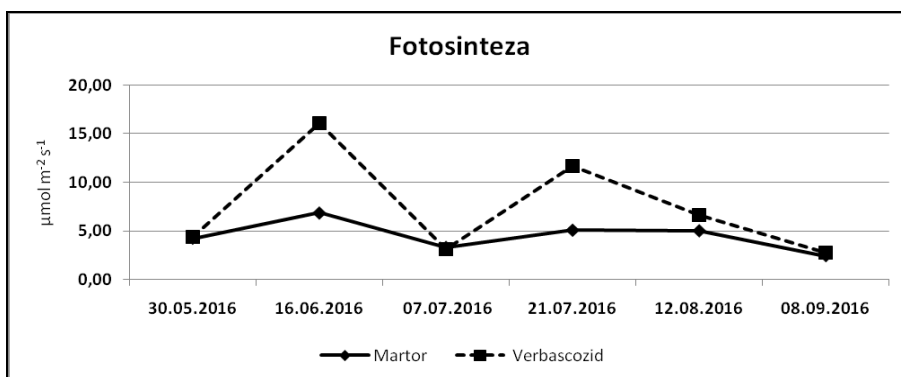
Each measurement includes three rehearsals-mandatory conditions.

Significant - it results that SBA Verbascozida 0.01% has a higher effect compared to the control.

Table1

**Average data for mathematical analysis, Noyabrskaya variety**

Factors	Date of observation					
	30.05. 16	16.06. 16	07.07. 16	21.07. 16	12.08. 16	08.09. 16
Control	4.27±0.6	6.88±0.48	3.32±0.27	5.10±0.65	5.04±0.05	2.46±0.3
Verbascozida 0,01%	4.41±0.09	16.07±1.89	3.13±0.02	11.64±0.33	6.66±0.13	2.78±0.28



**Fig.4** The intensity of photosynthesis in the dynamics of the vegetation period

Average data for mathematical analysis, Vystavochnaya variety

Factors	Date of observation					
	30.05.16	16.06.16	07.07.16	21.07.16	12.08.16	08.09.16
Control	4.22±0.29	3.30±0.11	2.98±0.22	1.61±0.25	4.29±0.44	2.91±0.20
Verbascozida 0.01%	6.81±0.14	6.07±0.47	3.93±0.03	5.44±0.13	5.84±0.18	2.86±0.25

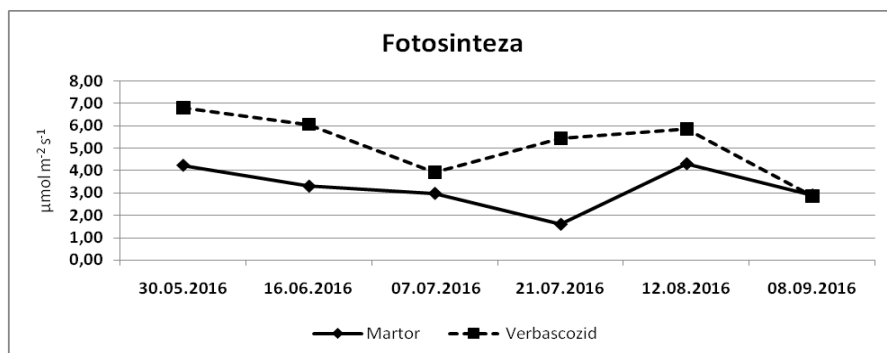


Fig.5 The intensity of photosynthesis in the dynamics of the vegetation period

The Photosynthesis intensity ( $\mu\text{mol m}^{-2} \text{s}^{-1}$ ) represents the quantity of  $\text{CO}_2$  used by an foliar surface, in an unity of time.

The results obtained on both varieties of pears show ensures of the formation of more assimilation centers (donor) in the apical tissues of the pear trees that allow the use (acceptor) of photosynthetic assimilations at the beginning of the intensive growth of shoots, as well of the growth of foliage and fruits (16.06.2016). At the same time, the data obtained demonstrates that the photosynthetic apparatus in the application of SBA *Verbascozida* 0.01% has a significantly higher capacity to insure the needs of pear plants compared to the control (tab.1.2, fig. 4, 5). Similar results by the Klimov S.V. 2008, p.128.

At the end of the vegetation period, when the effectiveness of the photosynthetic active centers diminishes (from 21 July to 08 September 2016), less characteristic for the 07.07.2016 period (because of the sudden cooling of the air and the heavy rains), the ability to synthesize the assimilation becomes equal to their of use and storage by the acceptance centers (donor), which results in the equilibrium of both the control and *Verbascozida* 0.01% variant, the latter being eliminated from the plant (fig.4, 5). Similar results were obtained by the authors (Rubin, 1970, Rabinovich, 1953).

The presence of photosynthesis of the foliage apparatus of the trees during the harvesting period contributes to an increase in the possibilities for preserving fruits.

Results on the mathematical analysis the intensity of transpiration with graphical presentation of the results, Noyabrskaya variety and Vystavochnaia variety.

Each measurement includes three rehearsals-mandatory conditions.

Table 3

Average data for mathematical analysis, Noyabrskaya variety

Factors	Observation data					
	30.05.2016	16.06.2016	07.07.2016	21.07.2016	12.08.2016	08.09.2016
Control	5.35±0.01	1.11±0.01	1.62±0.02	0.54±0.08	0.93±0.01	0.70±0.02
Verbascozida	5.92±0.04	0.74±0.01	1.57±0.20	2.32±0.02	0.75±0.00	1.56±0.02

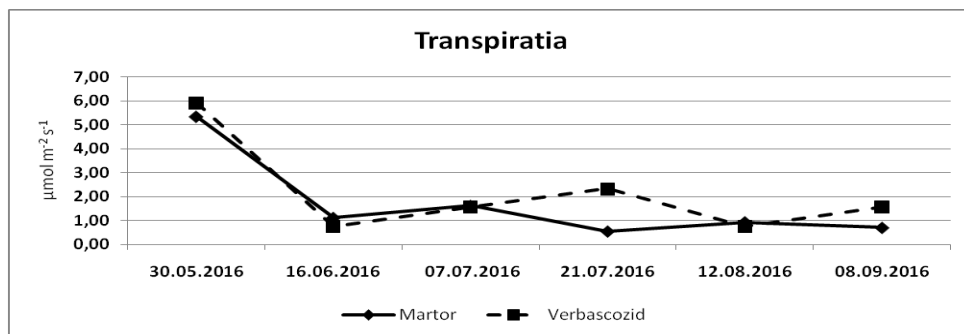


Fig.6 The transpiration in the dynamics of the vegetation period

Table4

Average data for mathematical analysis, Vystavochnaya variety

Factors	Observation Data					
	30.05.2016	16.06.2016	07.07.2016	21.07.2016	12.08.2016	08.09.2016
Control	2.45±0.18	1.31±0.02	1.70±0.08	0.44±0.14	1.29±0.01	0.83±0.03
Verbascozida	4.43±0.11	0.92±0.09	1.32±0.10	0.60±0.03	1.08±0.02	0.87±0.02

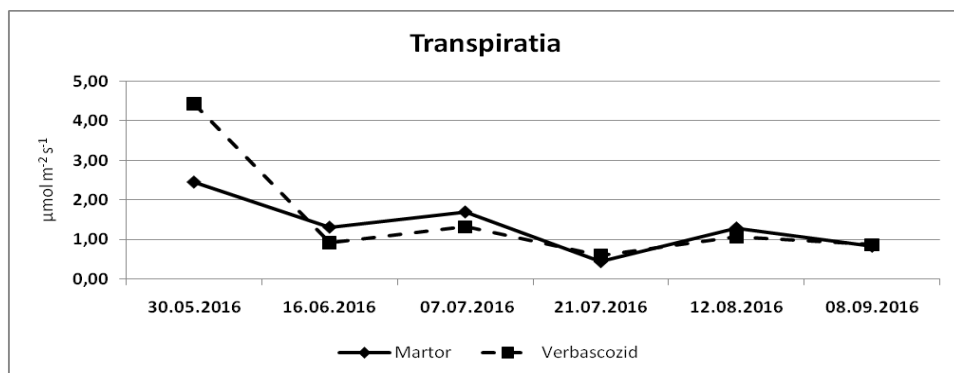


Fig.7 The transpiration in the dynamics of the vegetation period

Transpiration intensity ( $\mu\text{mol m}^{-2} \text{s}^{-1}$ ) represents the quantity of water, which is evaporated by the plant in a period of time, in a leaf surface unite.

Results presented by Noyabrskaya variety in the third and fourth measurements (tab.3, fig.6), and Vystavochnaya variety only in the third measurement (tab.4, fig.4)

present semnificative results, the rest of results being non-semnificative, because there is no separation between them, the results presented in (tab.4, fig. 7).

Table 5

As an example with the results of the second measurement from 16 th July 2016

Indices	Measurement units	From... to...	Noybriskaya		Vystavochnaya	
			Martor	verb.	Martor	Verb.
			08:50	09:50	09:55	10:15
V – CO <sub>2</sub> flow (reference)	VPM	0-2000	380	373	384	382
T, °C – in the measurable room	°C	-5...+50	23.4	28.08	28.9	33.59
The intensity of photosynthes.	μmol m <sup>-2</sup> s <sup>-1</sup>	0-100	7.80	14.49	3.49	7.00
			6.63	19.83	3.30	5.50
			6.21	13.89	3.11	5.70
			<i>media</i>	<i>6.88</i>	<i>16.07</i>	<i>3.30</i>
The intensity of transpiration	mmol m <sup>-2</sup> s <sup>-1</sup>	0-50	1.1	0.74	1.35	1.04
			1.12	0.72	1.29	0.99
			1.12	0.76	1.30	0.74
			<i>media</i>	<i>1.12</i>	<i>0.74</i>	<i>1.31</i>
Conductivity of the stomatas at CO <sub>2</sub>	Mol m <sup>-2</sup> s <sup>-1</sup>	0-100	0.02	0.03	0.04	0.17
			0.04	0.04	0.03	0.16
			0.03	0.04	0.04	0.17
			<i>media</i>	<i>0.03</i>	<i>0.04</i>	<i>0.04</i>
Photosynthetic active radiation	μmol m <sup>-2</sup> s <sup>-1</sup>	0-3000	1090	1049	1367	1286
T, °C – of the leaf	°C	-5+50	31.56	28.08	36.21	35.07
Can – CO <sub>2</sub> outside, h=3m from the soil	VPM	0-2000	405.5	470.6	405.6	396.6
ΔC (=Cref-Can)	VPM	+/-2000	20.1	9.2	8.2	26.6
Cj – CO <sub>2</sub> inside the room	VPM	0-2000	214.5	182.3	122.7	189.4
Ean – air saturation with humidity	Mbar	0-75	15.4	13.4	13.4	12.8
ΔE- partial pressure	Mbar	+/-75	7.6	5.8	5.8	6.3

During winter period feed reserve substances are stored in roots, buds, aerian part of the pear plants (donor) and are used for intensive growth of the pear shoots, leaves and fruits (acceptor).

The measurements (tab. 5) were done at Noyabrskaya, Vystavochnaya variety with LCi-4, from 08:50 to 09:50 and 09:55 to 10:15 at Vystavochnaya variety.

The first measurement (30.05.2016), the second one (16.06.2016) and the third (07.07.2016) took place on the period of maximal growth of the pear shoots, leaves and fruits (tab.3, 4 and fig.6, 7).

The measurement 1, 2 and 3 are presented in table 5 made with LCi-4 in order to reflect the photosynthesis activity.

The intensity of photosynthesis for Noyabrskaya variety includes 6.88 – 16.07 μmol m<sup>-2</sup> s<sup>-1</sup> and for Vystavochnaya variety 3.30 – 6.07 μmol m<sup>-2</sup> s<sup>-1</sup>.

The intensity of transpiration is 0.74 – 1.12 mmol m<sup>-2</sup> s<sup>-1</sup> for Noyabrskaya variety and 0.92 – 1.311 m<sup>-2</sup> s<sup>-1</sup> for Vystavochnaya variety.

Photosynthetic active radiation is 1049-10901  $\text{m}^{-2} \text{s}^{-1}$  at Noyabrskaya variety and 1286-1367  $\text{m}^{-2} \text{s}^{-1}$  at Vystavochnaya variety.

T,  $^{\circ}\text{C}$  – in the measurable room / of the leaf includes 23.4 / 28.08 for Noyabrskaya variety and 28.9/33.59 for Vystavochnaya variety.

Conductivity of the stomatas at  $\text{CO}_2$  including 0.03-0.04  $\text{mol m}^{-2} \text{s}^{-1}$  Noyabrskaya variety and 0.04- 0.17  $\text{mmol m}^{-2} \text{s}^{-1}$  Vystavochnaya variety.

The forth (21.07.2016), the fifth (12.08.2016) and the sixth (08.09.2016) measurements were done in the period of the end of vegetation period when the growth is much lower, and the process of storage in pear branches and roots started (donor).

The measurement 4, 5 and 6 are presented in table 5 made with LCi-4 in order to reflect the photosynthesis activity:

The intensity of photosynthesis for Noyabiscaya variety is 6.88 – 11.64  $\mu\text{mol m}^{-2} \text{s}^{-1}$  and for Vystavochnaya variety 1.61 – 6.07  $\mu\text{mol m}^{-2} \text{s}^{-1}$ .

The intensity of transpiration is 0.74 – 5.92  $\text{mmol m}^{-2} \text{s}^{-1}$  at Noyabrskaya variety and 0.92 – 4.43  $\text{mmol m}^{-2} \text{s}^{-1}$  at Vystavochnaya variety.

Photosynthetic active radiation is 780 - 1283  $\text{mmol m}^{-2} \text{s}^{-1}$  for Noyabrskaya variety and 1022 - 1191  $\text{mmol m}^{-2} \text{s}^{-1}$  for Vystavochnaya variety.

T,  $^{\circ}\text{C}$  – in the measurable room / of the leaf is 21.5/27.56 for Noyabrskaya variety and 21.1/27.29 for Vystavochnaya variety.

Conductivity of the stomatas at  $\text{CO}_2$  is 0.02 – 0.09  $\text{mmol m}^{-2} \text{s}^{-1}$  for Noyabrskaya variety and 0.02 – 0.08  $\text{mmol m}^{-2} \text{s}^{-1}$  for Vystavochnaya variety.

## CONCLUSIONS

1. The results of the researches showed that the intensity of the photosynthetic processes in the application of SBA *Verbascozida* 0.01% is much higher compared to the control variant.

2. *Verbascozida* growth regulator at a concentration of 0.01% significantly alters the intensity of photosynthetic processes and determines the ability to form and transport of assimilates.

3. At the end of the vegetation period, the intensity of processes of photosynthesis, transport and use of photosynthetic products in both variants is the same.

## REFERENCES

1. Chylyahyan M.H., 1982 - *Growth regulators and plant improvement*, M: IPP named by Timiryazev, p.303
2. Dushutina K. K., 1979 - *The pear selection*, Ed.Ch: p. 166; 168. (in russian)
3. Klimov S.V., 2008 - *Adaptation of plants to stresses through changing donor-acceptor relations at different levels of structural organization*. Advances in modern biology, vol. 128 (3), p. 128.(in russian)
4. Rabinovich E. 1953 - *Photosynthesis*.I V. 2, p. 287 (in russian)
5. Rubin B.A. 1970 - *Physiology of agricultural plants*. Ed. M: MSU, vol. IX. p.233. (in russian)
6. \*\*\*, BCI. 1994 - *Instruction for using the Lci - 4 Portable Photosynthesis System*, Ed. UK

## SOME BIOECOLOGICAL PARTICULARITIES AND FIGHTING AGAINST THE MAIN SPECIES OF PESTS IN THE PEAS CULTURE

### UNELE PARTICULARITĂȚI BIOECOLOGICE ȘI LUPTA ÎMPOTRIVA PRINCIPALELOR SPECII DĂUNĂTOARE ÎN CULTURA DE MAZĂRE

CROITORU N.<sup>1\*</sup>, PANUTA S.<sup>1</sup>, BODESCU C.<sup>2</sup>, LACATUSU Oana<sup>2</sup>

\*Corresponding author e-mail: n.croitoru@uasvm.md

***Abstract.** Increased productivity of pea crops is only possible through the use of intensive technologies, which involve the cultivation of potentially high yielding varieties and hybrids with increased resistance to harmful organisms, the improvement of integrated plant protection systems capable of providing large and stable crops. Integrated pest control requires the use of all prevention and prophylaxis, which involves rotation of crops, the use of healthy seeds, the correct application of soil work, the observance of the seasons and the depth of sowing, plant desiccation, weed control. A special place in the integrated protection system for canned peas is chemical products, the use of which is often inevitable.*

**Key words:** peas, pests, testing, insecticides

***Rezumat.** Creșterea productivității culturilor de mazăre este posibilă numai prin utilizarea tehnologiilor intensive, care implică cultivarea unor soiuri și hibrizi cu randament ridicat, cu o rezistență sporită la dăunători, îmbunătățirea sistemelor integrate de protecție a plantelor capabile să asigure culturi mari și stabile. Controlul integrat al dăunătorilor necesită utilizarea tuturor metodelor prevenirii și combaterii, ce implică rotația culturilor, utilizarea semințelor sănătoase, aplicarea corectă a lucrărilor solului, respectarea asolamentului și adâncimea de semănat, desicarea plantelor și controlul buruienilor. Un loc special în sistemul integrat de protecție pentru mazăre este produsul chimic, a cărui utilizare este adesea inevitabilă.*

**Cuvinte cheie:** mazăre, dăunători, teste, insecticide

## INTRODUCTION

Increased productivity of peas crops is possible only through the use of intensive technologies, which involve the cultivation of potentially high yielding varieties and hybrids with increased resistance to harmful organisms, the improvement of integrated plant protection systems capable of providing large and stable crops. Integrated pest control of peas requires the use of all prevention and prophylaxis possibilities, which involves rotation of crops, the use of healthy seeds, the correct application of soil work, respecting the season and the depth of

---

<sup>1</sup> Agrarian State University of Moldova, Republic of Moldova

<sup>2</sup> University of Agricultural Sciences and Veterinary Medicine from Iasi, Romania



sowing, plant breeding, weed control. A special place in the integrated system for preserving peas is covered by chemicals, the use of which is often inevitable.

The peas can be attacked by a wide range of pests, among the most dangerous were: the green pea of the peas - *Acyrtosiphon pisum* Harr., The pea trips - *Kakothrips robustus* Uzel, the striped ladybug - *Sitona lineatus* L. , the striped and hairy ladybug of the pea leaves - *Sitona crinitus* Hrbst, the pea beetle beetle - *Bruchus pisorum* L., the pea pod moth - *Cydia nigricana* Fabr., the peacock of the pea pods - *Cydia dorsana* Fabr.

The use of chemical treatments is allowed only when the economic damage threshold is reached, which makes 20-25 adults per 1 m<sup>2</sup>, and in dry years 10-15 individuals per 1 m<sup>2</sup> - for *Sitona* genus. For weevil peas beetle the economic threshold for damage is 150-200 adults per 100 mosquitoes with entomological mesh. The first chemical treatment occurs when the plantlets appear - against the *Sitona* genus. In the fight against pea beetle it is recommended to carry out 3 chemical treatments: first treatment - in the stage of picking - beginning of flowering; 2nd treatment takes place after flowering - beginning of fruit formation (20-25 eggs per 100 pods); 3rd treatment takes place at 10-14 days after the 2nd. In the beginning it is recommended the marginal treatment of the fields and when PED is exceeded, total treatments are made.

## MATERIAL AND METHOD

Scientific research on determining the biological effectiveness of Factor 250 WG has been completed in 2013. The experiments were carried out in the preserved peas field of the "Bubuieci" Agricultural Enterprise in Chisinau. The peas were sown in the first decade of April, with the 15 x 8-10 cm sowing scheme. Experiences were mounted in 4 rehearsals. The size of a plot was 10 x 10 m, and the area was 100 m<sup>2</sup>. The location of plots in the experimental group was compact, randomized. As a strip of isolation between the parcels, 1 m wide stripes were left. The surface of all parcels was 1600 m<sup>2</sup> and the total area was 1840 m<sup>2</sup>.

Experiences included four variants: Witness, untreated; Actara 25 WG standard, with consumption standard 0.1 kg / ha; Tiametoxam 250 WG preparation, with consumption standard - 0.08 kg / ha; Tiametoxam 250 WG preparation with consumption standard - 0.1 kg / ha.

In the process of selecting the batch for the installation of the experiments, the particularities of the development and hibernation of certain pest species were taken into account. The records for the purpose of determining the phytosanitary status were made by mowing the entomological mesh. Determination of the density of hibernating adults of weevil *Sitona* g. was made by recording them at 1 m<sup>2</sup> at the time of the emergence of the plantlets. For this, 16 surveys with the dimensions of 0.25 x 0.25 m were carried out on each plot. The pests were recorded before the treatment and on the 3rd, 7th and 14th day after treatment. The density of the green clover of peas, lamb beetles was made by making 100 mosquitoes with entomological mesh.

---

**RESULTS AND DISCUSSIONS**

At the beginning of the growing season of peas, in 2013, recordings were made that resulted in weevil from the genus *Sitona*, the numerical density of which was below the economic threshold of damage. In the second and third decades of May of the range of pests whose density exceeded the PED, there were green pea greens and pea seed beetles. Against these pests chemical treatment was done on May 13th. The results of the records and observations are shown in Table 1.

The results of the records until the treatment show that the numerical density of the green cow peas on the experimental lot was quite high. Recordings on the third day after treatment showed that no significant pest reduction was obtained in the experimental variants. In the 4th variant and the standard were found 2.03 and 2.54 specimens / 100 mosquitoes with the entomological mesh. In the third variant, 24.67 specimens / 100 mosquitoes were found, which exceeds the standard and the corresponding 4th variant of 9.71-12.15 times. Evidence, performed on seventh and fourteenth day after treatment, also demonstrated an essential difference between experimental and control variants. At the same time, the results of these records showed an increase of the numerical value of the pests in the 3rd variant, which is essentially different from the standard and the fourth variant.

The analysis of the density results, compared to the initial one, gave us the possibility to find out that on the 3rd day after treatment in all experimental variants remained living individuals from 1.28% - in the 4th variant, up to to 17.32% - in 3rd variant. This legality was also retained in the following 2 records. The difference between the experimental variants may be more prominent, comparing the results of the pest reduction to the control. This index comprised, on the 3rd day after treatment, from 84.11% - in the 3rd variant, to 98.82% - in the 4th variant. At 7 days after treatment, the pest density reduction of more than 90% was scored in the fourth and standard, where this index was 93.84-93.10%. At 14 days after treatment, the reduction in the numerical value of the pest was around 85.0% and made up 85.17% in the standard and 86.27% in the 4th variant. In third variant, this index accounted for 66.00%, which essentially deviates from the previous variants.

Based on the research and the results obtained, it was found that from all experimental variants the most effective is the Tiametoxam 250 WG insecticide, with a consumption standard of 0.1 kg / ha which ensures a significant reduction of the green pea of the peas, during 10-12 days and is at standard level. The same preparation with a consumption standard of 0.08 kg / ha, ensures a reduction of pest populations above 80.0% only in the first days after treatment. The results of the records before the flowering gave us the possibility to find out that besides the green puddings of the pea in the experimental group there were also found the adult pea lambs, the density of which comprised 15.95 to 17.25 individuals at 100 mosquitoes with entomological mesh. In connection with this, on June 4th, a second treatment directed to the control of adult pea beetle was carried out. The

record was made by mowing the entomological mesh. The results obtained and the calculation of the biological efficiency of the preparations are presented in Table 2.

Table 1

**Biological effectiveness of insecticide Factor 250 WG in combating green pea of peas**

Variant	Consumption of the norm of the preparation kg/ha	Numerical density of the pest in 100 moths with entomological mesh				Density of the pest, %, as compared to the original, at ... day after treatment			Reduction of pest density compared to control variant in% at ... day after treatment		
		Until treatment	at ... day after treatment			3	7	14	3	7	14
			3	7	14						
V <sub>1</sub> – Control	untreated	45.09	158.21	194.7	231.54	109.0	134.2	159.5	0.0	0.0	0.0
V <sub>2</sub> - Etalon, Actara 25 WG	0.1	154.26	2.54	13.11	27.19	1.65	8.50	17.63	98.49	93.10	85.17
V <sub>3</sub> - Tiametoxam 250 WG	0.08	142.37	24.67	45.12	68.02	17.32	31.69	47.78	84.11	74.25	66.00
V <sub>4</sub> - Tiametoxam 250 WG	0.1	157.98	2.03	11.98	25.78	1.28	7.58	16.32	98.82	93.84	86.27
DEM 05	-	-	1.96	2.07	2.13	2.65	2.89	3.15	1.81	2.18	2.33

The data presented in the table showed that the population of pups of pea beetle was fairly uniform. About this, testify the results of the records made before the treatment. At this time the pest density ranged from 15.95 in the third variant to 17.25 copies per 100 mosquitoes - in the 4th variant, thus exceeding the economic threshold of damage. The results of the records performed on the 3rd day after treatment showed that in all the variants treated there was an essential reduction of the numerical value of the pest and in the control variant this index increased by 3.28 individuals.

Comparing the experimental variants between them it is seen that the best results were obtained in the 4th and the standard where the adult density of pea beetles made 0.5 copies per 100 mosquitoes. In version 3, the number of live adults was 2.0 copies per 100 mosquitoes. The same legitimacy was also noted in the 7th and 14th day after treatment.

Comparing the number of living adults remaining in the variants treated with their initial value, it can be seen that even after this index the best results were received in the 4th variant and the standard (2.90, 3.03%), the deviation being insignificant. In the 3rd variant, this index constituted 15.54%, which is 7.75 times lower compared to the witness, but it yields the 4th variant and the standard, corresponding 5.35-5.12 times. The same trend was also highlighted as a result of the following 2 records.

A wider and more objective account of the biological efficacy of the preparations was obtained by analyzing the results of the reduction in adult pea

lamb density compared to the control. The results of the records, carried out on the 3rd day after treatment, showed that during this period in the 4th and the standard version this index constituted 97.59 and 99.85% accordingly, the deviation being nonessential. In third variant, the reduction in pest density is much lower (89.59%) and essentially yields to previous variants.

Table 2

**Biological Efficiency of Factor 250 WG Insecticide in Combating Pea Grass(2013)**

Variant	Consumption norm of the preparation kg / ha	Numerical density of the pest in 100 moths with entomological mesh	Density of the pest, %, as compared to the original, at ... day after treatment			Reduction of pest density compared to control variant in % at ... day after treatment					
			at ... day after treatment			3	7	14	3	7	14
			Until treatment	3	7						
V <sub>1</sub> – Control	untreated	6.00	19.28	21.16	25.34	120.5	132.25	158.38	0.0	0.0	0.0
V <sub>2</sub> - Etalon, Actara 25 WG	0.1	16.50	0.5	1.25	5.50	3.03	7.58	33.33	99.85	93.10	72.49
V <sub>3</sub> - Tiametoxam 250 WG	0.08	5.95	2.0	5.75	7.75	15.54	36.05	48.59	89.59	67.15	59.43
V <sub>4</sub> - Tiametoxam 250 WG	0.1	17.25	0.5	1.0	5.75	2.90	5.80	33.33	97.59	94.72	72.17
DEM 05	-	-	0.87	1.13	2.04	2.19	2.57	2.89	2.78	2.56	2.45

Evidence on the seventh day after treatment allowed us to note that even after this period, the reduction of the numerical value of adults in the treated variants was above 90%, ranging from 93.1% in the standard, up to 94.72% - in the 4th variant. In 3rd variant this index accounted for 67.15%.

On the 14th day after treatment, the reduction in pest density was 72.17% in the 4th variant and 72.49% in the standard. In 3rd version this index was below 60%.

Based on the researches carried out, during the 2013 growing season, it was found that the most effective in controlling the pests of preserved peas is the insecticide Tiametoxam 250 WG, with a consumption standard of 0.1 kg / ha, which ensures a pest reduction of 97.59 - 94.72%, during 7-10 days after treatment and is at the level of the standard. The same preparation, with a consumption standard of 0.08 kg / ha, essentially yields the previous version to the standard and provides protection for pea plants only within the first three days after treatment.

The weather conditions of 2013 have favored the development of the above-mentioned economic threshold for the green pea of peas and pea beetle pests.

Chemical treatment of pea plants with the insecticide Tiametoxam 250 WG at a dose of 0.1 kg / ha ensures a biological effectiveness of 98.82 - 93.84% in the

fight against green pea and 97.59 - 94.72% in the control of pea berries, 10-12 days after treatment.

The Tiametoxam 250 WG insecticide with a consumption standard of 0.08 kg / ha ensures satisfactory protection of pea culture only within the first days after treatment.

It is recommended to include the insecticide Tiametoxam 250 WG in the Integrated Pesticide Protection System by initiating a growth treatment to combat the green clover of the peas and a flowering treatment to control the pea beetle lamb with consumption standard 0.1 kg / ha.

## CONCLUSIONS

1. The weather conditions of 2013 have favored the development of the above-mentioned economic threshold for the green pea of peas and pea beetle pests.

2. Chemical treatment of pea plants with the insecticide Tiametoxam 250 WG at a dose of 0.1 kg / ha ensures a biological effectiveness of 98.82 - 93.84% in the fight against green pea and 97.59 - 94.72% in the control of pea berries, 10-12 days after treatment.

3. The Tiametoxam 250 WG insecticide with a consumption standard of 0.08 kg / ha ensures satisfactory protection of pea culture only within the first days after treatment.

4. It is recommended to include the insecticide Tiametoxam 250 WG in the Integrated Pesticide Protection System by initiating a growth treatment to combat the green clover of the peas and a flowering treatment to control the pea beetle lamb with consumption standard 0.1 kg / ha.

## REFERENCES

1. **Croitoru N., Timuș Asea, Panuța S., Gavdiuc, E., 2009** - *Eficacitatea unor produse cu conținut de Valsaciper 250 EC în combaterea dăunătorilor mazării pentru conservat.* Simpozionul științific internațional „Protecția Plantelor – Realizări și Perspective”, Chișinău, 1, p. 280-283.
2. **Timuș Asea, Croitoru N., Busuioac M., Panuța S., 2005** - *Îndrumar metodic pentru lucrările de laborator la disciplina „Prognoză și avertizare”* – pentru studenții anului IV, specialitatea 2804 - Protecția Plantelor. Universitatea Agrară de Stat din Moldova. Chișinău, 14, p. 62.
3. **Пануца С., Кройтору Н., Биологическая Эффективность Инсектицида, 2012** - *Triumph 250 EC в борьбе с основными вредителями на горохе.* „Protecția plantelor – probleme și perspective”, Chișinău, 1, p. 411-414.,
4. **Тимуш А., Кройтору Н., пануца С., 2010** - *О результатах испытания препарата Енгео К 247 SC против комплекса вредителей гороха, в условиях Республики Молдова.* 11, p. 25–27.
5. **\*\*\*, 2002** - *Îndrumări metodice pentru testarea produselor chimice și biologice de protecție a plantelor de dăunători, boli și buruieni,* Tipografia Centrală, Chișinău, , p.286.

## SOME ASPECTS REGARDING THE FIGHT AGAINST CEREALS BEETLE IN THE CONDITIONS OF THE REPUBLIC OF MOLDOVA

### UNELE ASPECTE PRIVIND LUPTA ÎMPOTRIVA DĂUNĂTORILOR DIN CULTURILE DE CEREALE ÎN CONDIȚILE REPUBLICII MOLDOVA

PANUTA S.<sup>1\*</sup>, CROITORU N.<sup>1</sup>, BODESCU C.<sup>2</sup>, LACATUSU Oana<sup>2</sup>

\*Corresponding author e-mail: s\_panuta@yahoo.com

**Abstract.** *Scientific research over several years has shown that the productivity of grain crops declines considerably both quantitatively and qualitatively under the influence of various harmful organisms, the population often outweighing the economic threshold of harm. Of the entire range of insect pest species, a special place and a primordial economic importance have the grubby beetle of grain. It is considered the most dangerous pest of autumn paws. Attacks numerous cultivated and spontaneous grasses, causing greater damage to wheat, barley, rye. It attacks both the adult and the larva, but produces particularly large damage to the larvae. Adults attack all the spinal organs. The biggest damage is caused by the larvae attacking the leaves, especially in the winter wheat, with a characteristic attack. They do not rotate the leaves, but chew them in the mouthpiece, extracting cellulite juice. The larval attack at first occurs in the form of winds, which gradually increase and encompass the entire culture. In large invasions, the sowing can be completely destroyed.*

**Key words:** wheat, pests, *Zabrus tenebrioides* Goeze, testing, insecticides

**Rezumat.** *Cercetarea științifică de-a lungul mai multor ani a demonstrat că productivitatea culturilor de cereale scade considerabil atât cantitativ cât și calitativ sub influența diferitelor organisme dăunătoare, populația depășind adesea pragul economic al dăunătorilor. Din întreaga gamă de specii de insecte dăunătoare, un loc special și o importanță economică primordială are gandacul ghebos al cerealelor. Acesta atacă numeroase ierburi cultivate și spontane, provocând daune mai mari grâului, orzului și la secară. Dăunătorul atacă atât adultul, cât și larva, dar produce daune deosebit de mari în stadiul de larvă. Adulții atacă toate organele plantei. Cele mai mari daune sunt cauzate de larvele care atacă frunzele, în special la grâul de toamnă, cu un atac caracteristic. Atacul larvelor apare la început sub forma de vetre, care cresc treptat și cuprind întreaga cultură. La invazii mari, răsărirea poate fi complet distrusă.*

**Cuvinte cheie:** grâu, dăunători, *Zabrus tenebrioides* Goeze, testare, insecticide

---

<sup>1</sup> State Agrarian University of Moldova, Republic of Moldova

<sup>2</sup> University of Agricultural Sciences and Veterinary Medicine from Iasi, Romania

## INTRODUCTION

The development and introduction of various intensive agricultural production technologies has positively influenced the significance and role of plant protection of diseases and weeds, which ensure that high yields are obtained. Scientific research over several years has shown that the productivity of grain crops declines considerably both quantitatively and qualitatively under the influence of various harmful organisms, the population often outweighing the economic threshold of harm.

Of the entire range of insect pest species, a special place and a primordial economic importance have the grubby beetle of grain. It is considered the most dangerous pest of autumn paws. Attacks numerous cultivated and spontaneous grasses, causing greater damage to wheat, barley, rye. It attacks both the adult and the larvae, but produces particularly large damage at a larvae.

Chemical combat of the grubby beetle can be achieved by applying seed and plant treatments. Seed treatment is applied before sowing when the numerical density of females exceeds  $0.5 \text{ ex./m}^2$  and larvae  $2 \text{ ex./m}^2$ .

Chemical treatments against larvae are carried out according to climatic conditions, plant development phase, plant and larva density. At the occurrence of the plants, in the phase of 1-2 leaves, at an optimal level ( $450\text{-}600 \text{ plants/m}^2$ ) chemical treatments apply when the larval density exceeds PED ( $2 \text{ larvae/m}^2$ ) and in dry time at  $1.0 \text{ larvae/m}^2$ ; in rare crops ( $250\text{-}300 \text{ plants/m}^2$ ) chemical treatments are applied at  $0.5\text{-}0.7 \text{ larvae/m}^2$ . In the third leaf-twinning phase, chemical treatments are applied in outbreaks when PED is exceeded ( $2\text{-}3 \text{ larvae /m}^2$ ), and if the larvae have a diffuse spread, the treatments apply to  $3\text{-}4 \text{ larvae/m}^2$ .

## MATERIAL AND METHOD

The experience was assembled on fields with autumn wheat in "VALENAGRO COM" in Ciutulești village, Floresti district. The crop was sown in the second half of September 2015, with the space between narrow rows. In selecting the appropriate batch for experiments, we considered the methodical requirements for insecticide research, which imply a pest density of 3-4 specimens per  $1 \text{ m}^2$ . The experience included 4 variants: blank, untreated; standard - Superkill 440 EC insecticide, with consumption standard  $1.0\text{L/ha}$ ; preparation CHC/53-I EC, with consumption standard -  $1.0\text{L/ha}$ ; preparation CHC/53-I EC, with consumption standard -  $1.2\text{L/ha}$ .

The experience was mounted in 4 rehearsals. The dimensions of a plot were  $10\text{m}\times 10 \text{ m}$ , so the area of  $100 \text{ m}^2$ . Between the parcels a strip of insulation with a width of  $1 \text{ m}$  was left. The area of the parcels was  $1600 \text{ m}^2$  and the total area including the insulation strips was  $1720 \text{ m}^2$ . The location of the plots was compact randomized.

## RESULTS AND DISCUSSIONS

Recordings on wheat fields for the purpose of launching experiments began on 1 April. In order to correctly determine the start-up period, account was taken of the fact that, in combating the grubby beetle, the effectiveness of insecticides is much higher if they are used against larvae of age 1-2, which are more sensitive. Therefore, efforts have been made in the spring records to determine the age of larvae of the cereal beetle. The results obtained in Table 1 show that 9.5 larvae per 1 m<sup>2</sup> were found in the parcels on 1 April, of which 7.0 were 73.68% larvae age 2 and only 2.5 copies/ m<sup>2</sup> or 26.32% were larvae at the age of 3.

Records made on April 15 gave us the opportunity to track the development of the grubby beetle. It was found that the larval density was increased by 4 specimens in 8 polls, constituting 23 copies. Analyzing the evolution of the larval stage, it is seen that within 14 days of the total number of larvae, 6.0 ex/m<sup>2</sup>, representing 52.17%, were 2 years of age and 5.5 ex/ m<sup>2</sup>, or 47.83% passed age 3.

Table 1

### Evidence of the development of the grubby beetle in the spring, 2016

Period	Number of pests										
	Total		of these							Pupae	
			Larvae								
	ex./8 sond.    ex./m <sup>2</sup>		Including stage a					ex./m <sup>2</sup> %			
			II			III					
ex./8 sond.	ex./m <sup>2</sup>	ex./8 sond.	ex./m <sup>2</sup>	%	ex./8 sond.	ex./m <sup>2</sup>	%	ex./m <sup>2</sup>	%		
1.04.16	19.0	9.5	14	7.0	73.68	5	2.5	26.32	0.0	0.0	
15.04.16	23.0	11.5	12	6.0	52.17	11	5.5	47.83	0.0	0.0	

Based on the evidence, it was found that in the first and second decades of April, the grubby beetle is active, being in the larval stage of age II and III. In favor of this conclusion are also the freshly attacked plants. So setting up experiences during spring is rational.

As noted above in the first and second decades of April, most of the grub beetle larvae were aged 2 and 3, were very active and resumed their nutrition. As a testimony to this conclusion, it serves in crops, alongside healthy plants and freshly attacked plants. In connection with this, it was considered rational to set up the experiences related to the determination of the biological effectiveness of the CHC/53-I EC insecticide in combating cereal beetle larvae in autumn wheat cultures. That's why chemical treatment was done on April 14th. In order to determine the biological efficacy of the preparations, the numerical density of the larvae in the soil and the attack of



the plants on the treated sectors were compared, as compared to the untreated ones.

It can be seen from the table that the numerical density of larvae before treatment in the experimental group was quite uniform and varied from 3.75 ex./m<sup>2</sup> in variant 3 to 5.00 ex./ m<sup>2</sup> - in the 4th and in the blank. Evidence on the third day after treatment gave us the possibility to find that the larvae of the cereal beetle beetle were found in all experimental variants but the lowest value was scored in the 4th variant (0.25 ex./m<sup>2</sup>) and in the standard (0.50 ex./m<sup>2</sup>), the deviations between them being nonessential.

In 3rd variant this index was 0.75 ex/ m<sup>2</sup>, which is 1.5 and 3.0 times higher than in the standard and the 4th variant. In the control variant, the larvae density has been prolonged and increased during this period of 5.25 ex/m<sup>2</sup>, which essentially exceeds all experimental variants. Evidence on the seventh day after treatment showed that the lowest density of the larvae of the cereal grubby beetle was marked in the 4th variant and in the standard, comparing respectively 0.50 and 0.75 ex./m<sup>2</sup>.

In order to record the numerical density of the larvae, soil surveys were conducted. For this, four samples were placed in the center of each plot, placed in 2 rows, with a size of 0.25 m<sup>2</sup>, 50x50 cm, and a depth of 20-25 cm. Soil polls were put on a film and thoroughly scrutinized. Parallel with the evidence of larvae of the grueling beetle beetle, there was also evidence of worms, false snakes, saplings, and other insect species. Recordings were made until treatment at the 3rd, 7th, and 14th days after the treatments. The results of the research are shown in Table 2.

Table 2

**Biological Efficacy of CHC / 53-I EC Insecticide in Combating Grubby Beetle Larvae (Springtime Experiments, 2016)**

No	Variants	Consumption norm L/ha	Density of larvae, ex./m <sup>2</sup>				Reduction of larval density relative to control in %% at ..... day after treatment		
			Until treated	on day 3 after treatment	on day 7 after treatment	on day 14 after treatment	3	7	14
1.	Control	untreated	5.00	5.25	5.50	5.50	0.0	0.0	0,0
2.	Etalon, Superkill 440 EC	1.0	4.50	0.50	0.75	1.50	90.48	86.36	72.73
3.	CHC/53-I EC	1.0	3.75	0.75	1.00	1.75	85.00	81.00	68.00
4.	CHC/53-I EC	1.2	5.00	0.25	0.50	0.75	95.00	91.00	86.00
DEM P 5%				0.31	0.43	0.67	4.98	5.47	4.65

In 3rd variant this index was 1.00 ex./m<sup>2</sup>. The statistical processing of the results showed that between the third and the standard deviations the deviations are not essential, and in the 4th version this index constituted 0.50 ex/m<sup>2</sup> and is at the level of the standard. In the blank version this index constituted 5.5 ex/m<sup>2</sup>.

In the 14 days after treatment, it was found that the lowest density of the larvae of the cereal grubby beetle was reached in the 4th variant and in the standard, where this index constituted 0.75 and 1 respectively, 50 ex / m<sup>2</sup>. In the control, the larval density was maintained at the level of the 7th day after treatment (5.5 ex / m<sup>2</sup>). The statistical processing of the experimental results showed that only between the 4th and the standard deviations are nonessential.

The calculation of the larvae density reduction of the cereal beetle compared with the control shows that on the 3rd day after treatment in the 4th and the standard version this index exceeded more than 90%, corresponding to 95.00 and 90.48%. In 3rd variant, this index accounted for 85.00% and essentially yields both the fourth and the standard.

On the 7th day after treatment, the highest reduction was also reached in the 4th and the standard, respectively, representing 91.00 and 86.36%. In 3rd variant this index reached only 81.00%. The statistical processing of the results has shown that deviations are essential, only between the 3rd variant and the standard. The 4th variant essentially exceeds both the 3rd and the standard. The results received on the 14th day after treatment testify to the fact that only in the 4th variant the reduction of the larval density reached the value above 80.00%, making up 86.00% which essentially exceeds both the standard (72.73 %) and the third variant. In 3rd variant, this index reached only 68.00% and yielded essentially to the 4th and the standard.

Simultaneously with the evidence of larvae, in the experimental group, the evidence of attacked plants was also made. The attack level of the plants was determined by counting the healthy ones and those attacked on a part of the row with a total length of 5 m. For this plot, 10 samples of 0.5 m were taken. in the same days when the larvae records went.

Taking into account the fact that the experience was assembled in the spring, during the recording, the plants were divided into two groups: freshly attacked plants; plants attacked autumn (old). The results obtained are shown in Table 3. It can be seen from the table that the total number of plants at 5 m linear lines consisted of 128.50 plants - in the 3rd variant, up to 133,25 - in the variant a 4th.

The total number of plants at 1m linear ranged from 25.70 in the 3rd variant to 26.65 in the 4th variant. Density of healthy plants ranged from 57.25 to 5 m linear - in the control variant to 76.00 plants in the 4th variant. The same legality was marked in healthy plant counts at 1 m linear. The smallest number of plants attacked at 5 m linear was marked in variant 4 (57.25) and in variant 3 (64.75).

It is known that the main criterion is the presence of freshly attacked plants demonstrating also the presence of the larvae of the grueling beetle of the cereal.

Evidence in the experimental group gave us the possibility to find that the lowest number of freshly attacked at 5 m linear plants was scored in the 4th (4.00) and the 5.00th version. The ratio of freshly attacked plants at 1 m linear was 0.80 in the 4th and 1.0 in the standard.

The calculation of the density reduction of freshly attacked plants relative to the control gave us the possibility to find that the highest index was reached in the 4th variant and in the standard, corresponding to 85.19 and 81.00%. In third variant, the reduction of the attacked plants was 79.00% and this index is at the level of the standard.

Based on the researches carried out and the results obtained it can be ascertained that the best results were received in the 4th variant, where the reduction of the beetle larvae was 95.00 - 91.00% and the reduction of the attacked plants reached 85.19% and essentially exceeds the benchmark. The 3rd variant yields the 4th variant and is at the level of the standard.

It is well known that in the fight against the larvae of the grubby beetle larvae, the more effective treatments are the autumn, against larvae of age I and II because they are more sensitive. That's why research on plant protection products has been repeated and autumn. Experiences were installed in the fields of Cazangic, Leova district.

In autumn wheat was sown in the second decade of October. For the record of larvae, soil surveys were carried out with a surface of 0.25 m<sup>2</sup> and a depth of 20-25 cm diagonally in 10 places. The chemical treatment of parcels in the experimental group was completed on November 12, 2016. The larval density in the experimental group was determined by conducting 4 polls at the center of each plot, in the plant phase. The data of Table 4 testify to the fact that the larvae density of the beetle beetle before the treatment was quite uniform and ranged from 3.50 ex / m<sup>2</sup> in the control variant to 4.50 ex / m<sup>2</sup> in the 4th variant.

The evidence on the third day after treatment showed that in the 4th variant the larvae of the cereal beetle were not found, and in the third and the standard version, this index constituted 0.25 ex / m<sup>2</sup>.

The 7th day after treatment showed that the pest was detected in all experimental variants, but the lowest density was scored in the 4th variant. The same legality was also marked on the 14th day after treatment.

The calculation of the reduction in larval density in relation to the control showed that only in the 4th variant a 100% reduction was achieved on the 3rd day after treatment. In the third and the third version this index constituted 94.44%.

On the seventh day after treatment in all variants, the reduction constituted more than 90%, but the 4th variant essentially exceeded both the third and the standard. The same trend was marked on the 14th day after treatment.

Based on the researches carried out in the autumn and the results obtained, it can be seen that the best indices were received in the 4th variant, where the reduction of the larvae of the beetle made 100.0-95.65%, which exceeds the standard. The 3rd variant yields the 4th variant and is at the level of the standard.

Table 3

**The results of the reduction of the plants attacked by the grubby beetle larvae in the experimental group for testing the CHC / 53-I EC insecticide (Spring, 2016)**

Variants	Consumption norm l/ha	Number of plants										Reducing Density of plants attacked against the control %
		total		of these								
		la 5 m liniars	la 1 m liniars	healthy		attacked						
				la 5 m liniars	la 1 m liniars	total		inclusive				
		la 5 m liniars	la 1 m liniars			la 5 m liniars	la 1 m liniars	freshly attacked	attacked in autumn			
la 5 m liniars	la 1 m liniars			la 5 m liniars	la 1 m liniars							
Control	untreated	129.00	25.80	57.25	11.45	71.75	14.35	27.00	5.40	44.75	9.95	0.0
Etalon, Superkill 440 EC	1.0	131.75	26.35	65.50	13.10	66.25	13.25	5.00	1.00	61.25	15.25	81.00
CHC/53-I EC	1.0	128.50	25.70	67.5	12.75	64.75	12.96	5.50	1.10	59.25	11.85	79.00
CHC/53-I EC	1.2	133.25	26.65	76.00	15.20	57.25	11.45	4.00	0.80	53.25	10.65	85.19
DEMP 5%		-	-	-	-	-	-	-	-	-	-	2.93

Table 4

**Biological Efficiency of CHC / 53-I EC Insecticide in Combating Beetle Larva in Cereals (Autumn, 2016)**

No	Variants	Consumption norm L/ha	Density of larvae, ex./m <sup>2</sup>				Reduction of larval density relative to control in % at ..... day after treatment		
			Until treated	on day 3 after treatment	Until treated	on day 3 after treatment	Until treated		
							3	7	14
1.	Control	untreated	3.50	4.50	5.75	6.50	0.0	0.0	0.0
2.	Etalon, Superkill 440 EC	1.0	3.75	0.25	0.50	1.25	94.44	91.30	80.77
3.	CHC/53-I EC	1.0	4.00	0.25	0.50	1.00	94.44	91.30	84.62
4.	CHC/53-I EC	1.2	4.50	0.00	0.25	0.50	100.0	95.65	92.31
DEMP 5%		-	-	-	-	-	4.94	4.07	5.27

## CONCLUSIONS

1. The climatic conditions of the spring and autumn of 2016 have positively influenced the development of the larval stage of the grubby beetle.

2. In the 2nd and 3rd decades of April and autumn in November, favorable conditions were created for carrying out chemical treatments and determining the biological effectiveness of insecticides.

3. The CHC / 53-I EC preparation, with a 1.0 L/ha consumption standard, provides an efficacy in combating the galloping beetle at the standard level.

4. The most effective in combating larvae of the cereal chick beetle is the CHC / 53-I EC insecticide with a consumption standard of 1.2 L/ha, which provides an efficacy of 95.00 - 91.00% and 100.0 - 95.65%.

5. Based on the above, the CHC/53-I EC insecticide at a dose of 1.0-1.2 L/ha can be included in the integrated wheat beetroot protection system.

## REFERENCES

1. Croitoru N., Timuș Asea, Panuța S., Gavdiuc E., 2009 - *Eficacitatea unor produse cu conținut de Valsaciper 250 EC în combaterea dăunătorilor mazării pentru conservat.*, „Protecția Plantelor – Realizări și Perspective”, Chișinău, 1, p. 280-283.
2. Timuș Asea, Croitoru N., Busuioc M., Panuța S., 2005 - *Îndrumar metodic pentru lucrările de laborator la disciplina „Prognoză și avertizare” – pentru studenții anului IV, specialitatea 2804 - Protecția Plantelor.* Universitatea Agrară de Stat din Moldova. Chișinău, 14, p.62.
3. Кройтору Н., Пануца С., Тимуш Ася. *Эффективность новых препаратов против комплекса вредителей гороха*, *Lucrări științifice, UASM. Chișinău*, 24, p. 411-417.
4. Пануца С., Кройтору Н. *Биологическая Эффективность Инсектицида, 2012 - Triumph 250 EC в борьбе с основными вредителями на горохе.* „Protecția plantelor – probleme și perspective”, Chișinău, 1, p. 411-414.,
5. Тимуш А., Кройтору Н., Пануца С., 2010 - *О результатах испытания препарата Engeo K 247 SC против комплекса вредителей гороха, в условиях Республики Молдова. В: Материалы Международной научно-практической конференции, посвященной 65-летию кафедры защиты растений «Актуальные проблемы в защите растений», Горки, 23-25 июня, p. 25–27.*
6. \*\*\*\* 2002 - *Îndrumări metodice pentru testarea produselor chimice și biologice de protecție a plantelor de dăunători, boli și buruieni în Republica Moldova.* Tipografia Centrală, Chișinău

## PARASITOID WASPS AND THEIR INFLUENCE ON FOREST PEST POPULATIONS

### VIESPI PARAZITOIDE ȘI INFLUENȚA LOR ASUPRA POPULAȚIILOR DE DĂUNĂTORI FORESTIERI

PEI Gheorghe<sup>1</sup>, BRUDEA Valentin<sup>2</sup>

\*Corresponding author e-mail: pey\_gheorghe@yahoo.com

**Abstract.** Parasitoid wasps are very important in reducing populations of little spruce sawfly (*Pristiphora abietina* Christ.), yearly percent of affected cocoons being between 23 and 35,2%. In laboratory conditions, 23% from the monitored cocoons was affected by parasitoid wasps, the largest share being owned by ichneumonids (19%). Was identified 2 new species of ichneumonids for Romania fauna (*Mesoleius ruficollis* Holmgren and *Ctenochira flavicauda* Roman). It is necessary to be made researches in this domain, to know better the parasitoid complex and the significant importance in pest control and the protective measures which must be adopted by the forest management.

**Key words:** parasitoid, little spruce sawfly, ichneumonids.

**Rezumat.** Viespile parazitoide joacă un rol important în reducerea populațiilor viespii mici cu fierăstrău a acelor de molid (*Pristiphora abietina* Christ.) procentul anual de parazitare al coconilor variind între 23 și 35,2%. În condiții de laborator, 23% dintre coconii monitorizați au fost parazitați, ponderea cea mai mare fiind deținută de ichneumonidae (19%). Au fost identificate 2 specii noi de ichneumonidae pentru fauna României (*Mesoleius ruficollis* Hlgh. și *Ctenochira flavicaudata* Rom.). Sunt necesare cercetări cu privire la importanța și influența parazitoizilor asupra populațiilor de dăunători forestieri precum și a măsurilor de protecție a acestora ce trebuie adoptate de managementul forestier.

**Cuvinte cheie:** parazitoid, viespea mică cu fierăstrău a acelor de molid, ichneumonidae

## INTRODUCTION

Parasitoid wasps play a very important role to keep under control the insects which produce damages in the forest and are one of the most important biotic limitative factor (Ceianu *et al*, 1965; Pisciă, 1980; Brudea, 2007). Knowing of this species is very important for the forest ecosystems management and theirs protection. The necessity of studies regarding the parasitoid contributions to the reduction of forest pest level is represented by the fact that in many cases, predicted damages was under estimated level, which reinforces the hypothesis that the activity of mortality factors is very high, among them being also and parasitoid insects (Mráček, 1994; Ceianu *et al* 1965, Brudea & Pei 2006).

<sup>1</sup>Faculty of Silviculture and Forest Engineering, Transilvania University of Brasov, Romania

<sup>2</sup> Forestry Faculty, "Ștefan cel Mare" University of Suceava, Romania

## MATERIAL AND METHOD

As a case study for the activity of parasitoid wasps and the influence on pest populations, pupa (cocoon) stage of little spruce sawfly *Pristiphora abietina* Christ. (O. Hymenoptera, F. Tenthredinidae) was chosen.

The research has been carried out in the Eastern Carpathians, in the group of Stâniș oara Mountains, Suceava county, Boroaia administrative unit, forest management unit Fălticeni, on a surface of 856,70 ha, for a period of three years.

To collect cocoons, 32 soil samples/year were taken (25/25/10 centimeters) from the spruce/mixed forest (proportion of spruce over 50%), where the little spruce sawfly *Pristiphora abietina* Christ. was present. Sorting of the cocoons was made according with specific exit orifices (Stănescu, 1962; Ceianu, 1965) (tab. 1) (fig. 1).

Table 1

Elements used to sort the cocoons affected by parasitoids (Stănescu, 1962)

Particularity of the specific exit orifices	Probable cause
Cocoons with a small, round orifice	Ichneumonidae
Cocoons with several small, round orifices	Chalcidoidea
Cocoons with very shiny internal walls	Diptera

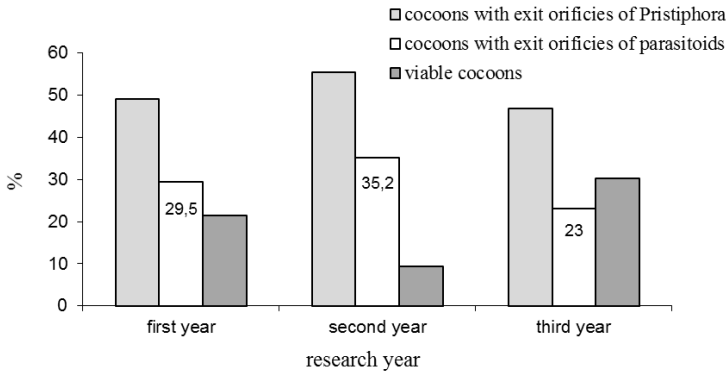
For the observations regarding the exit of the insects from the cocoons (*Pristiphora abietina* Christ. and parasitoids), 50 of healthy cocoons was selected and monitored in laboratory conditions. The parasitoid wasps was identified by Prof. Dr. Ionel Andreiescu and Prof. Dr. Constantin Pisciă (†) ("AL. I. Cuza" University, Iași).



Fig. 1 Specific exit orifices

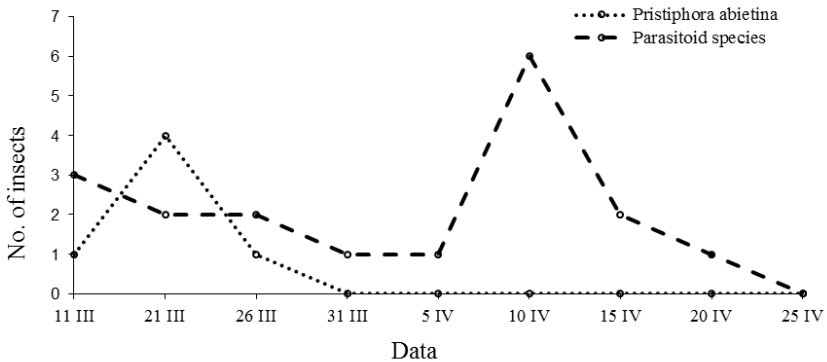
## RESULTS AND DISCUSSIONS

After analyzing collected cocoons which were presenting specific leaving orifices by the parasitoid wasps, parasitization ratios of 29.5% (first year), 35.2% (second year) and 23% (third year) (fig. 2) were observed.



**Fig. 2** Proportion of cocoons (*Pristiphora abietina* Christ.) affected by parasitoids

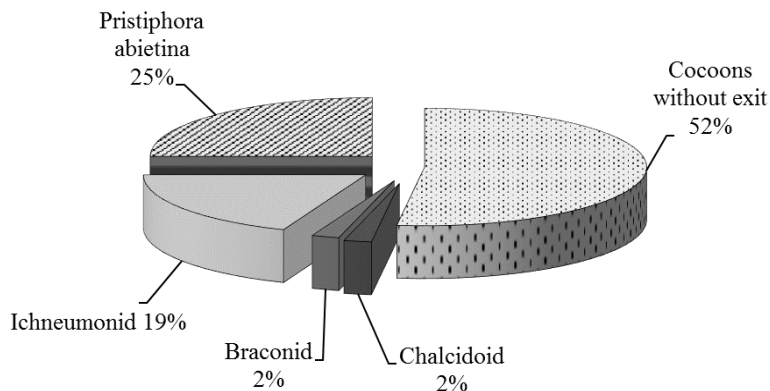
For the cocoons monitored in laboratory conditions, hatching of the parasitoids occurred for a longer period than the adults of *Pristiphora abietina* Christ. (fig. 3), maximum having place in the first decade of April. Even that the observations was made in the laboratory conditions, was possible to identify the moment of the hatching for the main parasitoid wasps in comparison with little spruce sawfly adults.



**Fig. 3** Dynamic of the hatching from cocoons for adult insects (laboratory conditions)

Our research showed that the presence of parasitoid wasps in the cocoons was in proportion of 23%. Of this proportion, 2% were chalcidoids, 2% braconids and 19% ichneumonids (fig. 4).





**Fig. 4** Main parasitoids wasps obtained (laboratory conditions)

**Chalcidoids wasps:** was obtained a species of genus *Tritneptis* (fig. 5);, Suprafamily *Chalcidoidea*, Family *Pteromalidae*, that was represented by 6 females, 1 male and 1 larva. At the moment of the study this species don't was identified because are missing recent reviews, the key for identification used in Europe is from 1969, contains only three species of the genus, obtained species does not fit into them.



**Fig. 5** Chalcidoid wasps – *Tritneptis* sp.

**Braconid wasps:** has been identified just de family, at the moment of the study don't was identified the species.

**Ichneumonid wasps:** a total of 8 species were identified, from 5 subfamilies (*Banchinae*, *Cryptinae*, *Ctenopelmatinae*, *Mesochorinae* and *Tryphoninae*) (tab. 2). The species *Mesoleius ruficollis* Hlgh. and *Ctenochira*

*flavicauda* Rom. are new in Romania. *Pristophora abietina* Christ. is the new host species in Romania for species: *Agrothereutes abbreviatus* F., *Mesoleius ruficollis* Hlgr. *Lissonota folii* Thoms., *Endasys analis* Thoms., *Endasys brevis* Grav., *Endasys testaceus* Taschb., *Mesochorus brevipetiolatus* Ratzb. and *Ctenochira flavicauda* Rom.

Table 2

Ichneumonid wasps obtained from *Pristophora abietina* Christ. cocoons

Family	Subfamily	Species
Ichneumonidae	Banchinae	<i>Lissonota folii</i> Thomson
	Cryptinae	<i>Agrothereutes abbreviatus</i> Fabricius
		<i>Endasys analis</i> Thomson
		<i>Endasys testaceus</i> Taschenberg
		<i>Endasys brevis</i> Gravenhorst
	Ctenopelmatinae	<i>Mesoleius ruficollis</i> Holmgren
	Meschorinae	<i>Mesochorus brevipetiolatus</i> Ratzeburg
Tryphoninae	<i>Ctenochira flavicauda</i> Roman	

## CONCLUSIONS

1. The proportion of *Pristiphora abietina* Christ. cocoons which was affected by parasitoid wasps was between 23% and 35,2% per year, what it proves an intense activity of the parasitoids.

2. Maximum level of the parasitoids adults hatching is registered at 20 days after maximum level of the *Pristiphora abietina* Christ. (laboratory conditions).

3. The most important parasitoid wasps are represented by ichneumonids (19%).

4. Was identified 8 species of ichneumonids, 2 species are new to Romania fauna (*Mesoleius ruficollis* Holmgren and *Ctenochira flavicauda* Roman).

5. It is necessary to be made researches in this domain, to know better the parasitoid complex and the significant role in pest control.

6. Forest management must take in consideration the protection of parasitoid insects populations and the importance of biodiversity (mixed forest, areas with grass vegetation, floral trees, grazing ban).

## REFERENCES

1. Brudea V., 2007 – *Combaterea biologică în Managementul Integrat la Insectelor Dăunătoare, cu referire special la ecosistemele silvice*. Editura Universității Suceava, p. 240.
2. Brudea V., Pei G., 2006 – *Bioecology and control researches concerning the little spruce sawfly *Pristiphora abietina* Christ (Hymenoptera: Thentredinidae)*. Analele

Științifice ale Universității "AL. I. Cuza" Iași, secțiunea Biologie Animală, Tom LII, p. 131-136.

3. **Brudea V., Pei G., 2006** – *Viespea acelor de molid*. Revista Sănătatea Plantelor, p. 41.
4. **Ceianu I., Mihalache Gh., Balinschi I., 1965** - *Combaterea biologică a dăunătorilor forestieri*. Editura Agrosilvică, București, p. 225.
5. **Mráček Z., 1994** - *Steinernematids and their natural web-spinning sawfly hosts in forest ecosystems – a historical outline*. Institute of Entomology, Branišovská, p. 50.
6. **Pisică C., Brudea V., 2011** – *Speciile de ichneumonide (Hym., Ichneum.) care parazitează viespea acelor de molid *Pristiphora abietina* (Christ) (Hym. Tenthredinidae) în nord-estul României*. Volumul de lucrări al simpozionului "Biodiversitatea și managementul insectelor din România", Editura Universității "Ștefan cel Mare" Suceava, p. 137-141.
7. **Olenici N., 2005** - *Pristiphora abietina* (Christ) (Hymenoptera, Tenthredinidae) - *un dăunător important al molidului din afara arealului natural de vegetație*. Revista Pădurilor, Anul 120, Nr. 1, p. 3-12.

## OBSERVATIONS REGARDING MULTIPLICATION ON VEGETATIVE WAY OF *BUXUS SEMPERVIRENS* L. SPECIES IN IAȘI COUNTY CONDITIONS

OBSERVAȚII PRIVIND ÎNMULȚIREA PE CALE VEGETATIVĂ A  
SPECIEI *BUXUS SEMPERVIRENS* L. ÎN CONDIȚIILE JUDEȚULUI IAȘI

**BERNARDIS R.<sup>1</sup>, CHELARIU ELENA LILIANA<sup>1</sup>, DASCĂLU M<sup>1</sup>.,  
ZLATI CRISTINA<sup>1</sup>, PAȘCU ROXANA<sup>\*</sup>, POȘTA DANIELA<sup>2</sup>**

<sup>\*</sup>Corresponding author e-mail: ing.dr.roxana@gmail.com

**Abstract.** *Within the multitude of dendrological species, Buxus species are particular importance in green areas and especially in our country's conditions that are generally favorable and very favorable to these species. The aim of the paper is to highlight the potential for vegetative propagation of the most popular species, namely Buxus sempervirens L., which is found in Iasi county. During the vegetation period, observations were made on the action of rooting biostimulators and the growth rate of cuttings roots by determining the percentage of rooted cuttings, the average length of roots emitted per cuttings and the average number of roots per cut.*

**Key words:** seedlings, substrate, rooting bio-stimulators.

**Rezumat.** *În cadrul multitudinii de specii dendrologice, speciile genului Buxus au o importanță deosebită în amenajarea spațiilor verzi și mai ales în condițiile de la noi din țară care sunt în general favorabile și foarte favorabile pentru aceste specii. Scopul lucrării este de a pune în evidență potențialul de înmulțire pe cale vegetativă a celei mai cunoscute specii, respectiv Buxus sempervirens L., care se întâlnește în județul Iași. Pe parcursul perioadei de vegetație s-au efectuat observații privind acțiunea biostimulatorilor de înrădăcinare și sporul de creștere al rădăcinilor butașilor prin determinări privind procentul de butași înrădăcinați, lungimea medie a rădăcinilor emise pe butași și numărul mediu de rădăcini pe butaș.*

**Cuvinte cheie:** butași, substrat, biostimulatori de înrădăcinare

### INTRODUCTION

One of the basic components of the green spaces that ensures the aesthetic appearance of the localities is the landscaping.

Within the multitude of dendrological species of ornamental shrubs, Buxus species are of particular importance in green areas, and the conditions in our country that are generally favorable and very favorable to this species.

---

<sup>1</sup>University of Agricultural Sciences and Veterinary Medicine from Iași, Romania

<sup>2</sup>University of Agricultural Sciences and Veterinary Medicine of Banat Timisoara, Romania

The necessity of diversifying the assortment is a priority given the diversity of biological material and especially the achievements achieved worldwide. This work is complemented by specialists in the field as an efficient and well documented material because it follows the percentage of rooting in *Buxus sempervirens* L. under unprotected conditions (Bernardis, 2010, Iliescu, 2002).

## MATERIAL AND METHOD

The production of the rooted cuttings of *Buxus sempervirens* L. took place in the Tudor Neculai nursery in Iași in 2017. The knock-off period and the arrangement on rooting substrates was carried out in April. The time interval was two months (april, may).

The biological material used consists of semi-milled cuttings from spiked peaks, with an average length of 6-8 cm that have been degraded in the basal part on a segment of 4 centimeters. The cuttings were harvested from healthy plants from the Tudor Neculai nursery collection in Iași. The harvesting, preparation and placement of the cuttings on the rooting substrate took place on the same day.

The experience is of type 3x2, in two repetitions:

-Factor A - the type of rooting substrate with three graduations: a1- Prut sand; a2-Prut sand + forest vegetation (1: 1); a3-pearlite granules + sand (1: 1);

- Factor B - treatment with rhizogenic bio-stimulators (Radi-Stim No 2): b1-treated; b2-untreated.

By combining factor A with factor B and graduations, 6 experimental variants resulted (tab. 1). These variants were based on the subdivided plot method.

The substrates prepared for the experiments were placed on a layer 15 cm thick uniformly. Twenty cuttings were prepared and seated for each intentional experimental variation.

Table 1

**Experimental variants of rooted cuttings *Buxus sempervirens* L.**

Varariant	Var. symbol	Type of substrate/type of cuttings
V <sub>1</sub>	a <sub>1</sub> b <sub>1</sub>	Prut sand, untreated cuttings
V <sub>2</sub>	a <sub>1</sub> b <sub>2</sub>	Prut sand, treated cuttings
V <sub>3</sub>	a <sub>2</sub> b <sub>1</sub>	Pearlite granules + sand (1:1), untreated cuttings
V <sub>4</sub>	a <sub>2</sub> b <sub>2</sub>	Pearlite granules + sand (1:1), treated cuttings
V <sub>5</sub>	a <sub>3</sub> b <sub>1</sub>	Black earth + sand (1:1), untreated cuttings
V <sub>6</sub>	a <sub>3</sub> b <sub>2</sub>	Black earth + sand (1:1), treated cuttings

Measurements and determinations have been made regarding the percentage of rooted cuttings (the number of rooted cuttings from the total of those planted on variants); the average length of roots emitted per cuttings and the average number of roots per cut.

To determine the average root length of the cuttings, measurements were made for each individual root and their amount was reported as the number of roots.

With these measurements, the parameters related to the evolution of the growth of the root system of the cuttings, the importance of the rooting biostimulators on the rooting efficiency and the growth rate of the roots of the cuttings were calculated.

## RESULTS AND DISCUSSIONS

In Romania, *Buxus sempervirens* L. are found in most nurseries, having an ornamental, therapeutic and environmental value (Mihail, 2005). An extremely valuable method for production is the multiplication of the species by vegetative way through cuttings. The results obtained at the end of the rooting period of cuttings of *Buxus sempervirens* L., untreated and treated with rhizogenic bio-stimulator, on various rooting substrates were reported in table 2 and table 3 and the primary data were statistically transformed and interpreted. Risogenesis is the phenomenon of organogenesis with a major implication in vegetative multiplication, because in its study a complex of factors that interact must be considered.

Table 2

**Experimental results on the rooting of untreated cuttings  
by *Buxus sempervirens* L. under the influence of substrate composition**

Substrate type	Rooted cuttings (%)
	b <sub>1</sub> — untreated
a <sub>1</sub> - Prut sand	37
a <sub>2</sub> - perlit granules + sand (1:1)	50
a <sub>3</sub> - black earth + sand (1:1)	92

Table 2 shows large differences in the rooting percentage of untreated cuttings on the three rooting layers. We observe that the highest rooting percentage is obtained with the mixture of black earth + sand (1: 1), 92%, and the percentage difference between it and the Prut sand is 55%. 2 variants of the total of the 3 experimental variants ensured a rooting of over 50%.

Table 3

**Experimental results on the rooting of treated cuttings  
by *Buxus sempervirens* L. under the influence of substrate composition**

Substrate type	Rooted cuttings (%)
	b <sub>2</sub> — treated
a <sub>1</sub> - Prut sand	78
a <sub>2</sub> - perlit granules + sand (1:1)	33
a <sub>3</sub> - black earth + sand (1:1)	100

According to table 3, we notice large differences in the rooting percentage of the cuttings at the level of the three rooting layers due to the risogenic Stimulator treatment Radi-Stim no. 2. We find that the highest rooting percentage

was achieved in the case of the black earth + sand (1: 1) mixture, 100%. Two variants of the three experimental variants ensured a 78% -100% rooting.

The highest rooting percentage was achieved with black / sand (1: 1) mixed soil, 92% -100%. Three variants of the total of the 6 experimental variants ensured a 78% -100% rooting. The rhizogenic substance and the composition of the substrate have differentially influenced the rooting of *Buxus sempervirens* L. cuttings.

Table 4

**Primary results on the rooting of the cuttings of *Buxus sempervirens* L.**

Var. no.	Var. symbol	Average roots length (cm)	Average number of roots (pcs.)
V <sub>1</sub>	a <sub>1</sub> b <sub>1</sub>	6.30	7.00
V <sub>2</sub>	a <sub>1</sub> b <sub>2</sub>	6.30	7.50
V <sub>3</sub>	a <sub>2</sub> b <sub>1</sub>	7.70	26.50
V <sub>4</sub>	a <sub>2</sub> b <sub>2</sub>	8.60	24.60
V <sub>5</sub>	a <sub>3</sub> b <sub>1</sub>	5.50	20.50
V <sub>6</sub>	a <sub>3</sub> b <sub>2</sub>	7.20	18.20

The first data in table 4 was statistically processed to determine the influence of the stimulator and the substrate on the rhizogenesis of *Buxus sempervirens* L. The results are presented and interpreted in tables 5 and 6.

Table 5

**Influence of substrate composition on the average length of roots of untreated cuttings of *Buxus sempervirens* L.**

Var. no.	Substrate type	Average roots length (cm)		Diferences (cm)	Semnific.
		cm	%		
V <sub>1</sub>	Prut sand, untreated cuttings	6.30	100	-	-
V <sub>3</sub>	Perlite granules+sand (1:1)	7.70	116.2	1.20	**
V <sub>5</sub>	Black earth+sand (1:1)	5.50	80	-0.80	00
		DL 5%=0.45	DL 1%=0.76	DL 0.1%=1.40	

It is found that the best results were obtained in variant V3 regarding the influence of the type of substrate on the average length of the untreated *Buxus* roots on 7.70 cm Prut + peat (1: 1) sand substrate with a difference of 1.20 cm (tab. 5).

In rooted cuttings, we observe positive values recorded in variants V4 due to the influence of the factors studied on the root length at the rooted cuttings, perlite granules + sand (1: 1), cut cuttings, with a difference of 2.13 cm from the Prut sand.

Observing the results obtained for the 6 variants analyzed, we observe very positive values recorded on variant V4, perlite granulate + sand (1: 1) substrate, treated cuttings, with a difference of 2.13 cm from the Prut sand and distinct values significantly positive were made on variant V3, perlite granulate + sand (1: 1), to untreated cuttings, with a difference of 1.20 cm from the Prut sand.

Table 6

**The combined influence of the substrate and rhizogenic composition on the average length of the roots of *Buxus sempervirens* L.**

Var. no.	Substrate type	Average roots length (cm)		Diferences (cm)	Semnific.
		no	%		
V <sub>1</sub>	Prut sand, untreated cuttings	6.30	100	-	-
V <sub>2</sub>	Prut sand, treated cuttings	6.30	100	-	-
V <sub>4</sub>	Perlite granules+sand (1:1)	9.64	127.5	2.13	***
V <sub>6</sub>	Black earth+ sand (1:1)	7.20	95.8	-0.50	0
DL 5%=2.67 DL 1%=3.60 DL 0.1%=7.80					

Table 7

**Influence of substrate composition on the average number of roots on untreated cuttings of *Buxus sempervirens* L.**

Var. no.	Substrate type	Average roots number		Diferences (cm)	Semnific.
		no	%		
V <sub>1</sub>	Prut sand	7.00	100	-	-
V <sub>3</sub>	Perlite granules+ sand (1:1)	26.50	373.4	19.50	**
V <sub>5</sub>	Black earth+ sand (1:1)	20.50	280.4	13.50	**
DL 5%=2.67 DL 1%=3.60 DL 0.1%=7.80					

Regarding the influence of the type of substrate on the average number of roots on the *Buxus* untreated cuttings, it was found that the best results are in variant V3, perlite granulate + sand (1: 1) substrate of 26,50, the difference being of 19.50 compared to Prut sand and variant V5, on the ground of black forest + sand (1: 1) with a number of 20.50, the difference being of 13.50 compared to Prut sand (tab. 7), thus showing significant positive differences in the two cases.

The combined influence of the studied factors on the average number of roots in the rooted cuttings shows significant positive values recorded in variants V4 (perlite granulate + sand substrate in 1: 1 ratio), with a difference of 13.30 roots compared to sand of Prut, V6 on a black ground + sand substrate in a ratio of 1: 1, with a difference of 10.20 roots to the Prut sand (tab. 8).



Table 8

**Combined influence of substrate and rhizogenic composition on the average number of roots on *Buxus sempervirens* L.**

Var. no.	Substrate type	Average roots number		Diferences (cm)	Semnific.
		no.	%		
V <sub>1</sub>	Prut sand, untreated cuttings	7.00	100	-	-
V <sub>2</sub>	Prut sand, treated cuttings	7.50	103.0	0.20	-
V <sub>4</sub>	Perlite granules+sand (1:1)	24.60	270.0	13.30	**
V <sub>6</sub>	Black earth +sand (1:1)	18.20	239.2	10.20	**

## CONCLUSIONS

According to recorded and analyzed data, at the end of the rooting period, the following were found:

1. A very good percentage of 90% was obtained by rooting the untreated cuttings on a black soil + sand (1: 1) substrate, with a 50% percentage difference from the Prut sand substrate;
2. Using the rhizogenic stimulator, 100% was obtained in combination with the black soil + sand (1: 1) substrate which influenced the rooting of the previous situation;
3. The perlite granule + sand substrate (1: 1) influenced a long-term increase in the root system of the *Buxus* untreated cuttings; there were significant positive increases;
4. The combination of the studied factors influenced the average number of roots in the rooted cuttings, observing positive values recorded in the variants V<sub>4</sub> (on a perlite granulate + sand substrate in a ratio of 1: 1), with a difference of 13.30 roots from the sand of Prut, V<sub>6</sub> on the ground of black forest + sand in a ratio of 1: 1, with a difference of 10.20 roots to the Prut sand.

It has been found that the substrate provides a triple and double percent of the number of cuttings roots, either treated with or without rhizogenic biostimulators.

The success of a large number of cuttings depends on the roots that will be adapted to the conditions in the nurseries.

## REFERENCES

1. Bernardis R., 2010- *Arboricultură ornamentală.vol.1*. Editura Ion Ionescu de la Brad, Iași
2. Iliescu Ana Felicia, 2002 – *Cultura arborilor și arbuștilor ornamentali*. Editura Ceres, București.
3. Mihail M., 2005 – *Dendrologie*. Editura "Bioterra", București.

## COPPER EFFECT ON THE SEEDLING GROWTH AND DEVELOPMENT FOR THE *ALYSSUM MURALE* SPECIES

### EFFECTUL CUPRULUI ASUPRA CREȘTERII ȘI DEZVOLTĂRII RĂSADURILOR LA SPECIA *ALYSSUM MURALE*

*Maria BRINZA*<sup>1\*</sup>, *Lucia DRAGHIA*<sup>1</sup>, *Elena Liliana CHELARIU*<sup>1</sup>,  
*Andreea AIORDACHIAEI*<sup>1</sup>.

\*Corresponding author e-mail: mariabrinza2007@yahoo.com

**Abstract.** *The aim of the undertaken research was to study the influence of copper on the seedling growth and development for the Alyssum murale species. The experiment was organized in 2 kg soil containers, in 4 variants of 4 repetitions, each repetition having 100 seeds. In order to study the influence of copper on the growth and development of the seedlings, the following doses were used: variant V<sub>1</sub>-20ppm, variant V<sub>2</sub> - 100ppm, variant V<sub>3</sub>- 200ppm and variant V<sub>4</sub> - 500ppm. The toxicity of copper was determined through biometric determinations: stem height number of leaves, internode length, mean length of the main stem, number and mean length of secondary roots and the photosynthetic pigments content by using the spectrophotometric method. The increase in copper concentration has induced a reduction of the mean plant height, the differences obtained being negative, very significant in variants V<sub>2</sub>, V<sub>3</sub> and V<sub>4</sub>. The increase in the copper content in the substrate, in variants V<sub>3</sub> and V<sub>4</sub>, has determined the decrease in the chlorophyll a content.*

**Key words:** *Alyssum murale, copper, photosynthetic pigments*

**Rezumat.** *Scopul cercetărilor efectuate au constat în studierea influenței cuprului asupra creșterii și dezvoltării răsadurilor la specia Alyssum murale. În acest sens, a fost luată în studiu una din speciile ornamentale din flora spontană, ce au fost conservate ex-situ (Alyssum murale). Experiența a fost organizată în în containere cu volumul de 2 kg sol, în 4 variante a câte 4 repetiții, fiecare repetiție având câte 100 de semințe. Pentru studierea influenței cuprului asupra creșterii și dezvoltării răsadurilor s-au folosit următoarele doze: varianta V<sub>1</sub>- 20ppm, varianta V<sub>2</sub> - 100ppm, varianta V<sub>3</sub>- 200ppm, varianta V<sub>4</sub>- 500ppm. Toxicitatea cuprului asupra creșterii răsadurilor a fost apreciată prin determinari biometrice ce au cuprins înălțimea tulpinilor și uniformitatea creșterii și dezvoltării, numărul de frunze, lungimea internodurilor, lungimea medie a rădăcinii principale, numărul de rădăcini secundare și lungimea medie a rădăcinilor secundare. De asemenea, pentru a evidenția influența cuprului asupra proceselor fiziologice s-au efectuat determinări privind conținutului de pigmenți fotosintetici prin metoda spectofotometrică. Creșterea concentrației de cupru a indus o reducere a înălțimii medii a plantelor, diferențele obținute fiind*

<sup>1</sup>University of Agricultural Sciences and Veterinary Medicine Iasi, Romania

*negative, foarte semnificative la variantele V<sub>2</sub>, V<sub>3</sub> și V<sub>4</sub>. Creșterea conținutului de cupru în substrat, la variantele V<sub>3</sub> și V<sub>4</sub> a determinat scăderea conținutului de clorofilă a.*

**Cuvinte cheie:** *Alyssum murale*, cupru, pigmenți fotosintetici

## INTRODUCTION

In recent years, scientists have begun to generate cost-effective technologies, including the use of micro-organisms or live plants, for cleaning polluting areas (Qui *et al.*, 2006; Kuzovkina *et al.*, 2004). Phytoremediation refers to the natural ability of certain plants to bioaccumulate, degrade or render harmless isolates in soil, water and air, through a natural, biological, physical and chemical way, through the plants actions and processes.

Phytoremediation is an emerging technology that should be taken into consideration for the remediation of contaminated sites for being cost-effective, due to aesthetic benefits and long-term applicability (Boonyapookana *et al.*, 2005).

Research on phytoremediation carried out over time has highlighted the favorable effect of some plant species, including ornamental ones, on the environmental depollution through the absorption of pollutants by roots and their accumulation in the plant.

Some heavy metals, in low doses, are essential micronutrients for plants, but in higher doses, they can cause metabolic disturbances and cause inhibition for most plant species (Sinha, 2005). It is known that in some concentrations, some heavy metals (Cu, Fe, Mn) do not inhibit plant metabolism, but are essential for photosynthesis (Anjali Aggarwal *et al.*, 2012).

Copper (Cu) contributes to several physiological processes in the plant (photosynthesis, respiration, carbohydrate and nitrogen distribution, cell wall metabolism, seed production), including resistance to disease (Kabata-Pendias and Pendias, 2001).

The deficiency of some metals (Cu, Fe, Mn) has a direct impact on the photosynthesis process, but in very high concentrations, these metals become toxic for the cells (Baker and Walker, 1989) and affect photosynthesis in many ways (Gross *et al.*, 1970; Wong and Genter, 1996).

## MATERIAL AND METHOD

In order to study the influence of copper on the growth and development of the seedlings, the following doses were used: - 20ppm, variant V<sub>1</sub>; 100ppm, variant V<sub>2</sub>; 200ppm, variant V<sub>3</sub>; 500ppm, variant V<sub>4</sub>.

In order to contaminate the substrate, the following stages were followed:

preparing the substrate and contamination of the substrate (the necessary quantity of  $\text{CuSO}_4$  was calculated in order to obtain a contamination of Cu of 20ppm, 100ppm, 200ppm and 500ppm respectively, from which the solutions were prepared).

The experiment was organized in 2 kg soil containers, in which 100 seeds were sowed, each experimental variant being organized in three repetitions.

The growth of the seedlings was carried out in the SANYO (MLR-351H) germinator, at a temperature of  $22\pm 1^\circ\text{C}$  for 8 hours, a relative air humidity of approximately 80% and a luminous intensity of over 8.000 lux.

The influence of copper on the quality of the seedlings was seen at the level of stem height, growth and development uniformity, number of leaves, internode length, mean length of the main stem, number of secondary roots and mean length of secondary roots.

Also, in order to highlight the influence of copper on the physiological processes, determinations have been carried out to measure the photosynthetic pigments content.

The extraction and determination of the assimilatory pigments were carried out in accordance with the Current Protocols in Food Analytical Chemistry (Lichtenthaler and Buchmann, 2001). The tissues of the fresh leaves (0,1 g) were ground in the mortar in acetone (pure solvent) and then centrifuged at  $10000 \times g$  for 5 minutes. After centrifugation, the reading of the supernatant was done at the absorbance of 661.6 nm for chlorophyll a (Chl. a), at 644.8 nm for chlorophyll b (Chl. b) and at 470 nm for carotenoids (car.), using the T70 UV/VIS Spectrophotometer PG.

## RESULTS AND DISCUSSIONS

Based on the measurements carried out on the variants contaminated with different doses of copper, a tendency of decrease in the average height of the plants is observed, in conjunction with the increase in the copper concentration.

By comparing the results obtained from the contaminated variants with the ones obtained from the control variant it may be noted that the copper dose that represents the maximum admitted value does not affect the quality of the seedlings.

The increase in height of plants from variant  $V_1$  was of 3.2 cm, a value that is very close to the one obtained by the control variant, namely of 3.5 cm (table 1).

The number of leaves per plant varied from 10 leaves in the plants from the control variant to 6 leaves in variants  $V_3$  and  $V_4$ .

The highest copper concentrations have induced the decreased in the length of internodes, compared with the plants from the control variant, the values obtained within the two experimental variants ( $V_3$  and  $V_4$ ) being very reduced.

Table 1

Influence of copper on the *Alyssum murale* seedling growth

Species	Variant	H (cm)	No. Lvs.	L.i. (cm)	L. m. r. (cm)	No. s. r.	L. s. r. (cm)
<i>Alyssum murale</i>	C	3.5	10	0.40	4.7	12	1.51
	V <sub>1</sub>	3.2	10	0.34	4.5	11	1.02
	V <sub>2</sub>	2.3	8	0.30	3.3	9	0.90
	V <sub>3</sub>	1.9	6	0.20	3.0	7	0.75
	V <sub>4</sub>	1.3	6	0.20	2.3	6	0.73

\*H – plant height (cm)

No. Lvs. – number of leaves per plant (pieces)

L.i. – length of internodes (cm)

L. m. r.- length of main root (cm)

No. s. r. – number of secondary roots (pieces)

L. s. r. – average length of secondary roots (cm)

The biometric determinations regarding the main root growth in seedlings, under the conditions of contamination with this metal have presented the most accentuated decrease in variant V<sub>4</sub> (2.3).

The copper toxicity in a 500 ppm dose was reflected in the values regarding the number and mean length of secondary roots. Compared with the control variant, the plants from this variant have presented very reduced values of the number and mean length of roots.

The differences compared with the control variant were negative, distinctly significant in plants from variants V<sub>2</sub> and very significant in plants from variants V<sub>3</sub> and V<sub>4</sub>.

Table 2

## Results regarding the average length of the main root

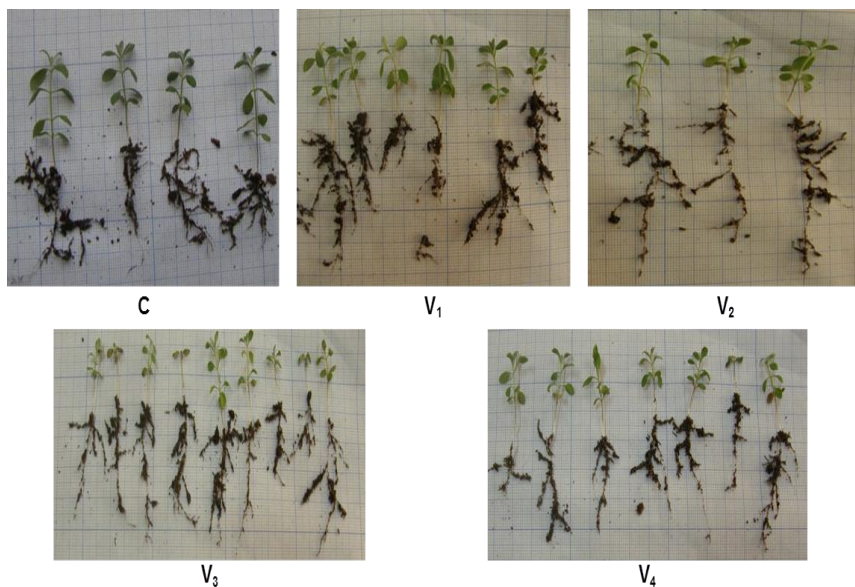
Species	Variant	L. m.r (cm)	% compared to control variant	± d	Difference significance
<i>Alyssum murale</i>	C	4.7	100.00	0.0	-
	V <sub>1</sub>	4.5	95.74	-0.2	-
	V <sub>2</sub>	3.3	70.21	-1.4	00
	V <sub>3</sub>	3.0	63.83	-1.7	000
	V <sub>4</sub>	2.3	48.94	-2.4	000
	DL5% - 0.7 cm DL 1% - 1.0 cm DL 0.1% - 1.6 cm				

The influence of copper toxicity on the average number of roots was reflected by the significance of the difference compared with the control variant, obtained through the statistical interpretation of the results.

Negative differences were obtained compared with the control variant, distinctly significant in variant  $V_2$  and very significant in variants  $V_3$  and  $V_4$ .

**Table 3**  
Results regarding the number of roots in the seedlings obtained on substrate contaminated with different Cu doses

Species	Variant	No. roots (pieces)	% compared to control variant	$\pm d$	Difference significance
<i>Alyssum murale</i>	C	12	100.00	0.0	-
	$V_1$	11	91.67	-1.0	-
	$V_2$	9	75.00	-3.0	00
	$V_3$	7	58.33	-5.0	000
	$V_4$	6	50.00	-6.0	000
	DL5% - 1.7 p. DL 1% - 2.4 p. DL 0,1% - 3.6 p.				



**Fig. 1** *Alyssum murale* seedlings obtained on substrate contaminated with different doses of Cu

By comparing the results obtained from the four experimental variants with the ones obtained from the control variant, a slight increase in the content of pigments and the content of chlorophyll a is observed in the variants that contain more reduced doses of Cu.

The total content of chlorophyll pigments has varied between 2.81 mg/g f.w. in the control variant and 3.71 mg/g f.w. in variant V<sub>4</sub>.

Compared with the control variant, for the seedlings from the experimental variants that were contaminated with doses that represent the maximum admitted limit (V<sub>1</sub>) and the alert threshold (V<sub>2</sub>) there were obtained the highest level of chlorophyll a content.

The influence of copper on the increase in chlorophyll a content is highlighted by the values obtained by variants V<sub>1</sub> and V<sub>2</sub>, which have registered increases by 0.07 mg/g f.w. and by 0.11 mg/g f.w. respectively.

The increase in the copper content in the substrate, in variants V<sub>3</sub> and V<sub>4</sub>, has determined the decrease in the chlorophyll a content, the results confirming the studies done and indicating that these doses are toxic for the plants.

In these variants there was observed a decrease by 0.11 mg/g f.w. in variant V<sub>3</sub>, and by 0.13 mg/g f.w. in variant V<sub>4</sub>. The results regarding the chlorophyll b content have indicated normal values that varied between 0.52 mg/g f.w. and 0.62 mg/g f.w.

Under the conditions of contamination with different copper doses, the chlorophyll a/b ratio has presented values that were within theoretical limits.

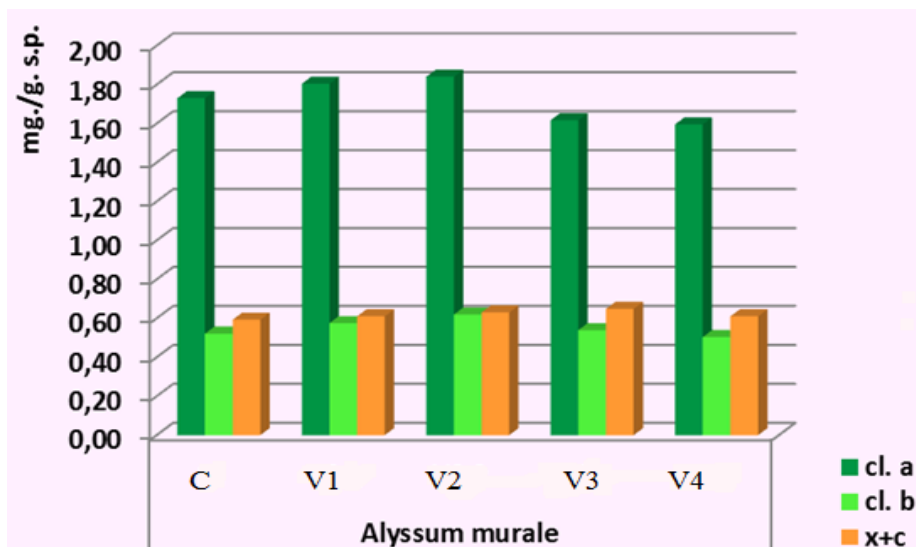


Fig. 2 Content of assimilatory pigments in seedlings obtained on substrate contaminated with different doses of Cu

In seedlings obtained in substrate contaminated with Cu, the chlorophyll a/b ratio has varied between 3.32 mg/g f.w. in the control variant and 2.97 mg/g f.w. in variant V<sub>2</sub>.

Analyzing the values obtained by calculating the ratio  $(Cl. a+Cl. b)/(c+x)$  it is noted that the results do not indicate a physiological stress accentuated in the conditions of soil pollution with the doses of copper used in some concentrations.

In the case of this indicator the values have varied between 3.90 mg/g f.w. in variants V<sub>1</sub> and V<sub>2</sub> and 3.33 mg/g f.w. in variant V<sub>3</sub>.

Table 4

**Content of assimilatory pigments in the seedlings obtained on substrate contaminated with different Cu doses**

Species	Variant	$\Sigma$	Cl. a/Cl. b	Cl. a+b/ x+c
<i>Alyssum murale</i>	C	2.84	3.32	3.80
	V <sub>1</sub>	2.99	3.14	3.90
	V <sub>2</sub>	3.09	2.97	3.90
	V <sub>3</sub>	2.81	3.00	3.33
	V <sub>4</sub>	2.71	3.17	3.44

## CONCLUSIONS

The increase in the copper concentration has induced a reduction in the mean plant height, the differences obtained being negative, very significant in variants V<sub>2</sub>, V<sub>3</sub> and V<sub>4</sub>.

Through the statistical interpretation of the results regarding the number and mean length of secondary roots, negative differences were obtained, very significant in the plants from variants V<sub>3</sub> and V<sub>4</sub>.

The copper doses that have represented the maximum permitted limit and the alert threshold have determined a slight increase in the total content of pigments and in the chlorophyll a content.

The increase in the copper content in the substrate, in variants V<sub>3</sub> and V<sub>4</sub>, has determined the decrease in the chlorophyll a content, these results indicating a decrease by 0.11 mg/g s.p in variant V<sub>3</sub>, and by 0.13mg/g.s.p. in variant V<sub>4</sub>.

The chlorophyll a/b ratio and the chlorophyll/carotenoid pigments have presented values that were within theoretical limits, the values obtained in all experimental variants not indicating any physiological stress accentuated in the conditions of soil pollution with the doses of copper used in the study.



## REFERENCES

1. Anjali Aggarwal, Iti Sharma, Tripathi B.N., Munjal A.K., Mamta Baunthiyal, Sharma V., 2012 - *Photosynthesis: Overviews on Recent Progress & Future Perspective*.
2. Boonyapookana B., Parkpian P., Techapinyawat S., Delaune R.D., Jugsujinda A., 2005 - *Phytoaccumulation of lead by Sunflower (Helianthus annuus), Tobacco (Nicotiana tabacum) and Vetiver (Vetiveria zizanioides)*. Journal of Environmental Science and Health, **40**, pp. 117-137.
3. Genter R.B., 1996 - *Ecotoxicology of inorganic stresses*. In: RJ Stevenson, ML Bothwell, RL Lowe (eds.), *Algal Ecology: Freshwater Benthic Ecosystems*. Academic Press, San Diego, pp. 403-468.
4. Gross R.E., Pungo P., Dugger W.M., 1970 - *Observation of the mechanism of copper damage in Chlorella*. Plant Physiol., **46**, pp. 183-185.
5. Kabata-Pendias A., Pendias H., 2001 - *Trace Elements in Soil and Plants* (3rd Ed.). CRC Press, pp. 65.
6. Kuzovkina Y.A., Knee M., Quigley M.F., 2004 - *Cadmium and copper uptake and translocation in five Willow (Salix L.) species*. International Journal of Phytoremediation, **6**, 269-287.
7. Lichtenthaler H. K. and Buchmann C., 2001 - *Current Protocols in Food Analytical Chemistry. Chlorophylls and Carotenoids: Measurement and Characterization by UVVIS*. Spectroscopy F 4.3.1-F 4.3.8.3.
8. Qiu R., Fang X., Tang Y., Du S., Zeng X., 2006 - *Zinc hyperaccumulation and uptake by Potentilla Griffithii Hook*. International Journal of Phytoremediation, **8**, pp. 299-310.
9. Sinha S., Pandey K., Gupta A.K., Bhatt K., 2005 - *Accumulation of metals in vegetables and crops grown in the area irrigated with river water*. Bull. Environ. Contam. Toxicol., **74**, pp. 210-218.
10. Wong P.K., Chang L., 1991 - *Effects of copper, chromium and nickel on growth, photosynthesis, and chlorophyll a synthesis of Chlorella pyrenoidosa*. Environ. Pollut., **72**, pp. 127-140.

**‘SISSI’ - COLOUR AND PERFUME INTO THE ROSES  
COLLECTION FROM UASVM IAȘI, ROMANIA**

**‘SISSI’ - CULOARE ȘI PARFUM ÎN COLECȚIA DE TRANDAFIRI DE  
LA USAMV IAȘI, ROMÂNIA**

**CHELARIU Elena Liliana<sup>1</sup>, COJOCARIU Mirela<sup>\*</sup>, DRAGHIA Lucia<sup>1</sup>,  
BRÎNZĂ Maria<sup>1</sup>, AVARVAREI B.V.<sup>1</sup>, BERNARDIS R.<sup>1</sup>,  
AMIȘCULESEI Petronica<sup>1</sup>**

<sup>\*</sup>Corresponding author e-mail: mirelacojocariu@gmail.com

**Abstract.** *In the current paper are presented the results regarding behaviour of ‘Sissi’ roses in cropping conditions of roses collection from UASVM Iași, Romania. During vegetation period were monitoring the following features: bush form, bush vigour, aspect of leafage, resistance at pathogen agents attack, rod and floral peduncle, flowering intensity, rosebud shape, shape of opened flowers, flower’s durability, colour of petals at opening, colour of petals at flowering, falling mode of petals, flowers’ perfume, other aspects (adaptability at cropping conditions). At the end of research was observed that ‘Sissi’ roses had a very good adaptation at cropping conditions from the NE area of Romania, decorating from spring till late in autumn with flowers which had a delicate and tender perfume.*

**Key words:** adaptation, roses, ‘Sissi’

**Rezumat.** *În această lucrare sunt prezentate rezultatele privind comportarea trandafirilor ‘Sissi’ în condițiile de cultură din colecția de trandafiri a USAMV Iași, Romania. Pe parcursul perioadei de vegetație s-au monitorizat următoarele însușiri: forma tufei, vigoarea tufei, aspectul frunzișului, rezistența la atacul agenților patogeni, tija și pedunculul floral, intensitatea înfloritului, forma bobocului, forma florilor deschise, durabilitatea florii, culoarea petalelor la deschidere, culoarea petalelor la înflorire, modul de cădere al petalelor, parfumul florilor, alte aspecte (adaptarea la condițiile de cultură). În urma cercetărilor s-a constatat că trandafirii ‘Sissi’ s-au adaptat foarte bine la condițiile de cultură din zona de NE a României, decorând din primăvară până toamna târziu, cu florile suav parfumate.*

**Cuvinte cheie:** adaptare, trandafiri, ‘Sissi’

## INTRODUCTION

*Rosa hybrida* L. (rose) is one of those 200 species of *Rosa* genus from Rosaceae family. Genus *Rosa* have numerous ornamental cultivars with utilization as cut flowers in floral art (Kras, 1999; Gudín, 2000; Buta and Cantor, 2015; Chelariu *et al.*, 2017) as well as in landscape designs (Wagner, 2002; Cantor and Buta 2010; Chelariu *et al.*, 2017).

<sup>1</sup>University of Agricultural Sciences and Veterinary Medicine from Iași, Romania

Rose is considered a symbol of elegance, affection, spirituality, inspiration and source of aesthetic satisfaction for man (Gudin, 2000). It is known from the ancient times. In Crete was discovered a drawing with roses which was dated from 1500-1600 B.C. (Al-Zwelef, 2015). Roses are cultivated from Europe to Asia, America and Australia (Wagner, 2002; Viraraghavan Girija and Viraraghavan, 2015; McNamara, 2015; Mattock, 2015) and are involved in every each event from human life (Gudin, 2000; Iftikhar Ahmad *et al.*, 2010).

During time, due to breeding processes, were obtained numerous roses' cultivars which can adapt function of ecological demands of plants (Wagner, 2002; Chakrabarti, 2015; Chelariu *et al.*, 2017).

The current study aimed to present the behaviour of 'Sissi' roses in cropping condition from Iași City, Romania.

## MATERIAL AND METHOD

Research took place during 2016-2018, in rose's collection of Floriculture Discipline, Faculty of Horticulture from USAMV Iași, Romania. The studied material was represented by 'Sissi' hybrid tea roses, which were planted into collection in autumn of 2015.

Created by Mathias Tantau Jr. (Germany) in 1964 from a combination between Sterling Silver (Hybrid Tea, obtained by Fisher in 1957) and an unknown, these variety was recorded under the name of MainzerFastnacht (TANacht), and as commercial name Blue Moon, but also have numerous synonyms (Sissi, Blue Moon, Blue Monday, NavoRose, Mainzer Rad, TANSi, TANSi0343), the most frequent one being synonym Sissi.

Rose 'MainzerFastnacht' or 'Sissi' (fig. 1) is a very popular variety. It received different awards such as: ADR test 1964, MA Rome 1964, CM England 1964.



**Fig. 1** 'Sissi' – plant (original)

The shape is as a vigorous bush (80-110/45 cm), with an erect growing and thin branches which present few thorns. Leaves are medium, with a dark green colour, semi-glossy, and with a rare disposal on sprouts. From this reason plants have few

leaves, and in autumn those ones seems a little bit barren.

Flowers appear, usually, solitary on stem, rarely two – three. Flowers are characterized by a remarkable combination between shapes; perfume and colour make a nice contrast with the dark green coloured leaves.

Literature mention that 'Sissi' rose flowers have a blue colour (<http://www.helpmefind.com/rose/l.php?l=2.757.5>; Wagner, 2002, 2010; Mikolajski, 2007), but in reality those ones are a mixture of silver-violet or mauve lavender with silver reflections, pearl-scent. At a high luminous intensity, flowers' nuance is lighter, turning slightly too pink. Rosebuds are long, sharpened, with a noble shape and opened into large flowers (10-12 cm), abundant, with 20-25 petals slightly outward-facing and extremely perfumed. The perfume of this rose is characterized as being fresh, intense, fruity, spicy and sometimes sweetish.

Those roses had a long period of flowering, from the beginning of summer till late in autumn.

It is a variety which demand short cuts, because present vigorous young spouts. 'Sissi' roses need protection over winter against very low temperatures. 'Sissi' presents sensibility at black spot. Could be cultivated in fields for cut flowers or in diverse vegetal composition from landscape designs (<http://www.helpmefind.com/rose/l.php?l=2.757.5>; Wagner, 2002, 2010; Mikolajski, 2007)

Research were carried out from May to October, on the basis of a special sheet in which were noted the aimed characters and features: bush form (5 points), bush vigour (8 points), aspect of leafage (8 points), resistance at pathogen agents attack (8 points), rod and floral peduncle (5 points), flowering intensity (10 points), rosebud shape (10 points), shape of opened flowers (7 points), flower's durability (5 points), colour of petals at opening (6 points), colour of petals at flowering (6 points), falling mode of petals (5 points), flowers' perfume (7 points), other aspects (adaptability at cropping conditions) (10 points), (Wagner, 2002). The obtained mean values during research period were recorded into a centralizing table. Based on the obtained results was appreciated the behaviour of 'Sissi' roses in cropping conditions from Iași City, Romania.

## RESULTS AND DISCUSSIONS

During research period, 'Sissi' roses formed vigorous bushes, appreciated with 7.8 points from a maximum of 8 points (tab. 1). On sprouts were formed leaves with a medium size, having a dark green colour, semi-glossy. Foliage aspect was appreciated with 7.1 points from a maximum of 8 (tab. 1).

On floriferous rods were formed long, sharp conical rosebuds (fig. 2), which opened in large flowers, abundant with petals outward-facing, having a violet-lavender colour (fig. 3a-b), strongly perfumed.

Floriferous rods and floral peduncle are vigorous (4.8 points). Rosebuds presented the characteristic shape of variety and were appreciated with 9.8 points from a maximum of 10 points (tab. 1).

Flowers have an elegant and noble shape from their opening (6.8 points) till the ending of flowering. Flowers kept their colour from flowering till falling of petals, being appreciated with the maximum (6 points). Falling way of petals was appreciated with 3.7 points, this one being less highlighted (tab. 1).



**Fig. 2** 'Sissi' – buds (original)



a)



b)

**Fig. 3** 'Sissi' – a) semi-opened flower; b) complete flowering (original)

'Sissi' roses have a great flowering intensity (9.8 points), from May till late in autumn, with a flowers' durability appreciated with 4.8 points from a maximum of 5 points.

At roses, flowers perfume is one of the basic qualities, and its intensity is correlated with flowers colour. Generally, roses have a discreet perfume (Buta and Cantor, 2015), but are also roses with an intense perfume, and among them are 'Sissi' roses. From the point of view of perfume intensity, this rose variety was appreciated as being very perfumed, aspect noted with the maximum score (7 points) (tab. 1).

'Sissi' roses are sensitive to attack of some pathogen agents (6.8 points).

At the end of realised observations during research we could say that 'Sissi' roses had a very good adaptation at cropping conditions from Iași area, Romania, summing a total score of 94.9 points from a maximum of 100 possible points (tab. 1).

Based on the obtained results we could appreciate that 'Sissi' roses could be capitalized in vegetal compositions from landscape designs in Iași area, Romania, as well as in other areas with similar cropping conditions.

Table 1

**Evaluation of ‘Sissi’ variety in cropping conditions from Iași, Romania  
(mean values 2016-2018)**

Evaluated character	Maximum score	Decade/month										Mean score / character
		III. 05	II. 06	III. 06	II. 07	III. 07	II. 08	III. 08	II. 09	III. 09	II. 10	
bush form	5	5	5	5	5	5	5	5	5	4	4	4.8
bush vigour	8	8	8	8	8	8	8	8	8	7	7	7.8
aspect of leafage	8	8	8	8	8	7	7	7	6	6	6	7.1
resistance at pathogen agents	8	8	8	8	7	7	6	6	6	6	6	6.8
rod and floral peduncle	5	5	5	5	5	5	5	5	5	4	4	4.8
flowering intensity	10	10	10	10	10	10	10	10	10	9	9	9.8
rosebud shape	10	10	10	10	10	10	10	10	10	9	9	9.8
shape of opened flowers	7	7	7	7	7	7	7	7	7	6	6	6.8
flower durability	5	5	5	5	5	5	5	5	5	4	4	4.8
colour of petals at opening	6	6	6	6	6	6	6	6	6	6	6	6.0
colour of petals at flowering	6	6	6	6	6	6	6	6	6	6	6	6.0
falling mode of petals	5	4	4	4	4	4	4	4	3	3	3	3.7
flowers' perfume	7	7	7	7	7	7	7	7	7	7	7	7.0
adaptability at cropping conditions	10	10	10	10	10	10	10	9	9	9	9	9.7
TOTAL SCORE												94.9

## CONCLUSIONS

In conclusion, ‘Sissi’ roses had a good behaviour in cropping conditions from Iași area, Romania (94.9 points), forming vigorous bushes, with large flowers, perfumed, with a long period of flowering, being able to assure the décor during whole summer till autumn when frozen are coming.

These results sustain the capitalization of this rose’s in vegetal composition from landscape designs from Iași area, Romania as well as in other areas with similar cropping conditions.

*Acknowledgments: The research from the current paper was funded from research grant with private funds nr. 19993 / 2014.*

## REFERENCES

1. **Al-Zwelef K.M., 2015** – *Glimpses of the rose journey-in myth, legend and poetry*. The Indian Rose Annual XXXI, The Indian Rose Federation, p. 15-22. [www.indianrosefederation.com/img/annualreport-2015-wrc.pdf](http://www.indianrosefederation.com/img/annualreport-2015-wrc.pdf)
2. **Buta Erzsebet, Cantor Maria, 2015** – *Artă florală*. Editura Academic Pres, Cluj Napoca, ISBN 978-973-744-462-2, p. 229
3. **Cantor Maria, Buta Erzsebet, 2010** – *Artă florală*. Editura Todesco, Cluj Napoca
4. **Chakrabarti Kalyan, 2015** – *Knowing roses: old Gardens Roses*, p. 217-221, The Indian Rose Annual XXXI, The Indian Rose Federation, <https://www.indianrosefederation.com/img/AnnualReport-2015-WRC.pdf>
5. **Chelariu Elena Liliana, Cojocariu Mirela, Draghia Lucia, Brînză Maria, Avarvarei B.V., 2017** – *Research regarding the behaviour of some rose from thea group in cropping conditions from Iași County, Romania*. Lucrări științifice, USAMV Iași, seria Horticultură, vol. 60, nr. 2, p. 291-298
6. **Gudin S., 2000** – *Rose genetics and breeding*. In: Reviews (Ed. J. Janick), vol. 17: p. 159-189. John Wiley & Sons, Inc.
8. **Iftikhar Ahmad, Aslam Khan M., Qasim M., Rashid Ahmad, Mahmood A. Randhawa, 2010** – *Growth, yield and quality of Rosa hybrida L. as influenced by various micronutrients*. Pak. J. Agri. Sci., Vol. 47(1): p. 5-12, ISSN (Print) 0552-9034, ISSN (Online) 2076-0906, <http://www.pakjas.com.pk>
9. **Kras J., 1999** – *Marketing of cut flowers in the future*. Acta Hort. 482: 401-405.
10. **Mattock E.R., 2015** – *Silk road hybrids*. The Indian Rose Annual XXXI, The Indian Rose Federation, p. 35-45 <https://www.indianrosefederation.com/img/annualreport-2015-wrc.pdf>
11. **Mcnamara A.W., 2015** – *Wild roses in Asia and the Quarryhill Botanical Garden*. The Indian Rose Annual XXXI, The Indian Rose Federation, p. 23-34, <https://www.indianrosefederation.com/img/annualreport-2015-wrc.pdf>
12. **Mikolajski A., 2007** – *Roses: Selecting, Growing*, Publisher Hove Apple, ISBN 9781845432089, p. 256
13. **Viraraghavan G., Viraraghavan M.S., 2015** – *Sustainable Rose Breeding/Growing For Tropical Asia – Some Possibilities: An Editorial Overview*. The Indian Rose Annual XXXI, The Indian Rose Federation, p. 5-14, [www.indianrosefederation.com/img/annualreport-2015-wrc.pdf](http://www.indianrosefederation.com/img/annualreport-2015-wrc.pdf)
14. **Wagner Șt., 2002** – *Trandafirul – de la mit la milenul trei*. ECHARD&Co SNC Cluj-Napoca, ISBN 973-0-02590-8, p. 284
15. **Wagner Șt., 2010** – *Trandafiri cu parfum*, Editura Napoca Star, Cluj-Napoca
16. \*\*\*, <http://www.helpmefind.com/rose/l.php?l=2.757.5>

## VERMICOMPOST INFLUENCE ON PRODUCTION OF *OCIMUM BASILICUM L.* SEEDLINGS

### INFLUENȚA VERMICOMPOSTULUI ASUPRA PRODUCERII RĂSADURILOR DE *OCIMUM BASILICUM L.*

CHELARIU Elena Liliana<sup>1\*</sup>, GHIORGHE C.<sup>2</sup>, TURCU N.<sup>1</sup>

\*Corresponding author e-mail: julia@uaiasi.ro

**Abstract.** In the current paper are presented the results obtained regarding the influence of vermicompost on production of basil seedlings, *Ocimum basilicum L.* Research took place at UASVM Iași, Romania, in 2018. Experiences were organized in four variants represented by participation rate of vermicompost in substrate together with garden soil, respectively 0% (V<sub>1</sub>), 10% (V<sub>2</sub>), 20% (V<sub>3</sub>) and 30 % (V<sub>4</sub>). Seedlings with the best quality were obtained at a rate of 30% vermicompost in substrate (V<sub>4</sub>).

**Key words:** germination, *Ocimum basilicum*, vermicompost

**Rezumat.** În această lucrare sunt prezentate rezultatele privind influența vermicompostului asupra producerii răsadurilor de busuioc, *Ocimum basilicum L.* Cercetările s-au desfășurat la USAMV Iași, România, în anul 2018. Experiențele au fost organizate în patru variante reprezentate de proporția în care a participat vermicompostul în substrat alături de pământul de grădină, respectiv 0% (V<sub>1</sub>), 10% (V<sub>2</sub>), 20% (V<sub>3</sub>) și 30% (V<sub>4</sub>). Răsadurile de cea mai bună calitate s-au obținut la un aport de 30% vermicompost în substrat (V<sub>4</sub>).

**Cuvinte cheie:** germinație, *Ocimum basilicum*, vermicompost

## INTRODUCTION

*Ocimum basilicum L.* is important as ornamental plant (cut flower in fresh state or dried, for decor of green spaces), as well as aromatic plant (in food, cosmetic, pharmaceutical industry).

Seedlings production is an important link in plants' cropping. At basil, in laboratory conditions, seeds germination could reach 95-98%, if optimal temperature is 25°C (Birendra, 2012; Ramin, 2006). Germination of basil seeds could be difficult in saline conditions and in unfavourable temperature conditions. Basil could be classified as moderate tolerant at saline stress during seeds' germination and apparition of seedlings (Ramin, 2006).

Basil reacts positively at nutritive substrate type, especially at organic substrates (Jelačić *et al.*, 2005). In last years, we look for variants as environmental friendly as possible, in all technological links for plants cropping, avoiding as much as it is possible utilisation of nutritive substances obtained by chemical synthesis. So, were tested and utilised many organic variants and among them being utilisation of bio-humus or vermicompost.

<sup>1</sup>University of Agricultural Sciences and Veterinary Medicine from Iași, Romania

<sup>2</sup> SC SUPERPĂMÂNT SRL Iași, Romania



Vermicompost improves seeds' germination rate and seedlings' quality, due to its physical, biological and nutritional properties, and could be a source of bioactive molecules and microbial populations. These bioactive compounds and micro-organisms intensify the absorption of nutrients, initial development of roots and seedlings' development capacity (McGinnis *et al.*, 2004; Kalra *et al.*, 2010; Mathivanan *et al.*, 2012).

Positive effect of vermicompost on seeds' germination and seedlings' quality was observed at different plant species: legumes (Suthar *et al.*, 2005; Singh *et al.*, 2011); *Arachis hypogaea* L. (Kalra *et al.*, 2010; Mathivanan *et al.*, 2012); ornamental grasses (Chelariu and Ghiorghe, 2017).

In the current paper are presents results regarding vermicompost influence on basil seeds germination and seedlings quality before planting.

## MATERIAL AND METHOD

Experiences for the current research were organized into the didactical glasshouses belonging to Floriculture discipline, UASVM Iași, Romania, in 2018. For the design of those experiences was used as study material species *Ocimum basilicum* L.

Were established four experimental variants, represented by the participation rate into substrate of vermicompost together with garden soil, respectively 0% ( $V_1$ ), 10% ( $V_2$ ), 20% ( $V_3$ ) and 30% ( $V_4$ ) (tab. 1). On each variant were sowed 50 seeds. For seedlings transplanting was utilised the same substrate as at sowing.

Table 1

Experimental design for *Ocimum basilicum* L. species

Species	Variant	Substrate type
<i>Ocimum basilicum</i>	$V_1$	garden soil (control)
	$V_2$	garden soil + 10% vermicompost
	$V_3$	garden soil + 20% vermicompost
	$V_4$	garden soil + 30% vermicompost

Research took place during March-May 2018, and we observed germination dynamics of seeds, germination rate, and characterization of seedlings before establishment of crops. The obtained results were statistically.

## RESULTS AND DISCUSSIONS

Production of planting material at floral plants is one of the important technological links with implication into a successful cropping. Various factors could influence seedlings production, one of them being the utilized substrate for sowing and transplanting, as the case may be.

At the end of research was observed that germination of *Ocimum basilicum* seeds took place during 15 days at variants which in substrate had a rate of vermicompost, and at control variant  $V_1$  majority of seeds germinated into an interval of 20–25 days (fig. 1).

Germination rate of seeds was between 81% at control variant ( $V_1$ ) and 92% at  $V_2$  (10% vermicompost), 94% at  $V_3$  (20% vermicompost) and 96% at  $V_4$  (30% vermicompost) (tab. 2).

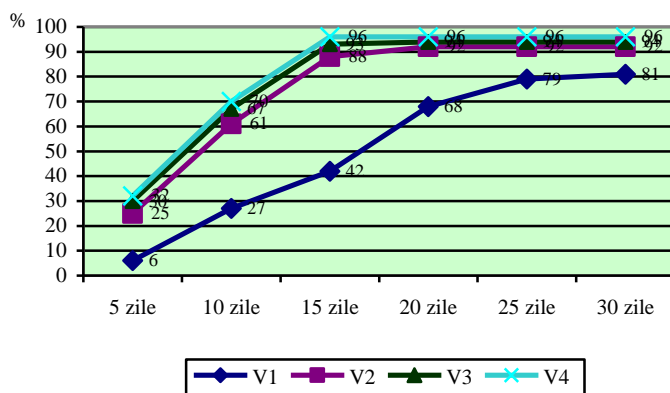


Fig. 1 Germination dynamics at *Ocimum basilicum*

After statistical interpretation was observed that differences face to control were very positive significant at those three variants which have included vermicompost into substrate (tab. 2).

Table 2

Results regarding influence of substrate on *Ocimum basilicum* seeds germination rate

Variant	Germinated seeds (%)	% face to control	Difference	Significance
V <sub>1</sub> - control	81	100.00	0,0	control
V <sub>2</sub> - 10% vermicompost	92	113.58	11.0	***
V <sub>3</sub> - 20% vermicompost	94	116.05	13.0	***
V <sub>4</sub> - 30% vermicompost	96	118.52	15.0	***
LD <sub>5%</sub> = 3.7    LD <sub>1%</sub> = 5    LD <sub>0.1%</sub> = 9.0				

Basil seedlings were observed from the point of view of morphological features such as plants' mean height, leaves' mean number and mean number of roots on plant at the end of germination period.

Presence of vermicompost in substrate influenced features of basil seedlings. So, seedlings mean height was 10.3 cm at control variant (V<sub>1</sub>) and between 14.9 cm and 16.3 cm at variants with vermicompost. Mean number of leaves was 10.3–12.5 pcs/plant at variants with vermicompost face to 8.2 pcs/plant at control variant (tab. 3).

Table 3

Characterization of *Ocimum basilicum* seedlings

Variant	After 30 days from sowing			
	Mean height (cm.)	Mean number of leaves (pcs.)	Mean number of ramifications (pcs.)	Mean number of main roots (pcs.)
V <sub>1</sub> - control	10.3	8.2	1.1	8.3
V <sub>2</sub> - 10% vermicompost	14.9***	10.3***	2.1***	12.5***
V <sub>3</sub> - 20% vermicompost	15.4***	10.9***	2.3***	17.3***
V <sub>4</sub> - 30% vermicompost	16.3***	12.5***	2.4***	20.8***
	LD <sub>5%</sub> = 0.3 cm LD <sub>1%</sub> = 0.5 cm LD <sub>0.1%</sub> = 0.8 cm	LD <sub>5%</sub> = 0.3 pcs. LD <sub>1%</sub> = 0.5 pcs. LD <sub>0.1%</sub> = 0.8 pcs.	LD <sub>5%</sub> = 0.1 pcs. LD <sub>1%</sub> = 0.2 pcs. LD <sub>0.1%</sub> = 0.3 pcs.	LD <sub>5%</sub> = 0.4 pcs. LD <sub>1%</sub> = 0.7 pcs. LD <sub>0.1%</sub> = 1.1 pcs.

Mean number of main roots varied between 12.5 roots/plant and 20.8 roots/plant at variants with vermicompost, face to 8.3 roots/plant at control, and mean number of stems' ramifications was between 2.1 ramifications/plant and 2.4 pcs./plant, face to 1.1 ramifications/plant at  $V_1$  (tab. 3).

After statistical interpretation regarding seedlings' features before planting in field was observed that at seedlings' mean height, also as mean number of leaves per plant, mean number of main roots and ramifications number, differences face to control  $V_1$ , at all variants with vermicompost were very positive significant (tab. 3).

## CONCLUSIONS

Vermicompost influence germination onset, germination duration, as well as germination process at *Ocimum basilicum*.

Vermicompost helps mainly at plants' roots development.

Statically speaking, characteristics of seedlings before planting in field, regarding mean seedlings height, mean number of leaves per plant, mean number of main roots and ramification number, recorded face to control very significant positive differences, at all variants with vermicompost.

Seedlings with the best quality were obtained when in substrate was a rate of 30% vermicompost ( $V_4$ ).

## REFERENCES

1. **Birendra Kumar, 2012** - *Prediction of germination potential in seeds of Indian basil (Ocimum basilicum L.)*. Journal of Crop Improvement, vol. 26, issue 4, p. 532-539
2. **Chelariu Elena-Liliana, Ghiorghe C., 2017** - *Influence of vermicompost on seedlings obtaining at some species of ornamental grasses*. Lucrări științifice USAMV Iași, seria Horticultură, vol. 60. ISSN:1454-7376
3. **Jelačić Slavica, Lakić Nada, Beatović D., Vujošević Ana, 2005** - *Effects of different substrates on basil seedlings quality (Ocimum basilicum L.)*. Journal of Agricultural Sciences, vol. 50, issue 2, p. 107-115
4. **Kalra A., Chandra M., Awasthi A., Singh A.K., Khanuja S.P.S., 2010** - *Natural compounds enhancing growth and survival of rhizobial inoculants in vermicompost-based formulations*. Biol. Fertil. Soils, vol. 46, p. 521–524
5. **Mathivanan S., Chidambaram Al., Sundaramoorthy A.P., Kalaikandhan R., 2012** - *Effect of vermicompost on germination and biochemical constituents of ground nut (Arachis hypogaea L.) seedling*. Int. J. Res. Biol. Sci. vol. 2, issue 2, p. 54–59
6. **McGinnis M.S., Warren L., Bilderback T.E, 2004** - *Effect of vermicompost amended pine bark on basil production*, Container-Grown Plant Production, Sna Research Conference, vol. 49, p. 120-123
7. **Ramin A.A., 2006** - *Effects of Salinity and Temperature on Germination and Seedling Establishment of Sweet Basil (Ocimum basilicum L.)*. Journal of Herbs, Spices and Medicinal Plants, vol. 11, issue 4, p. 81-90
8. **Singh B.K., Pathak K.A., Verma A.K., Verma V.K, Deka B.C., 2011** - *Effects of vermicompost, fertilizer and mulch on plant growth, nodulation and pod yield of French bean (Phaseolus vulgaris L.)*. Vegetable crops research bulletin, vol. 74, p. 153-165
9. **Suthar S., Choyal R., Singh S., Sudesh R., 2005** - *Stimulatory effect of earthworm body fluid (vermiwash) on seed germination and seedling growth of two legumes*. J. Phytol. Res. 1(2), p. 219–222

## PRELIMINARY STUDIES REGARDING THE USE OF VEGETABLE SPECIES IN THE CONCEPT OF URBAN GARDENS

### STUDII PRELIMINARE PRIVIND UTILIZAREA SPECIILOR LEGUMICOLE ÎN CONCEPTUL GRĂDINILOR URBANE

HANGAN (ISTRATE) Ana-Maria-Roxana<sup>1\*</sup>, GACHE (LUNGU) Mirabela<sup>1</sup>,  
TELIBAN G.C.<sup>1</sup>, STOLERU V.<sup>1</sup>

\*corresponding author: roxanah@uaiasi.ro

**Abstract.** *This paper presents a literature preview regarding the use of vegetable species in the concept of urban gardens. The designing of the utilitarian gardens dates back from the antiquity when they were particularly important as a source of food. With the emergence of the concept of "edible landscaping", which promotes the use of edible plant species along with ornamental plant species in landscaping, the utilitarian garden has acquired aesthetic valences as an integral part of the green space set up on private property in the urban area and not only. Starting from the desire of people to have a place to produce some of the necessary vegetables and aromatic plants in the small space around the houses and to enjoy a recreation space, will be studied different systems of use of vegetable plants in order to develop concrete measures for the development of decorative vegetable gardens in the private environment in urban and periurban areas, taking into account the possibilities of association of the leguminous plants in raised beds.*

**Key words:** *Urban garden, Edible landscape, Vegetable garden*

**Rezumat.** *Lucrarea prezintă o sinteză a literaturii de specialitate referitoare la posibilitățile de utilizare a speciilor legumicole în conceptul grădinilor urbane. Amenajarea de grădini utilitare datează din antichitate când acestea prezentau importanță mai ales ca sursă de hrană. Odată cu apariția conceptului de „edible landscaping”, ce promovează utilizarea unor specii de plante comestibile alături de specii de plante ornamentale în amenajările peisagistice, grădina utilitară a căpătat valențe estetice devenind parte integrantă a spațiului verde amenajat pe proprietățile private din mediul urban și nu numai. Plecând de la dorința oamenilor de a avea un loc în care să își producă o parte din necesarul de legume și plante aromatice în spațiul restrâns din jurul caselor și de a beneficia totodată de un spațiu de recreere se vor studia diferite sisteme de utilizare a plantelor legumicole în vederea elaborării unor măsuri concrete de dezvoltare a grădinilor decorative de legume în mediul privat din zonele urbane și periurbane, ținând cont de posibilitățile de asociere a plantelor legumicole în strat înălțat.*

**Cuvinte cheie:** *grădină urbană, grădină utilitară, amenajare, plante legumicole*

---

<sup>1</sup>University of Agricultural Sciences and Veterinary Medicine of Iasi, Romania

## INTRODUCTION

The attractiveness and value of landscaped designed areas are generated by their capacity to meet the needs of urban comfort and quality of life in general. The value of a harmonious landscaping design also resides in its educational effect, because the environment created by the design can enhance the aesthetic sense of the inhabitants.

The designing of the utilitarian gardens dates back from the antiquity when they were particularly important as a source of food. With the emergence of the concept of "edible landscaping", which promotes the use of edible plant species along with ornamental plant species in landscaping, the utilitarian garden has acquired aesthetic valences as an integral part of the green space set up on private property in the urban area and not only (Creasy, 1984).

More and more people adopt the concept of ornamental vegetable gardens in their gardens. There are many reasons why people are trying to integrate vegetable and aromatic plants into the landscape around the house. One of these reasons is that not everyone has an area large enough to create a classic vegetable garden.

Starting from the desire of people to have a place to produce some of the necessary vegetables and aromatic plants in the small space around the houses and to enjoy a recreation space, will be studied different systems of use of vegetable plants in order to develop concrete measures for the development of decorative vegetable gardens in the private environment in urban and periurban areas, taking into account the possibilities of association of the leguminous plants in raised beds. The ornamental value and location of plants will play a very important role in creating the entire design.

## MATERIAL AND METHOD

The main research methods used are documentary study and case study regarding the situation of vegetable gardens over time and observation on species growth and development in raised beds.

In order to understand the growth and cultivation of plants in high elevations, a study will be carried out on the types of ornamental vegetables gardens and their purpose.

Another important factor in this study is how to design the vegetable garden. In order to design a vegetable garden, the area and site for the design will be assessed and natural factors such as soil, light, water and local fauna will be taken into account.

## RESULTS AND DISCUSSIONS

The cultivation technology of the vegetable species allows different associations between them for an intense, good and calculated importance of the fields on which they are cultivated on thus, allowing it to be used for a long period of time by practicing allotment system, whether it is a household garden or a vegetable specialty farm (Bird, 2008).

In order to ensure a gradual production and for the most intensive use of the space, successive and intercalated crops will be realized, the latter increasing the ornamental potential of the design by juxtaposing complementary species such as colour, shape and texture of the leaves or habitus.

Due to the fact that a garden must have a decorative effect over the whole year, it must be designed in such a way that the species proposed for association and succession present elements whose aesthetic characters are amplified and adapted to each season (Creasy, 2010).

The ornamental-utilitarian vegetable garden is divided in three types of vegetable gardens: the vegetable garden, the aromatic plants garden and the kitchen garden or “jardin potagere”.

For vegetable gardens, which focus more on the utility than the aesthetic, a geometric compositional scheme is chosen, which is more suitable for production and plant care (fig. 1).

The aromatic plants garden is a separate space of the main garden with purpose is growing aromatic plants and medicinal plants. It can be carefully designed after geometric patterns or to a more natural scheme, with an unorganized, random appearance (fig. 2) (Kourik, 1986).



**Fig. 1** – The utilitarian vegetable garden([www.gedeus.ro/legume-ierburi-aromate-amenajari-gradini](http://www.gedeus.ro/legume-ierburi-aromate-amenajari-gradini))



**Fig. 2** – Knot garden([www.gedeus.ro/legume-ierburi-aromate-amenajari-gradini](http://www.gedeus.ro/legume-ierburi-aromate-amenajari-gradini))

The purpose of the kitchen garden is to combine the utilitarian and the aesthetic function. In this garden aromatic plants and vegetables plants are combined with floral plants to enhance the aesthetic effect. Also for aesthetic reasons are used ornamental varieties of utility plants (variegated sage, decorative cabbage etc.) (fig. 3).



**Fig. 3** Kitchen garden([www.gedeus.ro/legume-ierburi-aromate-amenajari-gradini](http://www.gedeus.ro/legume-ierburi-aromate-amenajari-gradini))

The first step in designing a garden is setting the goals. These goals are to determine the type of garden, the amount of time that will be allocated to care, and the choice of the right plants (Mihai, Hoza, 2012).

### **Designing types of the ornamental-utilitarian vegetable gardens**

#### *1. Classical vegetable gardens*

Planting in classical gardens is done in the existing soil (fig. 4). This type of gardening is suitable for most plant types, does not require special maintenance, and initial investment is minimal. It is important that the surface soil be of good quality (60 cm deep), be effectively drained and cleaned by the roots of nearby trees for optimal plant development (Creasy, 2010).

#### *2. Raised bed vegetable garden*

This is a form of gardening, in which stands are created above ground level. They can be of various shapes, bounded by wooden, stone, or concrete curbs (fig. 5).

The plants are closer than in the classic garden. Their spacing is such that when they reach maturity, they create a microclimate where weed growth is suppressed and moisture is preserved (Creasy, 1984).

This type of design has many benefits: extend the growing season, reduce weeds, if properly designed and planted, are very productive.



**Fig.4** Classical vegetable gardens  
([www.edifica.ro/despre-gradina/gradina/alegeti-stilul-pentru-gradina-de-legume/](http://www.edifica.ro/despre-gradina/gradina/alegeti-stilul-pentru-gradina-de-legume/))



**Fig.5** Raised bed vegetable garden  
(original)



### 3. *Lasagna garden*

This is an elevated garden type, built on the surface of existing soil from several layers of organic material, hence the name lasagna. Materials may vary but usually include cartons, organic fertilizers, straw, green waste and compost. This type of garden is ideal if the soil is not suitable for gardening (fig. 6).

### 4. *Pots and containers garden*

There can be a very productive garden even on a small piece of land. The gardens in pots and containers are ideal for apartments because they rely exclusively on crops in pots, vases and other small containers (fig. 7). Also included are the vertical gardens or green walls that are created by vertically disposing containers (including paper or textile pockets) (Creasy, 2010).



**Fig.6** Lasagna garden  
([www.edifica.ro/despre-gradina/gradina/alegeti-stilul-pentru-gradina-de-legume/](http://www.edifica.ro/despre-gradina/gradina/alegeti-stilul-pentru-gradina-de-legume/))



**Fig.7** Pots and containers garden  
([www.edifica.ro/despre-gradina/gradina/alegeti-stilul-pentru-gradina-de-legume/](http://www.edifica.ro/despre-gradina/gradina/alegeti-stilul-pentru-gradina-de-legume/))

### 5. *Wicker bed gardens*

Wicker beds are layers made of large containers containing a water tank at the bottom. The water circulates in the bottom-to-top container through capillarity.

Wicker beds can be easily made from polystyrene containers. Any elevated garden can be designed with this irrigation system (fig. 8).

Essentially, this is a combination of the raised garden and the container garden (Kourik, 1986).





**Fig. 8** Wicker bed gardens ([www.edifica.ro/despre-gradina/gradina/alegeti-stilul-pentru-gradina-de-legume/](http://www.edifica.ro/despre-gradina/gradina/alegeti-stilul-pentru-gradina-de-legume/))

## CONCLUSIONS

1. Plant cultivation has been an integral part of human history since ancient times. The man's need to feed led to the appearance of the garden as a source of fast and safe food that man could rely on. Therefore, the garden initially had an utilitarian role, the production of food and medicinal plants being its main purpose;

2. Five types of vegetable gardens were identified: the classic vegetable garden, raised beds vegetable garden, the lasagna garden, pots and container gardening, the garden with wicker beds.

3. In order to design a vegetable and aromatic plants garden, there are a few steps to follow: to assess the area where the garden is planned, to set the main objectives and to plan the project.

## REFERENCES

1. Bird R., 2008 – *Cultivarea fructelor si a legumelor*. Editura Aquila, București.
2. Creasy R., 1984 – *The Complete Book of Edible Landscaping*. Random House Value Pub.
3. Creasy R., 2010 – *Edible Landscaping*. Sierra Club Books.
4. Kourik R., 1986 – *Designing and maintaining your edible landscape naturally*. Metamorphic Press.
5. Mihai C., Hoza G., 2012 – *Researches regarding the productive and ornamental characteristics of vegetable growing in utilitarian gardens*. Scientific Papers, Series B, Horticulture, Vol. LVI.
6. \*\*\*[www.gedeus.ro/legume-ierburi-aromate-amenajari-gradini](http://www.gedeus.ro/legume-ierburi-aromate-amenajari-gradini)
7. \*\*\* [www.edifica.ro/despre-gradina/gradina/alegeti-stilul-pentru-gradina-de-legume](http://www.edifica.ro/despre-gradina/gradina/alegeti-stilul-pentru-gradina-de-legume)

## EVALUATION OF DIFFERENT METHODS FOR DRYING OF *ERYNGIUM PLANUM* AND *ECHINOPS RITRO* FLOWERS

### EVALUAREA DIFERITELOR METODE DE USCARE A FLORILOR DE *ERYNGIUM PLANUM* ȘI *ECHINOPS RITRO*

MORARU Mihaela<sup>1\*</sup>, BRÎNZĂ Maria<sup>1</sup>,  
CHELARIU Elena Liliana<sup>1</sup>, DRAGHIA Lucia<sup>1</sup>

\*Corresponding author e-mail: mihaela1504@yahoo.com

**Abstract.** The plants of the genres *Eryngium* and *Echinops* assume distinctive ornamental qualities, being appreciated both in landscaping design and in floral art. In this paper are presented results regarding the drying of cut flowers obtained from *Eryngium planum* and *Echinops ritro*, with the purpose of utilization as immortelles. The drying of the inflorescences was achieved by two methods, respectively, simple drying in the dark and using a desiccant (silica gel). The results obtained show that for both species, the drying time is shorter and the water is eliminated in a higher percentage when using silicate. *Eryngium* inflorescences dried with silica gel have more intense blue tone; at *Echinops ritro* have been obtained the immortelles with similar aesthetic features with both drying methods.

**Key words:** *Eryngium*, *Echinops*, dried flowers, desiccant

**Rezumat.** Plantele din genurile *Eryngium* și *Echinops* au calități ornamentale deosebite, fiind apreciate atât în amenajarea grădinilor, cât și în arta florală. În lucrarea de față sunt prezentate rezultate privind uscarea florilor tăiate recoltate de la *Eryngium planum* și *Echinops ritro*, în vederea valorificării lor ca imortele. Uscarea inflorescențelor s-a realizat prin două metode, respectiv uscarea simplă la întuneric și prin folosirea unui desicant (silica gel). Rezultatele obținute arată că, la ambele specii, durata de uscare este mai scurtă și cantitatea de apă eliminată este mai mare, atunci când uscarea se face în silica gel. Inflorescențele de *Eryngium* uscate în silica gel au avut culoarea albastru mai intens; la *Echinops ritro* s-au obținut imortele cu însușiri estetice asemănătoare, prin ambele metode de uscare.

**Cuvinte cheie:** *Eryngium*, *Echinops*, flori uscate, desicant

## INTRODUCTION

In recent years, *Eryngium* and *Echinops* species are increasingly found in gardens, where they decorate in summer, autumn and winter, through dry inflorescences. Also, these plants have become more and more appreciated as cut flowers, used in floral workshops in compositions of arrangements and bouquets, due to their color and appearance, but also for the time resistance of floral stems (Armitage, 1993).

In floral compositions, the use of *Eryngium* cultivars is increasingly being used due to the unique appearance of the inflorescences and the effect they offer

<sup>1</sup>University of Agricultural Sciences and Veterinary Medicine Iasi, Romania

in arrangements. Although used with a secondary role in floral creation, they often become the center of attraction in compositions (Everett, 1960).

The plants of *Eryngium* and *Echinops* are considered to be immortelles by adoption because they retain their shape and color after drying. For long-lasting floral stems, it is recommended to dry in the dark, in well-ventilated rooms or with a desiccant (Armitage, 1993).

## MATERIAL AND METHOD

The experiments took place in 2017, in the laboratory of Floriculture, at the University of Agricultural Sciences and Veterinary Medicine from Iasi, Romania. The floral material used in the experiment is the inflorescences of the *Eryngium planum* and *Echinops ritro* species and the methods of drying the material are by the classical method (in the dark) and by means of a desiccant (silica gel).

*Eryngium planum* presents glaucous leaves, pale blue flowers grouped in umbels and it blooms from July to August.

*Echinops ritro* is a perennial species that reaches heights between 40-60 cm. Leaves are simple, green; the flowers are grouped in spherical inflorescences, blue color, and it blooms from July to September.

Uses of *Echinops* and *Eryngium* species can be in dry state, because the flowers maintains its characteristics after drying. For drying, the optimal harvest time (fig. 1) is in colorful bud stage (Ellis, 2000).



**Fig. 1** Optimum harvest time for *Eryngium planum* (a) and *Echinops ritro* (b) (original)

The classic method of drying is considered an effective and easy to implement, drying of inflorescences with the top down, into dark and in well-ventilated rooms. It is important that immortelles are not exposed to light during the drying process, because some decorative parts are discolored, resulting in poor quality finishing materials. It is recommended that bouquets meant to be dried are made up of few threads to avoid the risk of pressing. Their positioning with the tip down is also important if a right flowering rod is ultimately followed (Draghia and Chelariu, 2011).

The silica gel is also used for drying flowers because it absorbs moisture quickly and keeps colors better than other drying methods. Drying must be done in closed containers so that the silicate does not absorb the humidity in the atmosphere, which can lead to delayed drying of the flowers (Smith *et al.*, 1998). Inflorescences were harvested from plants in colorful bud phase plants, in dry time, at noon.

Experimental factor is the drying method:  $V_1$  - dark drying;  $V_2$  - silica gel drying. The plants were considered dry when, after weighing, they kept their constant weight.

The parameters observed were: influence of both methods on drying time, expressed in days from harvest to drying of inflorescences; influence of drying methods on the percentage of water eliminated daily after drying.

## RESULTS AND DISCUSSIONS

The difference between the drying time by classical method and the silicate versus the average of the experience is about 2 days. Dried plants in the dark were conserved with 27.87% later than the average of the experience, while those dried with silicate dried with 26.63% faster (tab. 1). The silicate method has the advantage of a faster drying time of cut flowers, with 3 days compared to the drying method in the dark.

Table 1

Influence of methods for preserving on cut flowers of *Eryngium planum*

Variant (preservation solution)	Drying (no. of days)		Differences (± days)	Significance of differences
	Absolute value	Relative value (%)		
$V_1$	7.8	127.83	1.65	**
$V_2$	4.5	73.17	-1.65	oo
<b>Average (control)</b>	6.15	100.00	-	-
				LSD 5% = 0.8 LSD 1% = 1.5 LSD 0.1% = 3.2

Following the experiments on the drying of *Echinops ritro* plants (tab. 2) by the two methods: in the dark, in a well-ventilated room and with the help of silicate, it can be noticed that the drying time is lower in the case of the immortelles obtained with crystals of silica gel (13.5 days) than in the dark (16.5 days). Compared to the average of experience, both methods record a difference of 1.5 days.

Table 2

Influence of preserving methods on cut flowers of *Echinops ritro*

Variant (preservation solution)	Drying (no. of days)		Differences (±days)	Significance of differences
	Absolute value	Relative value (%)		
$V_1$	16.5	110.00	1.5	*
$V_2$	13.5	90.00	-1.5	o
<b>Average (control)</b>	15.0	100.00	-	-
				LSD 5% = 1.3 LSD 1% = 2.4 LSD 0.1% = 5.3

The advantage of drying *Eryngium planum* plants with silicate is to keep the color blue, in a toner more intense compared with dried flowers obtained by the classic drying method (fig. 1). Another advantage is the intact form of the bracts, compared to the classic drying where they are not as aesthetic.



a) b)  
**Fig. 2** Plants of *Eryngium planum* after drying: a-dark drying, b-silicate drying

Differences between the dried flowers of *Echinops ritro* obtained by the two methods are minimal in their aesthetic aspect. The only aspect is in the foliage that it is more aesthetically dried in desiccant than in the dark, as its shape has been preserved (fig. 3). The color of the inflorescences was retained by both drying variants, as well as the globular form.



a) b)  
**Fig. 3.** Plants of *Echinops ritro* after drying: a) dark drying; b) silicate drying

In the drying process the plants remove the water from the tissues and the esthetically appropriate immortelles can be obtained in a shorter time with the help of a suitable drying method.

The percentage of water lost through the silicate method is higher than the conventional method by 2.7% and the average of the experience by 1.4% (tab. 3).

Table 3

**Influence of preserving methods on the daily water loss percentage of *Eryngium planum***

Variant (preservation solution)	% of every day water loss	Differences ( $\pm\%$ )	Significance of differences
V <sub>1</sub>	4.8	-1.35	oo
V <sub>2</sub>	7.5	1.35	**
<b>Average (control)</b>	6.15	-	-
			LSD 5% = 0.6
			LSD 1% = 1.2
			LSD 0.1% = 2.6

The classical method records differences compared to the average of the experience, distinct significant in the negative sense having a more reduced percentage with 1.3% (tab. 3).

Drying in the dark for the *Echinops* floral stems brought with it the loss of water in the lowest percentage (tab. 4), recording values that are distinct significant in the negative sense, otherwise for plants whose drying was achieved with desiccant silica gel, showing positive differences of 0.2% compared to the average of the experience.

Table 4

**Influence of preserving methods on the daily water loss percentage of *Echinops* *ritro***

Variant (preservation solution)	% of every day water loss	Differences ( $\pm\%$ )	Significance of differences
V <sub>1</sub>	2.6	-0.25	oo
V <sub>2</sub>	3.1	0.25	**
<b>Average (control)</b>	2.85	-	
			LSD 5% = 0.1
			LSD 1% = 0.2
			LSD 0,1% = 0.5

The plants of *Eryngium* and *Echinops* (fig. 4) can be used in floral workshops with a secondary role in the design of arrangements, vegetal pictures, bouquets with fresh cut flowers, roses and other preserved flowers, fruits or other auxiliary materials (branches, forests, lichens etc.).



**Fig. 4** Valuation of *Eryngium planum* floral stems in dry condition (original): a) combination with preserved roses; b) association with preserved roses and lichens; c) association with fresh, dried flowers and fruits

Due to the color and shape of *Echinops* inflorescences, it can be successfully used as a secondary role in the composition of rustic floral



arrangements. Bouquets and floral arrangements containing these types of flowers are associated with flowers in similar colors or shades in contrast (fig. 5).



**Fig. 5** Valuation of flowering *Echinops ritro* stems in dry condition (original): a) association with preserved roses; b) association with preserved roses and fruits; c) association with fresh flowers and fruits

## CONCLUSIONS

1. The drying time of *Eryngium* and *Echinops* plants is shorter when using silicate than drying in the dark.

2. *Eryngium* floral stems dried with desiccant silica gel resulted in a more intense blue tone than dried by classical method.

3. The form of bracts for *Eryngium planum* was better preserved in silicate containers.

4. In *Echinops ritro* have been obtained the immortelles with aesthetic features similar to both drying methods.

5. Water is eliminated in a higher percentage, in a shorter time for both *Eryngium planum* and *Echinops ritro*, with the use of the silica gel.

6. The immortelles obtained both from *Echinops ritro* and *Eryngium planum* are special ornamental materials for the realization of dried floral compositions.

## REFERENCES

1. Armitage A., 1993 - *Specialty cut flowers*. Varsity Press. Timber Press. Portland, Oregon.
2. Draghia Lucia, Chelariu Elena Liliana, 2011 - *Floricultură*. Editura Ion Ionescu de la Brad, Iasi
3. Ellis Barbara, 2000 - *Taylor's Guide to Growing North America's Favorite Plants: proven, perennials, annuals, flowering trees, shrubs & vines for every garden*. Houghton Mifflin Harcourt.
4. Everett T.H., 1960 - *New Illustrated encyclopedia of gardening unabridged*. Vol. Greystone Press, New York.
5. Smith R., Laschkewitsch B., 1998 - *Methods of Preserving Flowers*. NDSU Extension Service, North Dakota State University Fargo, North Dakota.

## WORKFLOWS USED IN DESIGN OF THE DECORATIVE ELEMENTS FROM A GARDEN

### FLUXURI DE LUCRU UTILIZATE ÎN PROIECTAREA ELEMENTELOR DECORATIVE DINTR-O GRĂDINĂ

PRUNĂ L.<sup>1</sup>, SLONOVSKI A.<sup>1\*</sup>

\*Corresponding author e-mail: andreislonovschi@yahoo.com

**Abstract.** *When the computer program Inventor is used in order to design decorative and non-decorative elements from a garden, some workflows can be used and, is very useful to be known which workflow is properly in the given case. Starting from this, the authors made a comparative study, explained bellow, between these workflows, analyzing, step by step, each of them. Following this study, they arrived to some conclusions and recommendations, presented in the end of this paper, which are useful to follow in the case that is necessary to be chosen one workflow or other.*

**Key words:** workflows, assemblies, Inventor

**Rezumat.** *Atunci când pentru proiectarea elementelor decorative și non-decorative dintr-o grădină este folosit programul de calcul Inventor, pot fi utilizate anumite fluxuri de lucru și este foarte util să se știe care este fluxul de lucru corespunzător în cazul dat. Pornind de la aceasta, autorii au făcut un studiu comparativ, explicat mai jos, între aceste fluxuri de lucru, analizând, pas cu pas, fiecare dintre ele. În urma acestui studiu, ei au ajuns la câteva concluzii și recomandări prezentate în finalul acestei lucrări, care sunt utile pentru a fi urmate în cazul în care este necesar să se aleagă un flux de lucru sau altul.*

**Cuvinte cheie:** fluxuri de lucru, ansamble, Inventor

## INTRODUCTION

The Autodesk Inventor software may be used for the design of the decorative and non-decorative elements from a garden. There are, at least, three good reasons to use Autodesk Inventor for such type of tasks. The first reason, is for the fact that the elements which are made from timber can be easily designed into files with the extension "ipt", meaning in files type that are named "part". So, any element that is made from timber may have any shape wanted by the designer and, during the design process, if it is necessary, he can be modified whenever the engineer wants. More than that the Autodesk Inventor offers even the necessary resources to represent and colour the element which are designed, at a certain time, according to the type of wood which will be used to obtain him (Tickoo, 2015; Waguespack, 2014). For example, the Material Library of this software gives the possibility to represents and colour the element, in the case of using of the next types of wood: birch, cherry, maple, oak and walnut (fig. 1).

---

<sup>1</sup>"Gheorghe Asachi" Technical University of Iași, Romania





**Fig. 1** The types of woods texture and colour

The second reason is related to the capacity of the Autodesk Inventor program, to generate and use so called iParts. These special parts are different from the other ones "in that they are essentially table-driven part factories" (Waguespack, 2014). Each iPart generates individually derived that are not editable. When an iPart is inserted into an assembly, a dialog box appears and the user can choose, from the table showed, a variation of the original part (Waguespack, 2014). So, is very easy to be modified the dimensions and even the aspect of a final product, of an assembly in fact, when iParts are available.

The third reason deals with the fact that Autodesk Inventor offers the possibility to the users, to insert, from so called Content Center, predefined volumes having different shapes in section, such as: rectangle, trapeze and so on. These special volumes constitute a great advantage when, in the design process, the time comes to design tenons on the specified parts (Waguespack, 2014)

In addition, it could be discussed other aspects like the using of some add-ons such as Woodwork for Inventor which transforms the Autodesk Inventor in a very powerful tool whose purpose is to offer the possibility to the engineers to easily design complex furniture from different materials, (Widom, 2013; Autodesk Inventor 2016 Learn by doing, 2015). But, an add-on like this involves additional costs and is warranted only in case that the majority of orders are original and need to be designed from scratch.

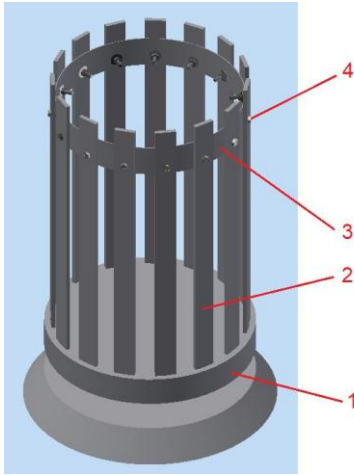
When the methodology of elaboration of a category of assemblies, by using the Autodesk Inventor software, is discussed it is mandatory to be established, among other, which workflow is better to be used. There are three categories of workflows: Bottom-Up (BU), Top-Down (TD) and Middle-Out (MO) (Tickoo, 2015). Therefore, the authors of this paper, made a study to establish which one of these workflows is better to be used when decorative and non-decorative elements from a garden are designed.

## MATERIAL AND METHOD

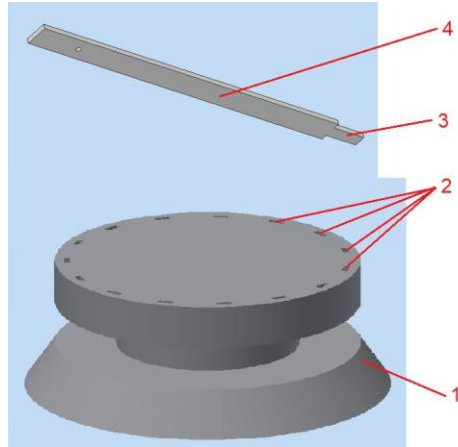
For this comparative study it was chosen, a very simple element, a basket for garbage. The parts in his composition are: the basket-base, the lath, the iron ring and a sub-assembly make from a bolt, a nut and a washer (fig. 2). This element contain two types of assembling: tenon - mortise and bolt - washer - nut which are the most common joints which are meet in the case of the decorative and non-decorative elements from a garden (fig. 3).

First was tested the Bottom-Up method. Each component was generated in separated file, like part. The shape and the dimension of each part were carefully designed. Then was open an assembly file and each part was inserted using the

Place function.

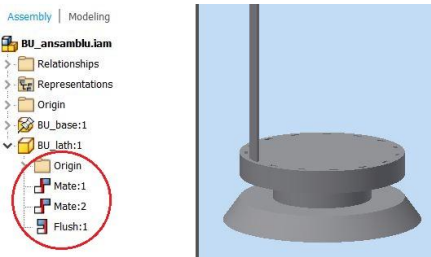


**Fig. 2** The basket for garbage, 1 – basket base, 2 – lath, 3 – iron ring, 4 – bolt, washer, nut

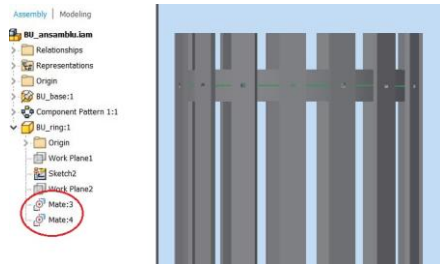


**Fig. 3** The tenon-mortise joint, 1 – basket base, 2 – mortise, 3 – iron ring, 4 – lath

The use of constraints was compulsory during the assembly creation (Hansen, 2017; Autodesk Inventor 2016 Learn by doing, 2015) Therefore, in the case of assembling tenon - mortise it was necessary to be identify three constraints, two of them are the *mate* type and one is the *flush* type (fig. 4). In order to place the ring to his place and to put him in a correct position in relation to the holes, it was necessary only two constraints, both are the *mate* type (fig. 5).



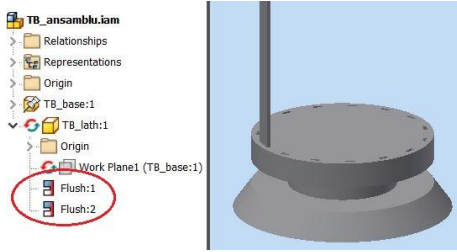
**Fig. 4** The assembling tenon - mortise requires three constraints



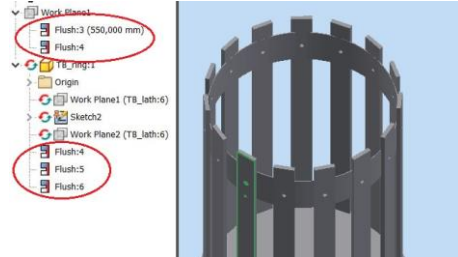
**Fig. 5** The correct positioning of the ring requires two constraints

The Top-Down workflow was tested second. In an assembly file the base of the basket was first build. Then, by using the Create function were designed, one at time, the lath and the ring. During the building of the base, the dimensions of the mortise were established whit great care. The building of the lath started from that section that was to play the role of the tenon. The tenon was designed directly, in the right position, in mortise and after that the rest of the lath was build. During this process the computer program automatically determined only two constraints, of the *flush* type (fig. 6). The design of the ring imposed the use of two auxiliary planes and, from this

reason the number of constraints went up to five (fig. 7) but all of these were automatically established by the Autodesk Inventor.



**Fig. 6** The Inventor automatically determined two constraints



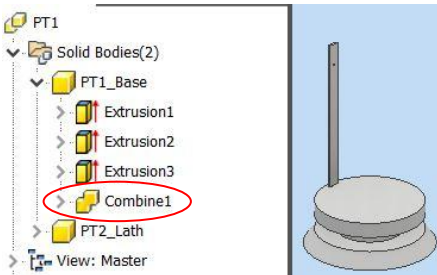
**Fig. 7** The Inventor automatically determined five constraints

In the third step the Middle-Out workflow was tested. The base and the lath were built using the Top-Down workflow and then, by the help of the function Place was added the ring, basically, the ring was inserted in the drawing, so it can be said that was used the Bottom-Up workflow. The using of this workflow reveals the same work problems encountered in the first two workflows presented at the beginning.

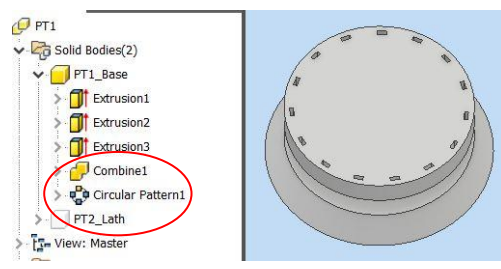
Regardless of the workflow used until now, the bolt - washer - nut assembling was made in the same way and it no presented issues which worth to be analysed.

But another one workflow can be imagined. This fourth workflow assume to design all the parts of an assembly into a file with .ipt extension and, at the end of the process, this file will be transformed in an assembly file (with the .iam extension) and all the parts which were build earlier will be automatically saved in separated files with the .ipt extension (Widom, 2013; Borodovschij, 2017). Because the authors nowhere found in literature a name for this last workflow, they named him Part - Together (PT). This workflow was also analysed.

The first thing built was the base. The second was the lath. During the base part building process the mortises were not generated. When the lath was designed, a part of him was dimensioned in such way in that it can be used like a tenon. In that point the base part has not yet the holes that play role of the mortises (fig. 8). By the using of the Combine function the first mortise was obtained. Then, the rest of the mortises were generated with the Pattern function help (fig. 9). After that, were designed all the laths and the ring. During the all process, all the pieces were generated like distinct parts which were subsequently renamed, PT\_Base, PT\_lath and so on. At the end, the Make Components function was used, and the Inventor generated an assembly file and separated files for each component previous designed.



**Fig. 8** The automatic generation of the mortise.

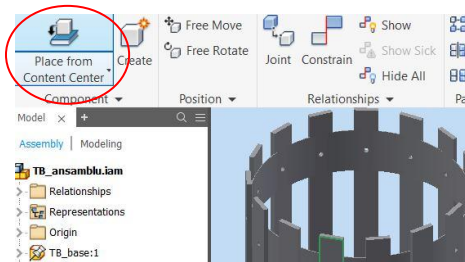


**Fig. 9** The *Pattern* function was used in order to obtained the rest of mortises

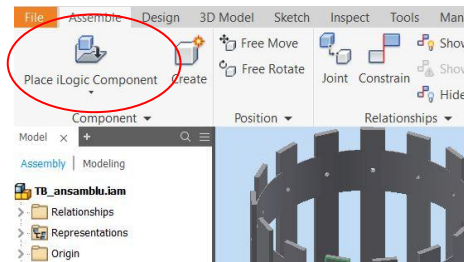
## RESULTS AND DISCUSSIONS

Analysing these workflows, the authors reached to the following results:

1. The BU workflow oblige the user to have a very clear mental image of the way that will look each part and their clear position of it in assembly. So, is mandatory to be done, a precise estimate of all dimensions, for all the parts. As consequence, the creation's effort of the image of every part and of the assembly is situated to a very high level. It can be said that the BU workflow is not intuitive and, in the same time, it is less flexible. Another disadvantage is the fact that each time a new part is inserted in the assembly it is necessary to determine the correct constraints and this operation take a lot of time. Of course, in this case, the use of the iParts can increase the level of flexibility.



**Fig. 10** The Content Center can be open and, from there, it is possible to be imported predefined parts.



**Fig. 11** It is possible to be used iParts.

2. The TD workflow is more intuitive than the BU workflow, because when a new part is created it easy to be observed the way in that this part can be fitted in the part which was created previous. So, when a part is designed, some dimensions may be established in an easy way, but for the rest of them, it is still necessary to be done a big effort. Here it is the advantage that the constraints are automatically determined by the Inventor software. Another advantage is the fact that it is possible to be used predefined parts having different shapes from Content Center (fig. 10). These parts, having so many shapes, can be used as tenons. But even in this situation is necessary to predict the shape and the dimensions of the mortises. Of course, the possibility to use iPart, like in BU workflow, could be considered like another advantage (fig. 11) A disadvantage is the fact that, in case which are used iParts, or parts anterior created, the software does not automatically determine the constraints. Another disadvantage is the fact that the Combine function doesn't work in this case.

3. The MO workflow does not bring any advantage compared to the TD workflow. Basically, is about the TD workflow when, at one moment, are inserted parts created before, predefined parts or iParts and this case was presented and analysed above.

4. The PT workflow is more intuitive than the TD workflow. The PT workflow offer not only the possibility to create a part starting from another part, by observing how they are fitting, but gives the possibility to generate some details of shape of a part by using the pair details from another part and this is possible because de Combine function may be used. In this workflow the iParts can't be used. This loss is not so important because when decorative and non-decorative elements from a garden are designed, the designers have to imagine a large variety of shapes and this make that factors like intuition and creativity to be more important than the possibility to the use of the parametric parts. Once a part was created, it is recommended to be renamed, because at the end of the creation's process, Inventor gives the possibility to save each part in a separate file by using the Make Components function. Once a part was created, it is recommended to be renamed, because at the end of the creation's process, Inventor gives the possibility to save each part in a separate file by using the Make Components function. If during of the element's design, the Pattern function is used, it is very important that this function to be set in such way in that each item of a pattern to be seen like a distinct part. Otherwise, when the Make Components function is used, the subassembly which resulting by the use of the Pattern function will be seen like a single part and will be generate a separate file with this subassembly.

## CONCLUSIONS

1. In AutoDesk Inventor software, the PT workflow is the best when come about to project decorative and non-decorative elements from a garden, because is the most flexible and intuitive workflow between the known workflows.

2. In AutoDesk Inventor software, the DT workflow may be use to project decorative and non-decorative elements from a garden, but is less flexible than the PT workflow. In this case, there is the advantage that the iPart can be used.

3. In AutoDesk Inventor software, the BU and MO workflows are not recommended be used to project decorative and non-decorative elements from a garden.

## REFERENCES

1. **Borodovschij I., 2017** – Woodwork for Inventor - V8 Capabilities, <https://www.youtube.com/watch?v=plPufySGIb4>
2. **Hansen L.S., 2017** - *Autodesk Inventor 2016 Learn by doing*, Tutorial Books, SDC Publications, USA.
3. **Tickoo S., 2015** – *Autodesk Inventor 2016 for Designers*. CAD/CIM Technologies, Schererville, Indiana, USA.
4. **Waguespack C., 2014** – *Mastering Autodesk Inventor 2015 and Autodesk Inventor LT 2015*, John Wiley & Sons, Inc., Indianapolis, Indiana, USA.
5. **Widom S., 2013** – *Autodesk Inventor – Woodworking -3 Part Tutorial Woodworking 4 Inventor 1 of 3 – All Levels*, <https://www.youtube.com/watch?v=HXiKNqBhlqQ>
6. \*\*\*\*, **2015** – *Autodesk Inventor 2016 Learn by doing*, Tutorial Books, CreateSpace Independent Publishing Platform, USA.

## POLLUTION OF THE RIPARIAN ENVIRONMENT BY THE TAZLAUL SĂRAT UPSTREAM RIVER

### POLUAREA MEDIULUI RIVERAN PE CURSUL SUPERIOR AL RÂULUI TAZLĂUL SĂRAT

AVRAM Mihaela<sup>1</sup>, LUCA M.<sup>1\*</sup>, MARCOIE N.<sup>1</sup>, LUCA AL. L.<sup>2</sup>

\*Corresponding author e-mail: mluca2015@yahoo.com

**Abstract.** *The paper presents an analysis of the pollution phenomenon in the Tazlăul Sărat River basin. The studies and researches were carried out on the upper course of the river, in the area of Zemeș locality, where there are a series of wells for oil extraction. The floods have morphologically altered the minor river bed, which has influenced the stability of the banks and river basins. Crude oil pipelines are located in the river bank. Field research has analyzed the river sector between "Toderăș" and "Canton of Maxim", which administratively belongs to the commune of Zemeș, Bacău County. The flood of June 2016 had an excessive impact on the stability of oil pipelines, a situation that caused the scrapping and suspension of the pipeline.*

**Key words:** degradation, flood, impact, oil, pipeline

**Rezumat.** *Lucrarea prezintă o analiză a fenomenului de poluare în bazinul hidrografic al râului Tazlăul Sărat. Studiile și cercetările s-au efectuat pe cursul superior al râului, în zona comunei Zemeș, unde sunt o serie de sonde pentru extracția țițeiului. Viiturile au modificat morfologic albia minoră a râului, situație ce a influențat stabilitatea malurilor și a construcțiilor riverane. În malul râului sunt amplasate conductele de transport ale țițeiului. Cercetarea în teren a analizat sectorul de râu cuprins între zonele „Toderăș” și „Cantonul lui Maxim” ce aparține administrativ de comuna Zemeș, jud. Bacău. Viitura din iunie 2016 a afectat excesiv stabilitatea conductelor pentru țiței, situație ce a determinat deplasarea decopertarea și suspendarea acestora.*

**Cuvinte cheie:** conducte, degradare, impact, petrol, viitură

## INTRODUCTION

The rivers in Romania have a hydrological regime characterized by the high frequency of the floods. In the last 15 years floods have been reported with maximum flows at intervals of two years and even annually. An example in this case is the river basin of Siret, where the frequency of floods over the last 20 years is extremely high (Avram, 2016, Vamanu and Olariu, 2003).

Natural and anthropic hydrological risk factors influence the morphology of the bed, the stability of the bed and bed constructions, and the habitat existing in the

---

<sup>1</sup>Technical University "Gheorghe Asachi" of Iasi, Romania

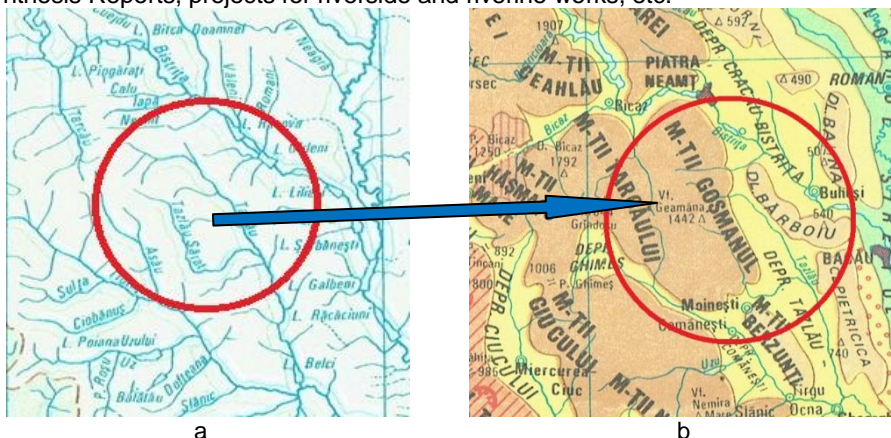
<sup>2</sup>Polias-Instal Company Iasi, Romania

minor and major river bed. Disastrous floods have caused significant degradation of the social and economic objectives of the coastal area. At the same time, these floods have caused significant degradation of the riparian environment (Avram, 2016).

A special situation is the hydrographical basin of the Tazlăul Sărat River, where the effect of the floods materialized through important degradations of the riparian environment. On the upper course of Tazlău Sarat there is a strong influence of anthropogenic risk factors (Luca, 2016). The aim of the paper is to highlight the effect of anthropogenic risk factors, intensified by the natural risk factors on the local riparian environment and along the upper course of the Tazlăul Sărat River.

## MATERIAL AND METHOD

The studies and researches were carried out on the upper sector of the Tazlăul Sărat River located in the Troțuș River Basin (fig. 1). The research material consists of hydrological, hydraulic, topographic, geotechnical, climatic, pollution studies, etc. The data used in the research come from the following sources: technical expertise in the field of regulation of rivers and shore defense constructions, A.B.A Siret Bacau Synthesis Reports, projects for riverside and riverine works, etc.



**Fig. 1** Geophysical characteristics in the study area: a - hydrographical network; b - relief areas

Part of the data comes from field research conducted by authors on the analyzed river sector (Luca, 2016). Studies and research are conducted over different periods of time.

The theoretical and experimental research was carried out in the following areas:

1. Researching hydrological and hydraulic parameters on the surface of the river basin and the river sector considered in the study.
2. Investigation of the phenomenon of pollution on the studied river sector. The parameters analyzed were: pollution sources, pollutant types, pollution areas, etc.
3. Researching the natural and anthropic risk parameters influencing the pollution phenomenon.

Primary data has been processed using the statistical, hydrological and hydraulic calculation programs applicable to the case study.

Primary data was processed using the statistical calculation programs and hydrological and hydraulic calculation programs applicable in this case study.



---

**RESULTS AND DISCUSSIONS**

The Tazlăul Sărat River, a tributary of Tazlău near the village of Tescani, has a length of 42 km and a surface of the 211 km<sup>2</sup> river basin (Ujvari, 1972). The historical flow is 284 m<sup>3</sup> / s, being registered in 2005 (fig.1).

The commune of Zemeș is located geologically in the external area of the flysch zone, where two tectonic units were separated: the Tarcău cloth and the marginal unit (the margins of the margins) and the Zemeș scabbard. In the Paleogland area, oil and natural gas are exploited. Oil accumulations are generally present in the Lucăcești sandstone, the Kliwa sandstone and the transition horizon. The oil and gas fields are grouped by productive units (about five units) in the Zemeș - Moinești area (Luca, 2016).

From the analysis of the state of the environment in the research area, for the "soil and water" environmental factors, a special situation arises for a potentially vulnerable area of the Tazlăul Sărat catchment area. This is the "Zemeș - Moinești Petroleum Area" where environmental parameters are affected by the operation of the wells and the damage from the oil installations. The main sources of pollution in the study area are:

a - transport of alluvial and wood waste is intense and polluting the riparian environment;

b - artificial sources of oil exploitation (drilling and storage extraction wells, technological fluid transport pipelines).

The pollution phenomena are represented in this area by the following:

- soil pollution with hydrocarbons in the well location area (fig. 2.a);

- hydrocarbon pollution in the location of the oil and technological fluid pipelines.

Oil pipelines have a high risk of pollution through the degradation state and the actions taken by the site (Drever, 1997). The anthropic risk factors represented by the lack of repair and maintenance work lead to corrosion, cracking, breakage and breakage of pipes (fig. 2.b). The data presented by APM Bacau in the annual reports show the environmental pollution situations in the city area of Zemeș - Moinești.

The research area located on the upper course of the Tazlăul Sărat River is influenced by a series of natural and anthropogenic risks. The most important natural hazard is of hydrological nature and is presented by "hydrological risk". This is represented by the floods on the Tazlăul Sărat River, whose influence influences the morphology of the riverbed and the configuration of the riparian area. Another natural risk, with a special influence on human communities, is the risk of landslides. The presence of landslides influences the initiation of pollution in the location of oil wells and pipes.

Out of the anthropogenic risks, there are three outliers that significantly influence the living conditions of the human community as well as environmental quality parameters. The three anthropic risks are:

- the anthropic risk associated with the maintenance and repair of the hydro-technical works on the river Tazlăul Sărat and its tributary network;





**Fig. 2** Sources of soil and water pollution in the Tazlăul Salat river basin: a - oil extraction wells; b - pipelines for the transport of technological products (photo oct 2016).

- the anthropic risk represented by the action of the constructions and the oil exploitation installations in the Zemeș - Moinești area;
- the anthropic risk represented by the absence of work to regulate the surface runoff and depth of groundwater, a situation that favours landslides.

The research carried out in the area of Bolătău locality, Zemeș commune, in the Tazlăul Sărat riverbed and in the riparian area, revealed the way of the floods in the river degradation. In this area, the river features a meandering bed, and at the contact with the DC 180A communal road a short length of defence was executed.



**Fig. 3** The degradation of the oil transport pipelines in the Bolătău area after the flood in June 2016 on the Tazlăul Salat River: a - upward view of the pipeline position; b - downstream view (shoreline at DC180A with pipe stripping, photo oct 2016).

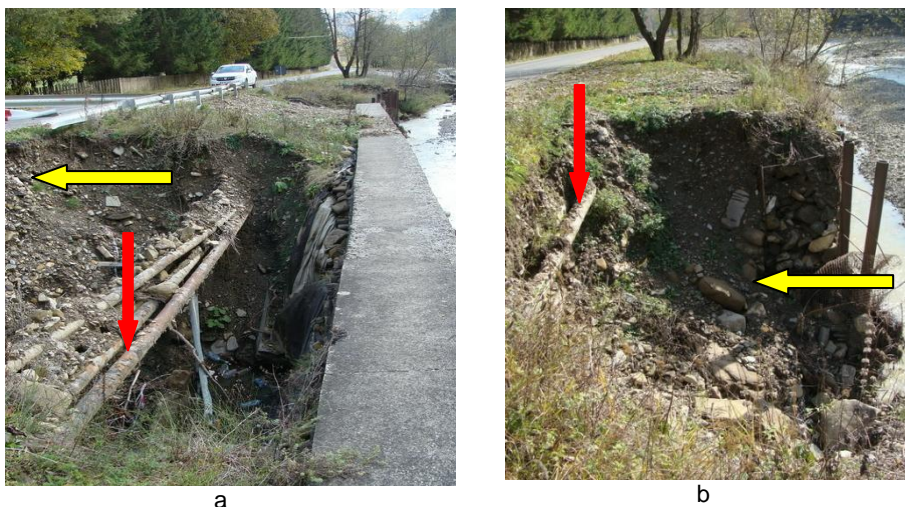
The river develops a large hydraulic energy in the curve area, especially in times of flood, which generates a high-value hydrodynamic force acting on shoreline and shoreline construction. The unprotected bank of the river was eroded on a length of 80 m and on a depth of 0.5-5.0 m in the bank and further on the road (fig. 3).

Oil pipelines and technological fluids (eg reservoir water) are located on the bank of the river. The erosion of the bank at floods, as well as the flow with medium flow in the bedrock, led to the pipe stripping, suspension and corrosion under the influence of climatic factors (fig. 4). Field analysis did not reveal the presence of shoreline protection along the length of the road.



**Fig. 4** Details on the dismantling and suspension of oil pipelines located on the DC 180A limit and on the Tazlăul Sărat river bank, in the area of Bolătău locality, after the flood of June 2016: a - details on the state of the pipelines; b - pipeline movement (photo Oct 2016).

The natural risk factor, of the hydraulic type, represented by the erosion speed of the bed, has been acted on by the erosion of the bed and the lowering of the slope of the tallow under the shore foundation. In this way, the water penetrated behind the shore defence, eroded the bank and the road, uncovering the oil transport pipes (fig.5).



**Fig. 5** Degradation of the oil transport pipelines in the area of Zemeș locality after the flood in June 2016 on the Tazlăul Sărat River: a - general view of the state of the pipelines behind the shore defence at the DC 180A limit; b - erosion of shore defence and pipe stripping (Oct. 2016).

The main anthropic risk is the absence of shoreline maintenance; it causes the degradation of the oil and technological fluid pipelines. This risk is accentuated by its overlap with the hydrological risk given by the floods on the Tazlăul Sărat River (Drever, 1997). The data presented in the environmental reports show the presence of oil pollution phenomena and technological fluids in the Zemeș area, as well as in the Moinești area (APM Bacau).

The oil exploitations in the Tazlăul Sărat River basin influence the balance of the pollutants on the Trotuș River. The oil activity in the Moinești area affects the Tazlăul Sărat, Tazlău and Trotuș watercourses, as well as the groundwater in the area, through the accidental spills of oil products and salty waters. The Tazlăul Sărat River has frequent accidental pollution with petroleum products, in most cases due to the rupture of transport pipelines. Some of the oil pipelines have an out-of-service life.

## CONCLUSIONS

1. The territory of the Tazlăul Sărat River Basin is influenced by natural and anthropogenic risk factors such as floods, landslides and damages from oil pipelines from the Zemeș - Moinești site.

2. During the last 25 years there has been a series of damage to oil pipelines, which has caused pollution of the Tazlăul Sarat's land and river bed.

3. The floods produced in the years 2010-2016 on the Tazlăul Salat River have eroded the bank of the river in the area of the locality, which led to the worsening of the stability of the oil transport pipelines and creating favourable conditions for pollution of the river.

4. Anthropic risk factors increase the impact of natural risk factors in the degradation of oil pipelines located on the banks of the Tazlăul Sărat river.

## REFERENCES

1. **Avram M., 2016** - *Cercetări privind impactul factorilor de risc hidroclimatic asupra proiectării, tehnologiilor de realizare și exploatarea lucrărilor de regularizare a râurilor - Studiu de caz. Raport de cercetare 2.* Univ. Tehnică „Gheorghe Asachi” din Iași.
2. **Drever J. I., 1997** - *The geochemistry of natural waters. Surface and groundwater environments.* Prentice Hall.
3. **Luca, M., 2016** - Expertiză tehnică „Consolidare mal drum DC180a in zonele afectate de inundațiile din mai-iunie 2016, respectiv punct Toderăș, Hârtopan, Chiosa și Canton Silvic Maxim, comuna Zemeș, județul Bacău”. SC POLIAS-INSTAL Iași.
4. **Ujvari I., 1972** - *Geografia apelor României.* Edit. Științifică, București.
5. **Vamanu E., Olariu P., 2003** - *Câteva aspecte privind atenuarea viiturilor în Spațiul hidrografic Siret,* Culegere de lucrări, Sesiunea științifică anuală INHGA, București.
6. **\*\*\*, A.B.A. Siret-Bacău** - *Rapoartele de sinteză privind apărarea împotriva inundațiilor, fenomenelor hidrometeorologice periculoase, accidentelor la construcții hidrotehnice și poluărilor accidentale din județul Bacău,* pentru anii 1991, 2004, 2005, 2010, 2016.
7. **\*\*\*, A.P.M. Bacău** – *Raport anual privind starea mediului în județul Bacău (2010 - 2016).*

## CONSIDERATIONS ON THE GROUND POLLUTANT EFFECT ON DRINKING WATER CONVEYANCE PIPES

### CONSIDERAȚII PRIVIND EFECTUL POLUANT AL TERENULUI ASUPRA CONDUCTELOR DE TRANSPORT ALE APEI POTABILE

*CHIRICA Ștefania<sup>1\*</sup>, LUCA M.<sup>1</sup>, LATEȘ Iustina<sup>1</sup>*

\*Corresponding author e-mail: stefania.chirica@gmail.com

**Abstract.** *The water supply system pipe networks are made of tubes and pipes joined by sockets or welds, on which a series of fittings are placed. The construction unit interacts with the degradation factors present on site. The research has shown that the main external mechanisms of pipe degradation result from the physico-chemical properties of the site's ground and external loads. External processes, which occur on the ground, lead to the degradation of the pipe network through the appearance of micro-pores, pores, fissures or cracks. Under specific operating conditions, water emission areas can become entering pathways for pollutants from the external environment inside the pipeline, causing the contamination of the drinking water conveyed. Considering the hydro-climatic phenomena in recent years, which have put pressure on viable drinking water resources, it is necessary to identify the external sources of degradation of the pipe networks.*

**Key words:** contamination, degradation, pollutant, potability, pipe network

**Rezumat.** *Rețelele de conducte din sistemele de alimentare cu apă sunt alcătuite din tuburi și țevi îmbinate prin mușe sau suduri, pe care sunt dispuse o serie de armături. Ansamblul constructiv interacționează cu factorii de degradare prezenți în terenul de amplasament. Cercetarea efectuată a arătat că principalele mecanisme externe de deteriorare a conductelor rezultă din proprietățile fizico-chimice ale pământurilor din amplasament și din încărcările exterioare. Procesele externe, care se manifestă în teren, conduc la degradarea rețelei de conducte prin apariția de micro-pori, pori, fisuri sau crăpături. În condiții specifice de funcționare, zonele de emisie ale apei pot deveni căi de pătrundere a poluanților din mediul extern în interiorul conductei, producând contaminarea apei potabile transportată. În situația în care fenomenele hidro-climatice din ultimii ani au pus presiune pe resursele viabile de apă potabilă, este necesară identificarea surselor externe de degradare a rețelelor de conducte.*

**Cuvinte cheie:** contaminare, degradare, poluant, potabilitate, rețea de conducte

## INTRODUCTION

The ground pollutant effect is materialised both through degradation on the underground water conveyance structures and alteration of the quality parameters of potable water in pipes. The structural degradation of the pipes creates water emission areas. However, the resulting emitters can transform into entering pathways for external pollutants (Luca *et al.*, 2015).

<sup>1</sup> "Gheorghe Asachi" Technical University of Iași, Romania

Drinking water conveyance pipes can operate under pressure or by free flowing. Pressure variations in water supply systems maintain the drinking water contamination phenomena. Under normal operating conditions, drinking water is pushed out into the embedding environment through existing emitters on the pipes (pores, holes, cracks, etc.). In exceptional cases, when the system operates under very low or vacuum pressure, elements from the external environment can penetrate the pipe, contaminating the conveyed drinking water (Chirica, 2018). The situation is frequently encountered during operational procedures, as part of repair operations of the damages identified on the pipe network. Controlled drainage of water conveyance pipes creates a favourable environment for external infiltration (Luca *et al.*, 2008). Infiltrations consist of solid or liquid matter with different chemical or organic charges.

## MATERIAL AND METHOD

The material under investigation consists of the features and elements with destructive potential of terrains where potable water conveyance pipes are located. The analysis aims at identifying and quantifying the risk factors in the pipe embedding environment.

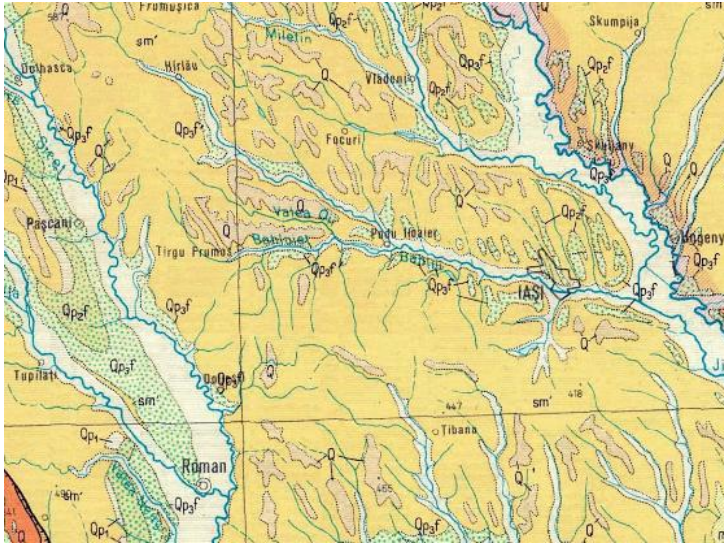
Drinking water conveyance pipes are located in environments defined by risk factors. According to the risk factors location, internal and external elements are distinguished. The embedding environment acts on the buried pipes through the nature of the rocks on site, the groundwater, landslide phenomena, ground fractures or soil liquefaction etc. Internal factors are joined by those present at the site's surface. Among these, the most frequent risk elements result from loads from traffic transmitted from the ground surface, over ground structures with a pollutant effect (domestic and industrial waste landfills etc.), agricultural areas treated with pesticides and fertilizers etc.

The research method aims to identify and analyse the characteristic ground parameters, which through the pollutant effect lead to the degradation of drinking water conveyance pipes. The risk factors in the embedding environment which manifest themselves on pipe networks influence the performance of the entire water supply system. On site degradation mechanisms are constantly evolving and lead to pipe decay. The size of the affected area evolves over time, resulting in water emission areas. At the same time, emitters can facilitate the ingress of pollutants from the outside, leading to contamination of the conveyed water.

## RESULTS AND DISCUSSIONS

Iași County is located in Moldavian Platform structural unit. The bedding of the area is represented by the Sarmatian, which consists of clays with sand layers and waterproof argillaceous marl. The deposited aquifer complexes are characterised by a high concentration of salts, being represented by sulphurous, chlor-alkali, bromo-iodine, calcic magnesian, alkaline bicarbonates waters. The Sarmatian is covered by the Quaternary. The Quaternary is characterised by a mixture of contractile loams, silty sands, followed by sandy silt, sand and gravel (Chirica *et al.*, 2018) (fig. 1).





**Fig. 1** Geological map of Iași county: Qp<sub>3f</sub> – Upper Pleistocene river deposits; Qp<sub>2f</sub> – Middle Pleistocene fluvial deposits; Q – undivided Quaternary; sm' – Extra-Carpathian Sarmatian (source: Institutul de Geologie și Geofizică, 1978)

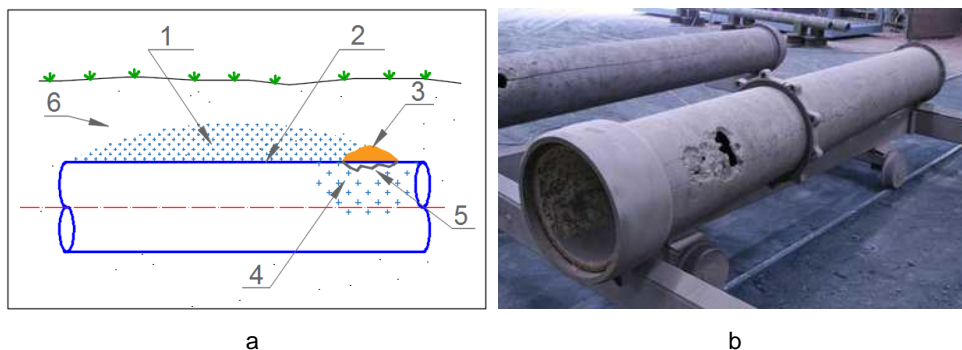
The terrain from the pipe embedding environment is made up of clayey silt, silty clays and loams with layers of clayey silts. In this situation, the land has a strong contractile character, and the likelihood of shrinkage - swelling phenomena with the humidity variation is very high. Among the properties of clays with impact on underground pipes are moisture, pH and oxygen content.

Analysis data showed that cast iron tubes are corroded in terrains with saturated or partially saturated clays. Electrochemical oxidation occurs in the presence of hydrogen peroxide. Graphical corrosion occurs as a result of the formation of a galvanic cell between the cast iron (anode) and the high conductivity embedding environment (cathode). The metal surface reacts with the oxygen and groundwater, donating electrons (Moghareh Abed, 2014).

Pipes located in clayey terrains will develop chemical corrosion areas following the development of anode surfaces with low dissolved oxygen values. When the pipe is also in contact with other ground types, more permeable, the aeration difference between the two environments leads to the emergence of a local corrosion phenomenon, only in the clay contact area (fig. 2). Cathodic surfaces develop in grounds more permeable than clay, where the dissolved oxygen content is higher than in the areas in contact with the clay.

Research has shown that acid grounds react with concrete tubes, attacking the alkaline compounds. Pipe degradation occurs as a result of cement calcium oxide neutralisation. Thus, the pH of the concrete structure will decrease and the calcium silicate will dissolve. Analysis and interpretation of data from the studies

of Jack and Wilmott (2011) and Uhlig (1963), quoted by Petersen and Melchers, show that a pH lower than 4 will amplify the corrosion process. Alkaline grounds are characterised by the presence of calcium and magnesium ions, which enable the build-up of carbonate protective layers on the surface of the pipe (Petersen and Melchers, 2012; Chirica, 2018).



**Fig. 2** Corrosion resulted from the contact with different ground types; a - schematic representation; b - corrosion on a pipe operated in an environment with different ground types (source: Petersen and Melchers, 2012; Chirica, 2018); 1 - cathodic area; 2 - increased level of dissolved oxygen; 3 - clay lump; 4 – anodic area with low dissolved oxygen; 5 - pipe corroded area; 6 - embedding environment consisting of sands.

Magnesium, sodium or calcium sulphates from terrains or groundwater have destructive potential on concrete pipes when they penetrate into their structure through pores and accumulate over time. Sulphates react with some of the concrete compounds, dissolving the cement hydration products. The ions that penetrate into the structure of the concrete form volume - enhancing products such as gypsum, which destroy the structure of the concrete (Rozière *et al.*, 2009).

The chlorides in the embedding environment attack the steel pipes, but also the reinforcement elements of the reinforced concrete pipes. In the case of reinforced concrete pipes, chlorides no longer allow the concrete to protect the reinforcement from the action of acids. Corrosion of metal surfaces will occur in the presence of oxygen on site. The greater the permeability of the concrete, the more porous, with cracks and fissures and calcium chloride in its composition, the more severe the degradation will be (American Concrete Pipe Association, 2016).

Phreatic water confined in Iași County is characterised by intense sulphatic aggressiveness and weak magnesian aggression on concrete structures, according to STAS 3349/1-83. For this reason, concrete and steel pipes will be affected by chemical corrosion phenomena. The aggressiveness of groundwater requires special corrosion protection measures for underground pipelines. Unconfined phreatic waters located in Sarmatian formations are characterised by a superior degree of mineralisation. The ground waters from Tomești, Breazu, Copou and Picioru Lupului are sulphated, sodium and magnesian. Those in Pârcovaci, Răducăneni and Strunga areas are sulphurous, sodium and bicarbonated (Chirica *et al.*, 2018).

Timișești – Iași main water supply pipe AdII conveys water from the Timișești source up to the entrance of Iași Municipality on the Săbăoani, Strunga, Târgu Frumos route. The pipe is made of PREMO tubes with a diameter of 1000 and 800 mm. In Strunga, the pipe crosses Strunga Hill through a hydro-technical gallery. The sulphurous water present outside Strunga hydro-technical gallery led to the degradation of the objective's building materials. The high degree of mineralisation of the aquifer in the Strunga area is confirmed by the existence of a climatic bath resort in this area. The corrosive effect of the embedding environment and groundwater has degraded the concrete and reinforcement elements. The research shows the degradation at the top of the dome, the destruction of the concrete and binder elements (Luca *et al.*, 2008). The concrete walls of the gallery show numerous micro-fissures, fissures and cracks in the horizontal and vertical directions (fig. 3).



**Fig. 3** Structural degradation of Strunga hydro-technical gallery located on AdII Timișești - Iași water supply pipe due to the site's ground pollutant effect; a - reinforced concrete water flow section; b - fissures and micro-fissures in the gallery wall (Luca *et al.*, 2008)

The degradation areas resulted enable infiltration - seepage processes through the Gallery wall, resulting an exchange between the water transported by the Gallery and the one existing in the embedding environment (Luca and Hobjilă, 2005). The contamination of drinking water conveyed through the Gallery takes place on the sections where the pores, micro-fissures and fissures in the structure wall have formed waterways. Water intrusion from the outside through the infiltration process will be enabled when the hydrostatic level of the water in the embedding environment is high. Similarly, if the Gallery does not carry water (situation encountered in case of water supply discontinuity following interventions, scheduled inspections or rehabilitation works) there will be infiltrations from the outside. Water seepage processes from inside the Gallery to the embedding environment are recorded when the water hydrostatic level in the ground is low.



## CONCLUSIONS

1. The drinking water conveyance pipes embedding environment has multiple risk factors that can lead to degradation phenomena of the underground systems, but also to the quality deterioration of the water conveyed by them.

2. One of the most important sources of contamination is the presence of sulphates and chlorides in the site's terrain or groundwater.

3. Iași County territory is characterised by aquifer complexes with high mineralisation levels, which create risk situations in the operational process of the drinking water conveyance pipes.

4. The research carried out at the Strunga hydro-technical gallery on Timișești - Iași supply pipe Ad II highlighted a series of degradations of the concrete structure following its exposure to sulphurous groundwater on site, phenomena exposed by infiltration - seepage processes through the concrete wall.

## REFERENCES

1. **Chirica Ștefania, 2018** -*Raport de cercetare științifică nr. 2. Cercetări privind formarea, evoluția și limitarea pierderilor de apă în rețelele hidroedilitare. Studiu de caz.* Universitatea Tehnică „Gheorghe Asachi” din Iași, Școala Doctorală.
2. **Chirica Ștefania, Luca Al. L., Lateș Iustina, 2018**- *Considerations on drinking water management in the moldavian plateau and plain region*, PESD, Vol. 12, No. 1, pp. 139-147, ISSN 1843-5971 - (Print), ISSN 2284 – 7820 - (Online).
3. **Luca M., Bălan Anca, Toma D., Apetroi I. V., Avram Mihaela, 2015** - *The adduction pipes management on limiting water loss*. Proceedings IWA Regional Conference: Water Loss Management 2015, ARA Publishing, București, Romania, pp. 348 – 356, ISBN 978-606-93752-6-6.
4. **Luca M., Tămășanu F., Luca Al. L., 2008** - *Servicii de inspecție și expertizare - Galerie hidrotehnică Strunga a aducțiunii Timișești – Iași din punct de vedere al siguranței în exploatare și la acțiuni seismice probabile în amplasament*. C70/2008, S.C. Polias-Instal S.R.L., Iași, Beneficiar: R.A.J.A.C. Iași.
5. **Luca M., Hobjilă V., 2005** - *The Hydraulic Analysis of The Strunga Gallery of The Timișești-Iasi Aqueduct*. Ovidius University Annals of Constructions, Volume 1, number 3, 4, 2005, p. 53-61.
6. **Moghareh Abed T., 2014** - *Experimental investigation of cast iron corrosion on clay soil and GPR performance*. Doctoral Thesis, University of Birmingham, UK.
7. **Petersen R.B., Melchers R.E., 2012** - *Long-term corrosion of cast iron cement lined pipes*. Annual Conference of the Australasian Corrosion Association, Proceedings, Melbourne, Victoria, Australia, 11 – 14 noiembrie 2012, pp. 146-157.
8. **Rozière E., Loukili A., El Hachem R., Grondin F., 2009** - *Durability of concrete exposed to leaching and external sulphate attacks*. Cement and Concrete Research, Elsevier, 2009, 39 (12), pp.1188-1198.
9. \*\*\* **STAS 3349/1-83** –Betoane de ciment. Prescripții pentru stabilirea gradului de agresivitate a apei
10. \*\*\* **American Concrete Pipe Association, 2016** -*Precast Concrete Pipe Durability*
11. \*\*\* **Institutul de Geologie și Geofizică, 1978** - Harta Geologică a României, scara 1:1.000.000

## CONSIDERATIONS ON THE VALUATION RAIN - WATERS TO WATERINGS OF THE "GREEN AREAS" OF CITY

### CONSIDERAȚII PRIVIND VALORIFICAREA APELOR PLUVIALE LA UDAREA "ZONEI VERZI" A ORAȘELOR

LUCA AL. L.<sup>1</sup> LUCA M.<sup>2\*</sup>, CHIRICA Ștefania<sup>2</sup>, TOMA D.<sup>2</sup>

\*Corresponding author e-mail: mluca2015@yahoo.com

**Abstract.** *Rain-waters have a problem of exploitation in any sewer system. European rules require the development of sewage systems for urban wastewater in Romania. Storm water must be collected and discharged separately from domestic and industrial wastewater. Some of the rainwater can be harnessed in the collection area by using them to supplement the volumes of water required to extinguish the fire. Rain-waters can be used to wash streets and platforms in localities. But an effective recovery of rainwater takes place in irrigation systems of green spaces. The sewer system consists of collectors, main collectors and storage tanks. The irrigation system of green spaces consists of water tanks, pumping stations and pipeline networks for the transport and distribution of water. The watering methods adopted are aspersion, micro-spraying, dripping and underground watering. The case study confirmed the desirability of using pluvial waste water when watering green spaces.*

**Key words:** park, reservoir, sewerage, watering system, sprinkler

**Rezumat.** *Apele meteorice prezintă o problemă de exploatare în orice sistem de canalizare. Normele europene impun realizarea unor sisteme de canalizare separativă a apelor uzate urbane în România. O parte din apele meteorice pot fi valorificate în zona de colectare prin utilizarea acestora la suplimentarea volumelor de apă necesare la stingerea incendiului. Apele meteorice pot fi valorificate la spălarea străzilor și platformelor din cadrul localităților. Dar, o valorificare eficientă a apelor meteorice are loc în sistemele de irigare a spațiilor verzi. Sistemul de canalizare este format din colectoare, colectoare principale și rezervoare de stocare. Sistemul de irigare al spațiilor verzi este format din rezervoare de apă, stații de pompare și rețele de conducte pentru transportul și distribuția apei. Metodele de udare adoptate sunt aspersiunea, microaspersiunea, udarea prin picurare și udarea subterană. Studiul de caz realizat confirmă oportunitatea utilizării apelor uzate de tip pluvial la udarea spațiilor verzi.*

**Cuvinte cheie:** canalizare separativă, rezervor, sistem de udare, parc

## INTRODUCTION

Among the human rights enshrined in United Nations General Assembly Resolution 64/292 of 28 July 2010 is "access to drinking water and sanitation". The state must contribute to the realization of this right by providing the

<sup>1</sup> Polias-Instal Company Iasi, Romania

<sup>2</sup> Technical University "Gheorghe Asachi" of Iasi, Romania

necessary investment funds for the design and implementation of water supply and sewerage systems. Urban and rural localities must be equipped with centralized, public, sewerage systems at a higher technical level and contributing effectively to environmental protection (ARA 2016).

Compliance with environmental protection requirements requires that sewerage systems be developed in a segregated system. This requirement is particularly appropriate at the present stage, when the precipitations have a severely torrential character on the territory of Romania (Avram and Luca, 2017). Urban sewerage networks in Romania are generally built in a unitary system. Their operation over the last period of time is particularly unsatisfactory, especially in heavy rainfall.

An important source of pollution of the urban environment is the torrential rains and the reduced take-up capacity of the sewerage network. The objective of the paper is to analyze the methods of collecting and capitalizing the meteoric waters within the localities or the locations of economic and social objectives (Bica, 2002).

## **MATERIAL AND METHOD**

Studies and research have been carried out for a series of sewerage networks that carry the meteoric waters. Sewage networks are provided by localities or industrial, economic, administrative and social objectives. The location of the study objectives is affected by the high precipitation intensity, where the effects of the rain cause significant environmental degradation.

The research method has gone through the following steps: a - study of the behavior of the sewer networks within the localities and the impact of the meteoric waters on the mode of operation; b - the study of the behavior of sewerage networks within economic and social objectives at present stage; c - realization of models for collecting and capitalizing the meteoric waters from the location of the different studied objectives; e - directions of applicability of researched models.

## **RESULTS AND DISCUSSIONS**

The objectives of the research were many, among which:

- the current behaviour of the urban sewerage sectors carried out in a unitary system and the role of ensuring optimal environmental conditions;
- the current behaviour of the sewerage networks achieved in unitary system at economic objectives and the influence on the environmental protection parameters;
- designing models for collecting, storing and distributing meteorological waters within localities and economic objectives.

The studies and researches undertaken have highlighted the following:

- on the territory of Romania, and especially in the area of Moldova, there are changes in the monthly and annual distribution of precipitation, high torrential rain with large volumes of water (Avram and Luca, 2017);
- sewerage networks built in a unitary system in cities are malfunctioning in the case of takeover of torrential waters; the sewer collectors discharge into the streets and sites, polluting the urban environment (Tucan and Bica, 2017);

- within the localities, commercial complexes, industrial objectives increased the waterproof surface (concrete and paved areas, building) to the detriment of the green areas; the volume of infiltrated precipitations has declined over the last 20 years to 20% compared to 80% (Luca *et al.*, 2010);

- commercial complexes and industrial objectives have large waterproof surfaces, where torrential rainfall overloads the sewerage system made in unitary system (Scripcariu and Luca, 2014);

- the watering of the green spaces within the localities is made from the public drinking water network; this technology is not indicated due to the chemical parameters of drinking water (the residual chlorine content);

- washing of streets and concrete platforms is done with the water from the public drinking water network; the current process involves high costs and consumption of a volume of water needed by the population.

These conclusions point to a new strategy on meteorological water management within localities, or on smaller areas, specific to industrial or commercial objectives.

The rainfall rate for sewerage basins smaller than 10 km<sup>2</sup> has the expression (Blitz, 1970, STAS 1846-07):

$$(1) \quad Q_{\max} = m S \varphi i \quad [l/s],$$

where  $S$  is the surface of the collection basin for the computation section, (ha);  $i$  - average rainfall intensity (l/s,ha);  $m$  - the flow reduction coefficient;  $\varphi$  - coefficient of leakage.

The flow relationship analysis shows a change in the value of the leakage coefficient,  $\varphi$ , for the localities and the spaces occupied by the big targets. This requirement is imposed by the intense reduction of green spaces within localities or economic objectives. In this case, the leakage coefficient is determined by the relation (STAS 1846-07):

$$(2) \quad \varphi = \frac{\sum \varphi_i S_i}{\sum S_i},$$

where  $S_i$  is a homogeneous surface in the sewer;  $\varphi$  - the coefficient of leakage of  $S_i$  surface. For concrete and asphalt surfaces, the coefficient  $\varphi$  is 0.85-0.90 and for parks 0.01 - 0.05.

At the same time, in order to comply with the European Union requirements regarding the design of sewage systems, separate sewage networks for domestic waste water and for meteoric waters should be developed. Sewage sewerage networks exist in Romania, but many of them have a malfunction in the case of torrential rainfall. All European Union Directive requires the collection and local storage of meteoric waters, and then evacuating them to an emissary.

The meteoric waters collected from the land areas of the localities or the economic objectives can be capitalized in the following areas:

- providing local water reserves for fire fighting;

- achieving water volumes for watering green areas;
- the supply of underground water bodies used by water supply system capture constructions.

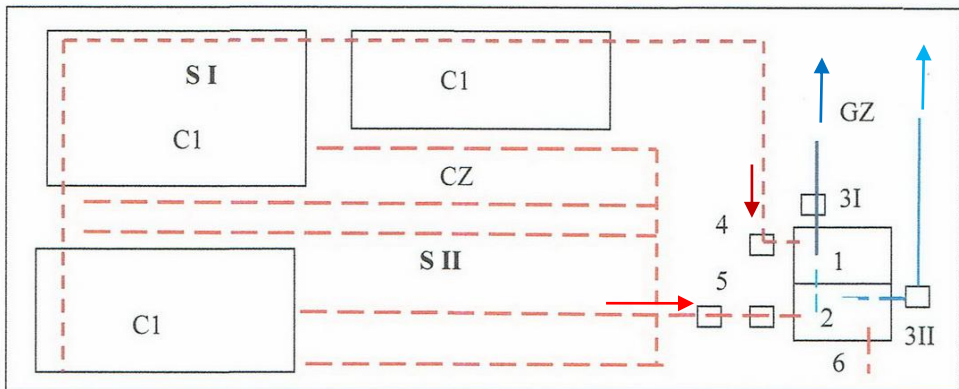
- building volumes of water for sprinkling and washing of streets, alleys, car parks etc.

The use of meteorological waters must meet the conditions laid down in SR 1846/2-07, ie not to be polluted or to contain pathogens.

The model for collecting - storing - distributing meteorological waters for surfaces related to economic and social objectives (factories, commercial complexes, hotels, parking buildings, etc.) can be structured on two water management systems:

- The I system has the function of taking the meteoric waters from the roof of the buildings and their use in fire extinguishing. It consists of the following components: 1 - network of collectors; 2 - two-chamber storage tank (dispenser + storage volume); 3 - pumping station; 4 - distribution system with fire hydrants.

- System II has the function of taking the meteoric waters from the platforms and the traffic areas and their use in watering the green spaces, spraying the platforms and evacuating the surplus to the public sewerage network. System II consists of the following components: 1 - network of collectors; 2 - disinfectant; 3- fat separator; 4 - storage tank; 5 - pumping station; distribution network with greenhouse watering equipment (fig. 1).



**Fig. 1** Scheme of the unitary sewer system at an economic objective with local valorisation of meteoric waters: S I, S II - sewerage systems; CZ - concrete platform; GZ - green area; C1 - terraced roof buildings; 1 - tank for S I; 2 - tank for S II; 3 I, 3 II - pumping station; 4 - desiccant fireplace; 5 - desiccant and grease separator; 6 - discharge to the public sewerage network.

The two systems can present a common tank, but divided into different water volumes (1 and 2, fig. 1). Between the tank chambers, water transfers can be made by using a specialized hydraulic installation.

The model with the two meteorological sewerage systems presented in figure 1 was designed for the location of a factory made in the last period of time in the city of Brasov, Romania. The site area has abundant rainfall (about 700 mm), where their utilization is effective in order to provide volumes of water that can be used for their own purposes. The catchment area has a surface area of about 4.6 hectares and the storage tank has a volume of 350 m<sup>3</sup>.

Buildings have a terrace roof, which favors the collection of rainfall without touching the terrain. Meteorological water is transported by closed collectors to a desiccant house and then stored in the first chamber of the tank (fig. 1). Meteor shower is used as a fire reserve. By means of a pumping station water is discharged into a pipeline network equipped with hydrants mounted on the perimeter of the building. The overflow of the chamber (1) expels in the chamber (2) of the tank, and from there the water is discharged into the sewerage network or into an emissary.

The meteoric water fallen on the concrete platforms of the factory (parking, storage area, walkways, etc.) is collected by drains and led to a desiccator, a grease separator and then inserted into the chamber 2 of the tank. The water in room 2 is used to water the green area of the factory and to wash the concrete surfaces. The surplus of water is discharged to the public network.

The irrigation system of the green spaces consists of the components: pumping station for raising the pressure, supply and distribution pipe network, water connections with 12 ... 25 mm connection, fixed and mobile watering equipments (fig. 2). Greening of green spaces is achieved by sprinkling (fig. 2), drip and underground. For sprinkler watering, microsprays, sprinklers and fixed nozzles are used. For pavement layers or large line sizes, drip and underground watering equipment is used.



**Fig. 2** Greenhouse irrigation equipment: a - microsurspers placed on perimeter and wetted surface; b - extendable hose displacement sprinkler

Within the sewerage system connected to a sewerage basin of meteoric waters in a locality, a technical and economical analysis can be carried out regarding the collection, storage and capitalization of the waters in order to water

the green spaces. Quality parameters of meteoric water in the sewer are those that dictate how it is used. The storage of meteoric water can be done in specially designed underground retention basins / reservoirs in natural lakes and artificial lakes. Retention basins ensure the take-off peak flow generated when the rainfall duration is equal to or greater than the concentration time (NP 133-2013).

The presence of some pollutants requires pre-treatment of meteoric wastewater. At the same time, the collection of polluted meteoric waters allows the protection of green areas by eliminating the possibility of degradation of the emissary or the land. The retention basins allow the discharge of some volumes of water into the sewers of the domestic wastewater network in order to obtain a flow to ensure the optimal transport speed.

## CONCLUSION

1. Compliance with European standards requires the development of sewerage systems and the local capitalization of meteoric waters contributes to the protection of the environment in urban and rural localities.

2. The collection and local storage of meteoric waters allows them to be used for wetting green areas in the area of localities and limiting the destructive effects on the environment through wastewater discharge.

3. The use of meteoric waters in the area of localities requires the creation of a specialized infrastructure consisting of sewer collectors, storage tanks, pumping stations and distribution networks with greening equipment.

## REFERENCES

1. **Avram Mihaela, Luca M., 2017** - Analysis of phenomena with hydrologic large risk in the hydrographic basin of the Trotuș River., 3-5 jun., PESD Vol. 11, no. 2, 2017, "Al. I. Cuza University of Iasi", pp. 77-87 ISSN: 1843-5971, ISSN: 2284-7820.
2. **Bica, I., 2002** - *Protecția mediului. Politici și instrumente*, Editura H\*G\*A\*, București.
3. **Blitz E., 1970** - *Proiectarea canalizărilor*, Editura Tehnică, București.
4. **Luca M., Tămășanu F., Luca Al. L., 2010** - *Reabilitarea și re tehnologizarea rețelei de canalizare stradală*. A 45-a Conferința Națională de Instalații „Instalații pentru mileniul trei”, vol. II, Sinaia, p. 305-311.
5. **Scripcariu C., Luca M., 2014**, *Considerații privind reabilitarea colectoarelor de canalizare nevizitabile*, A.I.I.R, Universitatea Tehnică „Gheorghe Asachi” Iași, Edit. Societatea Academică „Matei-Teiu Botez” p. 87-95, ISSN 2069-1211.
6. **Tucan Laura Elena, Bica I., 2017** - *Flood prevention measures in cities undergoing urban expansion*. RomAqua, nr. 3, an XXIII, vol. 117, București, Romania, pp. 24-29.
7. \*\*\* **Asociația Română a Apei (ARA), 2016** - *Raport stadiul tehnologic 2016 sisteme de alimentare cu apă și canalizare*, București, iunie 2016.
8. \*\*\* **NP 133-2013** *Normativ privind proiectarea, execuția și exploatarea sistemelor de alimentare cu apă și canalizare a localităților. Vol. 2 Canalizări*. Ministerul Dezvoltării Regionale și Administrației Publice, Edit. Matrix Rom, București, 2013.
9. \*\*\* **SR 1846/2-2007** *Canalizări exterioare. Prescripții de proiectare. Partea 2. Determinarea debitelor de ape meteorice*.

## STUDIES AND RESEARCH ON POLLUTION OF THE INDUSTRY ENERGY ON THE GREEN AREA OF THE CITY

### STUDII ȘI CERCETĂRI PRIVIND POLUAREA INDUSTRIEI ENERGETICE ASUPRA ZONEI VERZI A LOCALITĂȚILOR

LUCA M.<sup>1\*</sup>, LUCA AL. L.<sup>2</sup>

\*Corresponding author e-mail: mluca2015@yahoo.com

**Abstract.** *The urban environment is heavily influenced by the pollution generated by thermo-power plants. Their work program and the fuels used generate intense pollution of urban green spaces. In the case of thermoelectric power plants on gaseous and liquid fuels (methane + fuel), the emissions of the gases (CO, NO, NO<sub>2</sub>, SO<sub>2</sub>), which by hydration produce acids, occur in the atmosphere. Acid rains work on green areas continuously over the dominant wind direction. The case study conducted in the Iasi area indicated the pollution area, the concentrations of the pollutants and the lengths of the noxious transport in the considered area. The study of the dispersion of noxes in the atmosphere is done by modeling the functional phenomena of the polluting sources.*

**Key words:** chemical pollutants, dispersion, dispersion model, impact

**Rezumat.** *Mediul urban este puternic influențat de poluarea realizată de centralele termo-energetice. Prin programul de lucru al acestora și combustibili folosiți produc o poluare intensivă a spațiilor verzi urbane. În cazul centralelor termo-energetice pe combustibili gazoși și lichizi (gaz metan + păcură) se produce emisia în atmosferă a gazelor (CO, NO, NO<sub>2</sub>, SO<sub>2</sub>), care prin hidratare produc acizi. Ploile acide acționează asupra zonelor verzi în mod continuu pe direcția vântului dominant. Studiul de caz întocmit în zona orașului Iași a indicat arealul de poluare, concentrațiile substanțelor poluante și lungimile de transport a noxelor în zona considerată. Studiul dispersiei noxelor în atmosferă se realizează prin modelarea fenomenelor funcționale ale surselor poluante.*

**Cuvinte cheie:** poluanți chimici, dispersie, model de disperse, impact

## INTRODUCTION

The city is made up of a complex of natural and artificial factors, which determine a number of facilities for the normal development of life. But some of the factors are harmful to human activity, depending on how they are organized and used by the community. At this stage, harmful artificial factors are multiplying more and more.

Pollution of the natural environment (soil, water, air) and human is made in a close dependency. An environmental pollution process has to be studied from the air circuit and continued with the water and soil circuit, then completed with the anthropic circuit (Hameed and Dignon, 1992; Luca, 1993). Most overground

<sup>1</sup>Technical University "Gheorghe Asachi" of Iasi, Romania

<sup>2</sup>Polias-Instal Company Iasi, Romania



pollution sources distribute noxes (dusts, gases, vapours, aerosols, etc.) in the lower layer of the troposphere, at a height of about 0.5 to 2.0 km. The study of pollutant dispersion phenomena in the air must be carried out in this layer.

The study models used to analyze the phenomena of dispersion of pollutants are mathematical, physical and mixed. Physical models cover a field of research that is difficult to address by mathematical models, such as dispersion of pollutants in varied relief areas (including large cities) (Kenjeres *et al.*, 2006).

An important source of pollution of the atmosphere, soil, water and the human environment is represented by the energy industry that operates with solid and gaseous fuels. The objective of the paper is to analyze the phenomenon of dispersion of pollutants in the atmosphere and the impact on the urban and the external environment by the thermoelectric power plants (Hameed and Dignon, 1992).

## MATERIAL AND METHOD

Studies and research have been carried out for a number of objectives in the power industry, such as the Thermoelectric Power Plants - CET. In the area of Moldova was analyzed CET Iasi, which is a producer of electricity, steam and hot water for the city of Iasi.

The wind direction in the study area has a NA - SE orientation as an annual average value and holds about 24% of the total annual. The wind in NE-SV direction accounts for 15% of the annual total. The predominant wind during the winter period is in the N-E direction. Average monthly hourly average speeds are recorded in March (3.60 m/s). Maximum daily average speeds are recorded in the NV - SE direction and reach values of 5.70 - 7.50 m/s. The maximum speeds recorded in the area reached 13 m/s and in gusts of 55 m/s (Luca, 2005).

The research method has gone through the following steps: a - studying the relief and climate characteristics of the pollutant source area and the pollutant dispersion area; b - analyzing the technical parameters of the pollutant; d - realization of the model of analysis of the pollution phenomenon; e - modeling the phenomenon of dispersion of pollutants into the atmosphere; f - data processing and interpretation, forecast of the pollution phenomenon.

## RESULTS AND DISCUSSIONS

The research was carried out by a team of researchers from the Technical University "Gh. Asachi" Iasi in collaboration with specialists from research and design institutes. Research has been carried out over a long period of time, and the results have been harnessed when designing polluting targets. The objectives of the research were many, among which:

- the correct position of the polluting objects in the inhabited areas in order to limit their polluting effect;
- forecast of the pollution phenomenon on inhabited areas, urban green areas and extra-urban areas, by determining the polluted surfaces and the concentrations of pollutants at different source distances, etc.

The forecast of the greenhouse pollution phenomenon is imposed by the high degree of urban pollution in Romania in the current period, correlated with a decrease in the area occupied by parks and gardens. The research aims at determining the size of the polluted surfaces, the concentrations of pollutants at different distances from the pollutant source and the type of noxes transmitted in the territory.

The research is done by physical and / or numerical modelling of the phenomenon of pollution. Numerical modelling of the pollution phenomenon is done for ideal relief conditions (quasi-plan land) and with some restrictions on simulating the atmospheric boundary layer (Kenjeres *et al.*, 2006). Physical modelling is applicable to any type of relief (plain, hill and mountain), way of planning localities and various atmospheric conditions (Luca, 1993).

Physical modelling involves two working methods for the same pollutant objective: aerodynamic modelling and hydraulic modelling. Aerodynamic modelling was done in a specialized (Shiau and Chiou, 2006). Hydraulic modelling was carried out in a hydraulic channel with dimensions corresponding to the modelling ladders. In the aerodynamic tunnel / hydraulic channel were mounted models simulating the land surface with the location of the pollutant source and the research area considered.

The two phenomena present a perfect identity of the equations describing the physical process (Luca, 2005):

- equation of continuity ec. (1) and ec energy. (2),

$$(1), \quad \frac{\partial V_i}{\partial x_i} = 0, \quad (2) \quad \frac{\partial \Delta\theta}{\partial t} + \frac{\partial \Delta\theta}{\partial x_i} V_i = a \frac{\partial^2 \Delta\theta}{\partial x_i \partial x_j},$$

- preservation of the impulse ec (3),

$$(3) \quad \frac{\partial V_i}{\partial t} + V_j \frac{\partial V_i}{\partial x_j} + 2\varepsilon_{i,j,k} V_k \Omega_j = -\frac{1}{\rho_0} \frac{\partial \Delta P}{\partial x_i} + \frac{g}{\theta_0} \Delta\theta \delta_{3i} + \frac{\nu \partial^2 V_i}{\partial x_k \partial x_k};$$

- the molecular diffusion of the gas emitted by the ec source (4),

$$(4) \quad \frac{\partial c}{\partial t} + v_i \frac{\partial c}{\partial x_i} = \alpha \frac{\partial^2 c}{\partial x_i \partial x_i},$$

where  $t$  is the time;  $\theta$  - the temperature;  $V$  - instantaneous speed;  $\Delta P$  - pressure difference compared to neutral atmosphere;  $\Delta\theta$  - temperature difference;  $\Omega$  - the angular rotation speed of the Earth;  $\nu$  - kinematic viscosity;  $a$  - thermal diffusivity;  $\rho_0$  - density;  $c$  - instantaneous concentration;  $\alpha$  - molecular diffusion coefficient;  $\varepsilon_{i,j,k}$  - the alternating tensor;  $\delta_{ij}$  - the size of Kronecker;  $t$  - time.

In the case of the pollutant sources of the thermoelectric power plants (CET Iași), the dispersal area and the concentration of the noxes in bound points were determined (fig.1). The boiler is equipped with three flue gases (methane + fuel) and four cooling towers (tab. 1). The pollutant source is surrounded by industrial and housing districts (60% constructions, 20% platforms, 20% roads + green spaces) in the direction of the dominant wind (fig. 2). The height of the buildings in the study area is 10 ... 40 m.

The wind direction in the study area has a NA - SE orientation as an annual average and accounts for about 24% of the annual total. The wind in NE-SV direction accounts for 15% of the annual total. The predominant wind in winter is in the N-E direction. Average monthly hourly average speeds are recorded in March (3.60 m/s). Maximum daily average speeds are recorded in the NV - SE direction and reach values of 5.70 ... 7.50 m/s. The maximum speeds recorded in the area are 13.0 m/s and in gusts of 55.0 m/s. Frequently, the speed is 20.0 m/s. Previously, the wind speed at the top of each chimney ( $H_1 = 100$  m) was determined (Luca, 1998).

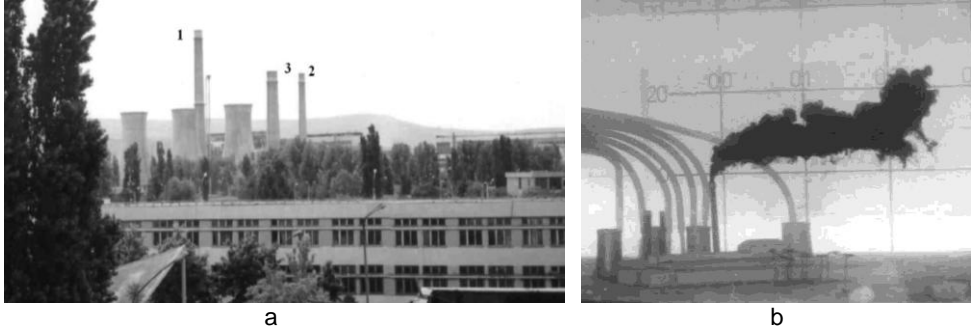


Fig. 1 Thermoelectric power plant studied: general view (1, 2, 3 chimney); b - hydraulic simulation model.

Table 1

Smoke chimney parameters

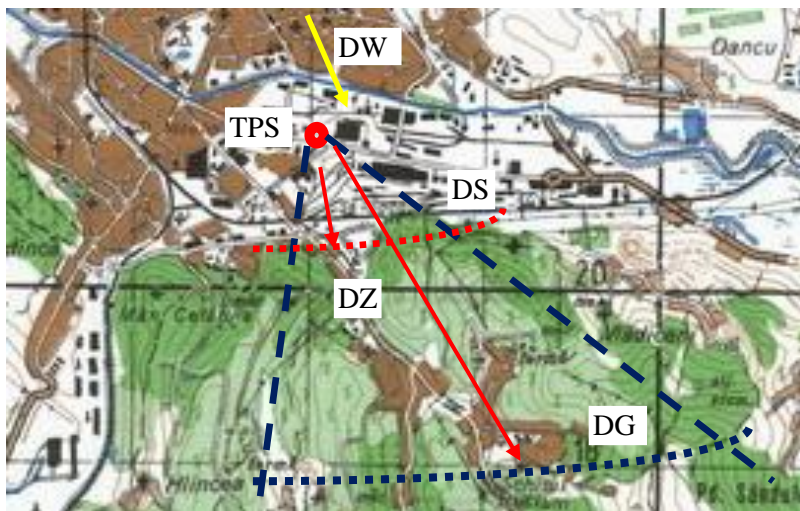
Chimney	$H$ (m)	$D$ (m)	$Q_g$ ( $m^3/h$ )	$T$ ( $^{\circ}C$ )	$v_g$ (m/s)
Chimney 1	100	5.00	1,500,000	120-200	21.2
Chimney 2	70	3.50	734,000	120-200	21.2
Chimney 3	70	6.90	450,000	90-200	3.30

$H$ -height;  $D$  - inner diameter at the top;  $Q_g$  - flue gas flow;  $T$  - gas temperature;  $v_g$ -velocity of the ejected gas

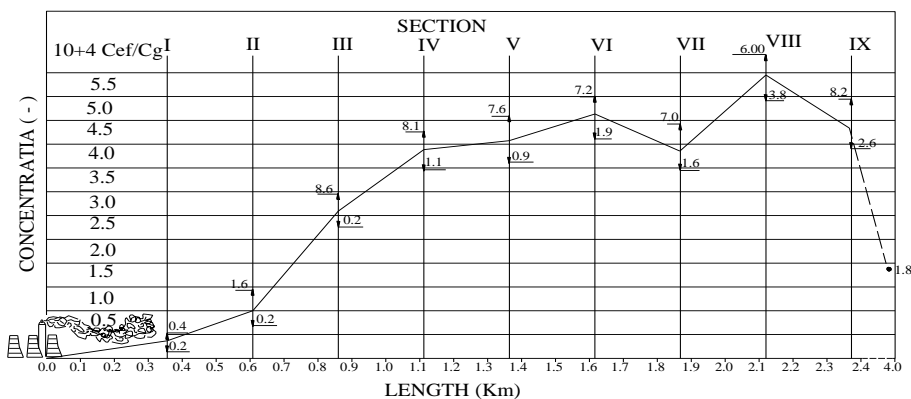
In the direction of the dominant wind a 7,000 m long and 650 m wide terrain was shaped (fig. 2). The length at which NO is determined is 3.5 km. On the simulation model, the velocity profile in the atmospheric limit layer for various meteorological conditions was achieved (Luca, 1993). By simulation the contact distance  $L_c$  of the smoke plume with the ground for each chimney was determined and the values of the concentration of the pollutant in the dispersion zone. The length of contact with the terrain of the feather varies between 350 ... 900 m for the basket of 100 m high and 200 ... 700 m for the 70 m high chimneys. In model and reality, smoke moves under gusts and wind whirlwinds, so the point of contact with the land is not stable but variable.

The values of the concentration of pollutant in the dispersion area were determined for each basket operating individually and for all three in operation. Figure 3 presents the results of the Basket 1 research (Relative Concentrations,  $C_{ef} / C_g$ ) in the  $v_v/v_g = 4.5$  ratio, where the model corresponded to  $v_g = 56.7$  cm/s and  $v_v = 12.8$  cm/s.

The pollutants emitted in the air by a chimney are gaseous, liquid and solid. Their deposition starts near the chimney (solid particles) and extends over large and very large distances (2.0-2000 km) depending on the specific gravity of each and the value of the transport vector (wind).



**Fig. 2** Forecast of the pollutant dispersion area in the dominant wind direction: TPS - thermoelectric power station, DW - the dominant direction of the wind; DZ - dispersion area; DS - solid particle dispersion area; DG - gas dispersion area



**Fig. 3** The variation in the concentration of noxes emitted by the chimney 1 in the dispersion zone

The main gaseous substances in a thermoelectric plant operating on methane gas with the addition of fuel oil are: monoxide and carbon dioxide ( $\text{CO}$ ,  $\text{CO}_2$ ), monoxide and nitrogen dioxide ( $\text{NO}$ ,  $\text{NO}_2$ ) and sulfur dioxide and trioxide ( $\text{SO}_2$ ,  $\text{SO}_3$ ). They are transported over long distances depending on the height of the chimney, the ascent of the smoke in the atmosphere, the type of relief, the value of

the gradient wind velocity, etc. During transport, the monoxides and dioxides are hydrated into the atmosphere and converted into acids. For example, nitrogen dioxide ( $\text{NO}_2$ ) by hydration is converted to nitric acid and then to nitric acid over the transport length. The transition from the gaseous phase to the liquid determines the quicker deposition of pollutants and their action on the environment.

Relief influences the evolution of the fume gas emitted by the chimney. An uneven relief will cause the occurrence of whirlwinds that will come close to ground smoke and will facilitate the deposition of pollutants. In the case study, an intersection of the smoke fume issued by CET Iasi with the Caprița and Balan hills in the Bucium area resulted. As can be seen from figures 2 and 3, the smoke emitted by the chimney 1 will reach the ground after about 3.5-4.0 km.

Pollutant emissions from the thermoelectric power plant affect urban green areas located south of it (the Bularga and Socola charters), but also the Bucium hills, depending on the ground level. The relative value of the soil pollutant concentration varies from the  $C_{ef}/C_g$  deposition area = 1.0 to 600 m, up to  $C_{ef}/C_g = 6.0$  at 2100 m, and at a distance of 4100 m to  $C_{ef}/C_g = 1.80$ .

## CONCLUSIONS

1. Pollution from thermal power plants has a particularly negative impact on urban areas through the complex content of solid, liquid and gaseous substances of aggressive nature over green areas.

2. For a field with a varied relief, the experimental investigation of the pollution phenomenon in order to obtain the location of the polluting objects, of the affected areas and the prognosis in the territory of the pollutant concentrations is indicated.

3. Green areas are affected by pollutants with a chemical acid character, a situation specific to the thermoelectric power plants with oxides and nitrogen and sulfur dioxide emissions on burning of methane gas and fuel oil.

## REFERENCES

1. Hameed S., Dignon J., 1992 - *Global emissions of nitrogen and sulphur oxides in fossil fuel combustion 1970-1986*. J. Air Waste Management Association, 42.
2. Kenjeres S., Hagenzieker R., Hanjalic K., 2006 – *Numerical simulation of turbulent flows over hills and complex urban areas with dispersion of pollutants*. Proceedings Conference “Modeling fluid flow”, Budapest University of Technology and Economics, Hungary, vol. I, pp.125-132.
3. Luca M., 2005 - *Researches regarding the pollutants dispersion of the thermoelectric power station*. Buletinul Institutului Politehnic din Iași, tom LI (LV), fasc. 1-4 (I), Hidrotehnică, p. 91- 102.
4. Luca M., 1998 - *Hydraulic Modeling of the Limit Atmospherically Stratum*. Procces. Int. Conf. of the Engineering Wind, Bucuresti, Romania, p. 55-62.
5. Luca M., 1993 - *Simulation of the Limit Atmospheric Stratum*. Bulet. Iași Techn. University, tom XXXIX (XLIII), fasc. 1-4, secția VII, p.79-84.
6. Shiau B.S., Chiou H.S., 2006 – *Wind tunnel study of fence shelter on continuous release of heavy gas in the turbulent boundary layer flow*. Proceedings Conference “Modeling fluid flow”, Budapest University of technology and economics, Hungary, vol. I, pp.140-147.

---

## STUDIES AND RESEARCH ON ENVIRONMENTAL POLLUTION TO INDUSTRIAL WASTE DEPOSITS

### STUDII ȘI CERCETĂRI PRIVIND POLUAREA MEDIULUI DE CĂTRE DEPOZITELE DE DEȘEURI INDUSTRIALE

LUCA M.<sup>1\*</sup>, LUCA AL. L.<sup>2</sup>, MARCOIE N.<sup>1</sup>, AVRAM Mihaela<sup>3</sup>

\*Corresponding author e-mail: mluca2015@yahoo.com

**Abstract.** *The Moldovan area has a large number of industrial waste deposits containing mine waste, slag, ash, technological waste etc. The presence of the deposit causes the air, soil, subsoil, surface and underground waters, flora and fauna and the mental state of the people to be polluted. The case study made at a landfill site highlights the multiple forms of induced pollution and their serious consequences on the environment. The deposit consists of a mixture of slag, foundry residues, industrial liquids, etc., which are extremely aggressive in air, soil, surface and underground waters. Physical and chemical indicators analyzed for soil in the area adjacent to the landfill were pH, Cd (cadmium), Mn (manganese), P (lead), SO<sub>4</sub> (sulphate), etc. The pollution phenomenon affects all forms of environment in a serious form and the impact is indefinite.*

**Key words:** air, ash, impact, soil, slag, underground

**Rezumat.** *Zona Moldovei prezintă un număr mare de depozite de deșeuri industriale ce conțin steril de mină, zgură, cenușă, reziduuri tehnologice etc. Prezența depozitului determină poluarea aerului, solului, subsolului, apelor de suprafață și subterane, a florei și faunei, dar și a stării psihice a oamenilor. Studiul de caz întocmit la un depozit de deșeuri siderurgice evidențiază multiplele forme de poluare induse și consecințele grave ale acestora asupra mediului. Depozitul este format dintr-un amestec de zgură, reziduuri de turnătorie, lichide industriale etc., care au un caracter extrem de agresiv asupra aerului, solului, apelor de suprafață și subterane. Indicatori fizico-chimici analizați pentru solului din zona învecinată depozitului de deșeuri au fost pH-ul, Cd (cadmiu), Mn (mangan), P (plumb), SO<sub>4</sub> (sulfați) etc. Fenomenul de poluare afectează într-o formă gravă toate formele de mediu, iar impactul este pe o durată nedeterminată.*

**Cuvinte cheie:** aer, cenușă, impact, mediu subteran, sol, zgură

## INTRODUCTION

The environment is the whole of the Earth's natural components and the conditions of their existence. Components are defined by air, water, soil and subsoil, flora and fauna, time-based social values, interactions between these components, etc. Pollution is a process of alteration of biotic and abiotic living

---

<sup>1</sup>Technical University "Gheorghe Asachi" of Iasi, Romania

<sup>2</sup>Polias-Instal Company Iasi, Romania

<sup>3</sup>A.B.A – Siret Bacau, Romania

environments, but also of the values created by human society. Pollution can be a degradation of the environment caused by natural factors and anthropogenic factors.

One of the 13 areas of regulation through the "acqui" in the field of the environment is represented by the vast and complex field of "waste management", which contains specific regulations on industrial waste deposits (Luca *et al.*, 2012).

In Romania, about 950 such constructions are considered as industrial landfills. Among these, according to their nature, the following classification is allowed: industrial waste landfills, about 354; mining tailings dumps, about 251; tailings ponds / basins, about 209 and other types. All these industrial landfills involve special problems of environmental pollution (Bălan, 2010; Luca *et al.*, 2012).

## MATERIAL AND METHOD

Studies and research have been carried out for a number of industrial waste dumps located in Moldova. Each warehouse has specific design, construction, exploitation and environment pollution. The paper (Bălan, 2010) presents a synthesis of the pollution induced by these deposits. A special situation is represented by the landfill, especially slag, belonging to S.C. ARCELOR MITTAL S.A. Galati (former Galati Steel Works).

The construction of the slag deposit started in 1968. The waste was stored in the warehouse resulting from the technological process of the Galati Steel Works (fig.1). The analyzed slag pit is located in the western part of the steel mill and borders with the Balta Mălinei to the north, west and south, and to the east, the road of exploitation of the commune of Șendreni commune. The site of the dump starts at 10.00 m on a plateau between the Cătușa and Mălina valleys and the agricultural lands of Smârdan and Movileni. The hydrography of the area is dominated by the tributaries of the Mirena River and the tributary of the Siret left tributary. Industrial wastewater treatment is carried out in tailings ponds located at the edge of the slag pit (fig. 2).



**Fig. 1** Waste landfill in operation

The landfill occupies an area of approx. 110 ha. The average storage height is approx. 50 m and it varies over the entire surface depending on the exploitation rate of the deposit. Located in the west of the steel mill, the heap began by occupying the eastern bank of Lake Malina, advancing to the other water-covered areas. The

advancement occurred horizontally but also with a continuous slope, so starting from 40-46 m level, the discharge fronts area reached approx. 60 m.



**Fig. 2** Ponds for liquid and industrial wastewater decantation: a - general view of the pond with the settling basins; b - detail of the pond partition.

Primary data was processed using the statistical calculation programs and hydrological, hydraulic and pollutant computing programs applicable to the case study (Charbeneau, 2000; Appelo and Postma, 1996).

## RESULTS AND DISCUSSIONS

The raw material used in the iron and steel industry is iron ore and coke. As a result of technological processes, there are large quantities of residues with different degrees of pollution. But they are large in volume and impose problems with their processing and storage. Much of the waste in the steel industry falls into the category of hazardous waste. The main types of waste are: blast furnace slag, steel slag, ash, sludges etc. The polluting substances present varying concentrations and the representative ones are dissolved salts (chlorides), heavy metals (arsenic (As), copper (Cu), lead (Pb), zinc (Zn), cadmium (Cd), chromium (Cr), manganese (Mn), iron (Fe), etc.).

During the period 1968 - 2008, they were transported on the site of the slag dump approx. 36 million tons of blast furnace slag and approx. 14 million tons of steel slag. These have been distributed over the heap surface in a more or less selective manner. Between 2003 and 2006, 3,0 million tons of blast furnace slag, 1,50 million tons of steel slag and 600,000 tonnes of other waste were deposited in the warehouse. An estimated weight of the materials stored in the warehouse is as follows: furnace slag - approx. 47%; steel slag - approx. 30%; Refractory wastes and others - approx. 23 %. The volumetric density of the deposited material is  $2100 \text{ kg/m}^3$ .

Part of the waste is recovered periodically, in order to recover the useful substances and use them for other purposes. In many cases, these wastes were stored in unsuitable conditions without land preparation, wind and rain



transporting these wastes in large areas and infecting in many cases both groundwater and surface water, thus seriously affecting the environment.

Currently it has a selective management of slag waste. Separate areas have been set up for waste disposal. In the near future, the maximum waste recovery will be achieved by the excavation and processing of the dross in the dump without, however, affecting the stability and safety of the deposit. Waste that can not be recycled will be stored in distinct, controlled and selective areas according to technology.

To assess the environmental impact of landfill pollution, tables 1 and 2 present analyzes results of the performed on soil samples taken from the eastern side of the plant site over a longer period of time.

Table 1

**Analysis of chemical indicators determined in control section of the dump area (inside the plant) (Bălan, 2010)**

Ground proof code	Parameters				
	pH	Cd	Mn	Pb	SO <sub>4</sub> <sup>-</sup>
U. M		mg/kg	mg/kg	mg/kg	mg/kg
E / area	8.18	1.42	1370	53.2	460.2
E / 30 cm	8.20	1.58	1399	46.7	880.2
Normal values <sup>1</sup>		1	900	20	-
Alert threshold <sup>1</sup>		5	2000	250	5000
Intervention threshold <sup>1</sup>		10	4000	1000	50000
<sup>1</sup> Ord. 756/1997					

The analysis of the data presented in table 1 shows exceedances of normal values for cadmium, manganese, lead and pH values for soil samples collected in the plant. The other values fall within the permitted limits imposed by the standards.

Table 2

**Analysis of chemical indicators determined in control section of the dump area (outside the enclosure) (Bălan, 2010)**

Ground proof code	Parameters				
	pH	Cd	Mn	Pb	SO <sub>4</sub> <sup>-</sup>
U. M		mg/kg	mg/kg	mg/kg	mg/kg
E / area	8.26	1.61	1270	38.2	601.4
E / 30 cm	8.22	1.83	1184	37.5	909.8
Normal values <sup>1</sup>		1	900	20	-
Alert threshold <sup>1</sup>		3	1500	50	2000
Intervention threshold <sup>1</sup>		5	2500	100	10000
<sup>1</sup> Ord. 756/1997					

Data analysis shows that soil samples have a pH value above 8.0, which gives the soil an alkaline character in the area. The concentration of lead in all

analyzed samples is above the normal values, without exceeding the intervention threshold or for sensitive uses.

Given the location of the sampling points towards the slag heap and the prevailing wind direction, the negative effect of its activity on the soil environmental factor can be highlighted.

The analysis of the data presented in table 2 shows for the outer area of the steel plant compartment overshoot of the normal values of the metal content (same as in the combustion chamber). The pH value for soil samples collected outside the enclosure is significantly higher and shows a high degree of alkalinity. The other values fall within the permissible limits.

The analysis carried out within the deposit during the research revealed the following risk situations (Bălan, 2010):

- the natural or artificial waterproofing of the deposit is not carried out;
- the landfill does not have a drainage system for collecting and treating the leachate;
- there are no guard channels for collecting the meteoric waters;
- the landfill does not have a collection and exhaust system for the storage gas;
- meteoric waters infiltrated into the landfill are not collected and discharged through a suitable drainage system;
- groundwater is contaminated by uncontrolled infiltration from the landfill.

The meteoric waters that infiltrate the deposited material infiltrate into the soil from where it reaches the groundwater and then into the emissary (Mălina pond). Also, the water leaked on the slope of the deposit produces an erosion phenomenon after which it is evacuated in the Mălina pond. Part of this water is absorbed by the mass of the deposit or the soil in the adjacent area. Infiltrated water influences the quality of the underground water and the water in the Mălina pond.

On the southern part of the heap there is the Mălina South tailings pond, through which the wastewater taken over by the C8 collector from the transshipment of the steel and furnace slag is discharged into the Mălina pond.

Since there is no drainage and collecting system for the leachate generated by the percolation of the deposit by the meteoric waters, the slag through its site influences both the quality of the underground water and the emissary (the Mălina pond). The waters of Mălina pond are discharged into the Siret River with an important contribution of industrial pollutants (Mănescu, 2013).

By overcoming the area of storage and distribution of industrial waste in the western part of the waste dumps, there were recorded some slopes in the slope of the deposit in 2004 and 2005. This phenomenon has caused clogging processes and even obstructions of the water outlet channel in the Mălina North area.

Proper monitoring of the operation of the landfill requires strict monitoring of the liquid, gaseous and solid emissions. It aims at verifying the compliance of emissions with the conditions imposed by the rules in force (environmental permit, water management permit).

The groundwater monitoring process should be performed for parameters: pH, suspensions, fixed residue, CCOCr, chlorides, sulphates, nitrates, ammonium, Fe, Ca, Mg, phenols, cyanides, Cr, Zn, Mn, Pb, Ni. The samples shall be taken from the observation drills executed on the site and adjacent to it. The samples are analyzed and the results are compared with the values imposed by the standards and norms in force (Stematiu, 2002). For groundwater monitoring, two drillings executed up to a depth of 21.0 m are used (Bălan, 2010).

## CONCLUSIONS

1. The safe disposal of industrial landfills must be carried out in accordance with the regulations in the field correlated with those laid down in European legislation.

2. Slag deposits from steel plants require special attention due to the components included. They sensitively influence the stability and circulation of surface and underground water.

3. Safeguarding of the landfill must be carried out during the exploitation phase by adopting measures to control the extension and elevation of the landfill, but without affecting and polluting the site environment. Research in the case study indicates various stages of groundwater and surface water pollution.

4. In the exploitation and conservation phases, a permanent monitoring of the site-specific parameters as well as of the site environment must be carried out to minimize environmental pollution.

## REFERENCES

1. Appelo C.A.J., Postma D., 1996 - *Geochemistry, groundwater and pollution*. Balkema Publ. House.
2. Bălan P. R., 2010 - *Contribuții la creșterea siguranței în exploatare a haldelor de steril în privința reducerii potențialului de poluare*. Teză de doctorat, Universitatea Tehnică „Gheorghe Asachi” din Iași, p. 267.
3. Charbeneau, R., J., 2000 - *Groundwater Hydraulics and Pollution Transport*. Prentice Hall, New Jersey, SUA, 2000.
4. Luca M., Balan R.P., Mănescu A., Luca Al., L., 2012 - *Modelling pollution transport of the industrial waste underground*. Conference on Modelling Fluid Flow (CMFF'12). The 15<sup>th</sup> Event of International Conference Series on Fluid Flow Technologies, Budapest, Hungary, p. 523...530.
5. Mănescu Andreea, 2013 - *Contribuții la monitorizarea și modelarea fenomenului de poluare a cursurilor de apă*. Teză de doctorat, Universitatea Tehnică „Gheorghe Asachi” din Iași.
6. Stematiu D., 2002 - *Iazuri de decantare – Managementul riscului*. Editura MATRIX ROM, București.

**PRELIMINARY RESULTS REGARDING THE  
DETERMINATION  
OF THE WATER SUPPLY OF EGGPLANTS**

**REZULATE PRELIMINARE PRIVIND DETERMINAREA  
CONȚINUTULUI DE APĂ ÎN PLANTELE PĂTLĂGELE VINETE**

**ACHIȚEI V.<sup>1</sup>, GHEORGHITOAIIE M.<sup>1</sup>, TELIBAN G.C.<sup>1</sup>,  
COJOCARU A.<sup>1</sup>, STOLERU V.<sup>1\*</sup>**

\*corresponding author: vstoleru@uaiasi.ro

**Abstract.** *The present paper places plants as a coordinating element in the irrigation ensemble, where they can provide data on moisture and can achieve numerically the limits to which their biological systems operate optimally. The genesis of this system is based on the intensity of the electrical current measured between the two electrodes, intensity which is in relation to indirect proportionality with the hydric deficit measured at the sap level. The plant's water supply was measured using two electrodes, represented by medicinal needles specifically treated to prevent oxidation during use. In order to highlight the currents of low intensity, a galvanometer was used. On the basis of this method were performed measurements demonstrating the decrease of the intensity of electrical conductivity inversely proportionate to the water content, the average in the group subjected to stress hydric (L2) on day 3 with the value of 6.22 Amp, gradually decreasing the As the period during which it was subjected to a hydric deficit increased, reaching 3.92 Amp on day 4, 2.54 Amp on day 5 and 1.67 Amp on Day 6, compared to the normal average of 6.35 Amp. On the last day, the stage in which the group subjected to a lack of water (L2) was hydrated, a return was found in terms of the intensity values at the average of 3.44 Amp, which strengthens the relationship between the variation of the two characteristics.*

**Key words:** *Solanum melongena*, water, irrigation

**Rezumat.** *Lucrarea de față poziționează plantele ca element de coordonare în ansamblul de irigare, unde acestea pot furniza date cu privire la umiditate și pot concretiza la nivel numeric limitele la care sistemele biologice ale acestora funcționează optim. Geneza acestui sistem are la bază intensitatea curentului electric măsurat între cei doi electrozi, intensitate care este în relație de indirectă proporționalitate cu deficitul hidric măsurat la nivelul sevei. Gradul de aprovizionare cu apă al plantei a fost măsurat folosind doi electrozi, reprezentativi de ace medicinale tratate special pentru a preveni oxidarea pe durata folosirii. Pentru punerea în evidență a curenților de intensitate scăzută, a fost utilizat un galvanometru. Pe baza acestei metode s-au realizat măsurători ce au demonstrat scăderea intensității conductivității electrice proporțional cu conținutul de apă, media în lotul supus stresului hidric (L2) în ziua a 3-a având valoarea de 6.22 Amp, scăzând progresiv pe măsură ce perioada în care a fost*

---

<sup>1</sup>University of Agricultural Sciences and Veterinary Medicine of Iasi, Romania

*supusă unui deficit hidric creștea, ajungând la 3,92 Amp în ziua a 4-a, 2,54 Amp în ziua a 5-a și 1,67 amp în ziua a 6-a, față de de media normală de 6,35 amp. În ultima zi, etapă în care lotul supus lipsei de apă (L2) a fost hidratat, s-a constatat o revenire în ceea ce privește valorile intensității la media de 3,44 Amp, fapt ce întărește relația dintre fenomenul de variație ale celor două caracteristici.*

**Cuvinte cheie:** *Solanum melongena*, umiditate, irigare

## INTRODUCTION

The genesis of this system is based on the intensity of an electric current measured between the two electrodes, intensity which is indirectly proportional to the water deficit measured at the level of the sap (Țenu, 2004; Apahidean and Apahidean, 2007; Asociația Inginerilor de Instalații din România, 2010). This paper positions plants as a co-ordinating elements in the irrigation assembly, where they can provide moisture data and can numerically convey the limits to which their biological systems works best. Thus, by using this system and implementing a software program that integrates all hardware, it is possible to control, through pilot plants, the whole crop irrigation activity and to obtain satisfactory results with the minimum of effort, as the definition of economy is given (Cismaru and Gabor, 2004; Indrea *et al.*, 2012; Stoleru, 2013).

## MATERIAL AND METHOD

The water supply of the plant was measured using two electrodes, represented by medicinal needles, treated to prevent oxidation during use (Bruzo *et al.*, 1999; Butnariu *et al.*, 1992). Previously, electrodes coated with gold or silver films were used, but they did not show satisfactory efficiency in the oxidation processes, reducing the contact surface of the sap with the conductive element, interfering in the electrical conductivity process and thus altering the data obtained for the system (Toma and Jităreanu, 2007; Palamaru *et al.*, 1997; Savu *et al.*, 2005). The  $\mu$ Current GOLD module is a precision adapter, created to extend the measurement range of traditional multimeters. With the adapter, values in the range of nanoamps or even picoamps can be determined, values that are required to be at this level to measure the intensity of the current, but without interfering or modifying in any way the normal physiological processes. To highlight low-intensity currents, a multimeter called galvanometer was used. It acts as a needle actuator, producing a rotary deflection in response to the electrical current flowing through the closed circuit.

## RESULTS AND DISCUSSION

On the third day of measurements, there was a slight decrease in the average of the values but this is irrelevant, the decrease being present in both lots, the average of the lot L1 being 6.25 Amps and the second lot having the value of 6.22 Amps .

At the fourth measurement, respectively on the fourth day, there is a more pronounced decline in the mean of the L2 lot, which is directly correlated with the lack of irrigation. The value of this median is 3.92 Amps.

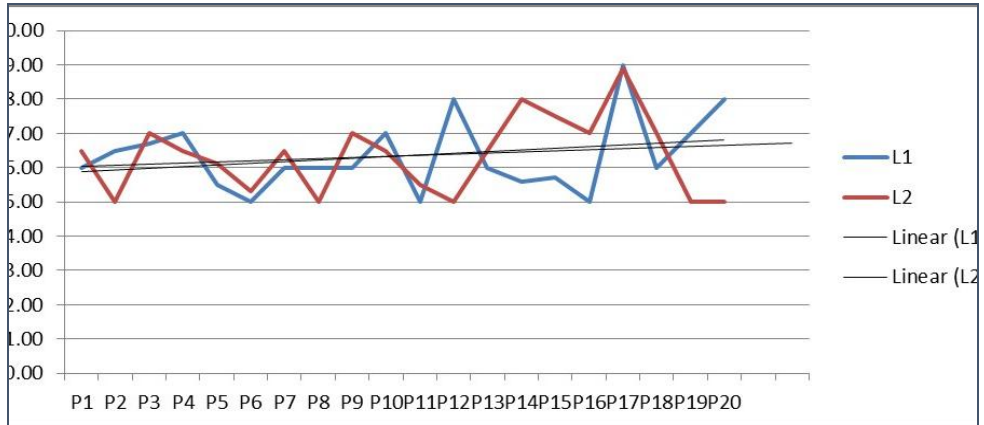


Fig. 1 Values measured in Day 1

On the fifth day, the average of the values obtained from the measurements is 2.54 Amps.

The sixth day shows an accentuated decrease in the values of the intensity, their average being at 1.67 Amps. These values prove the existence of the studied phenomenon, and extrapolating, we can say that the decrease will continue until the plant ceases to exercise physiological functions.

On the last day of the research stage (day 7), both batches were irrigated. At this point, there was a significant increase in the values of the electric current, which reinforces the above statements.

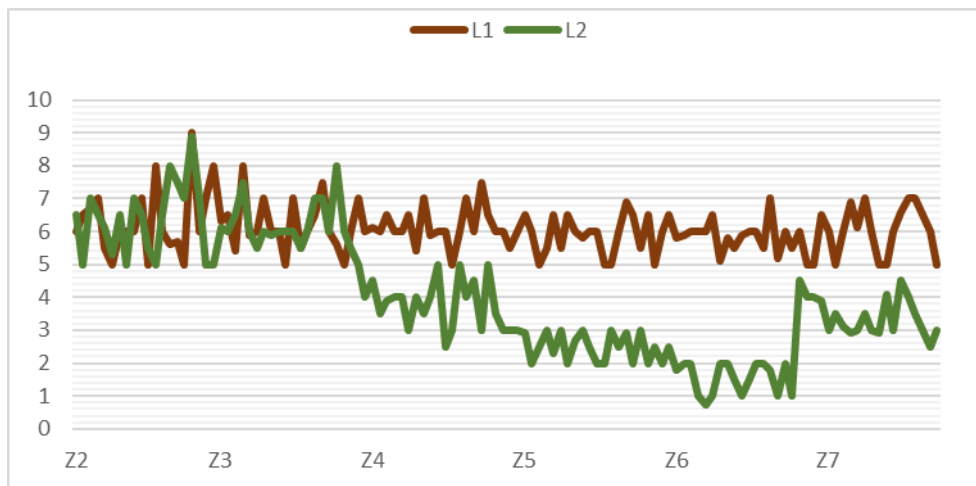


Fig. 2 Variation of the values of the two lots during the whole study period

## CONCLUSIONS

In conclusion, after studying the dynamics of the values, the functionality of the system can be asserted, the intensity gradient having a pronounced decrease between the third day and the sixth day, returning to the initial values when the water saturation condition was fulfilled. Based on the outlined aspect of the two broad lines of the two lots, software can successfully implement an irrigation system that does not depend on the coordination of a human or preprogrammed element.

**ACKNOWLEDGMENT:** *This paper was supported by the project PN-III-P1-1.2-PCCDI-2017-0560 (no. 41/2018) financed by UEFISCDI.*

## REFERENCES

1. **Apahidean S., Apahidean M., 2007** - *Cultura legumelor*. Editura Ceres, București.
2. **Burzo I., Toma S., Craciun C., Voican V., 1999** - *Fiziologia plantelor de cultură*. Editura Întreprinderea Editorial-Poligrafică „Știința”, Chișinău.
3. **Butnariu H, Indrea D., Petrescu C., Savițchi P., Peleaghia C., Ciofu R., Popescu V., Radu G., Stan N., 1992** - *Legumicultură*. Editura Didactică și pedagogică, R.A.I București.
4. **Cismaru C., Gabor V., 2004** - *Irigații. Amenajări, reabilitări și modernizări*. Editura Politehniun, Iași.
5. **Indrea D., Apahidean A., Apahidean M., Măniuțiu D., Sima R., 2012** - *Cultura legumelor*. Editura Ceres, București.
6. **Palamaru M.N., Iordan A. R., Cecal A., 1997** - *Chimie bionaorganică și metalele vieții*. Editura BIT, Iași.
7. **Savu P., Bucur D., Jităreanu S.I., 2005** - *Îmbunătățiri funciare și irigarea culturilor*. Editura „Ion Ionescu de la Brad” Iași, Iași.
8. **Stolneru V., 2013** - *Managementul sistemelor legumicole ecologice*. Editura „Ion Ionescu de la Brad”, Iași.
9. **Toma C., Niță M., 1995** - *Celula vegetală.*, Editura Universității „Al. I. Cuza”, Iași.
10. **Toma D., Jităreanu D., 2007** - *Fiziologie vegetală*. Editura „Ion Ionescu de la Brad”, Iași.
11. **Țenu I., 2004** - *Echipamente pentru irigații*. Editura Tehnică, Științifică și Didactică CERMI, Iași.
12. **\*\*\*, Asociația Inginerilor de Instalații din România, 2010** - *Manualul de instalații*. Editura Artecno, București.

## PRELIMINARY RESULTS REGARDING ELECTROSTIMULATION OF THE PHYSIOLOGICAL RITHM BY USING CONTINUOUS ELECTRIC CURRENT IN PEPPER CROPS

### REZULTATE PRELIMINARII PRIVIND ELECTRO-STIMULAREA RITMULUI FIZIOLOGIC PRIN UTILIZAREA CURENTULUI CONTINUU LA ARDEIUL GRAS

**GHEORGHİȚOAI E M.<sup>1</sup>, ACHIȚEI V.<sup>1</sup>, TELIBAN G.C.<sup>1</sup>, STOLERU V.<sup>1\*</sup>**

\*corresponding author: vstoleru@uaiasi.ro

**Abstract.** *The goal of this research was to study the usefulness of the continuous current in a sweet pepper crop, the process that aims to accelerate the rhythm of flowering, fructification and ripening, obtaining more early harvests in conditions of food safety that does not affect consumers' health. Thus, by connecting the plant to a continuous current that will generate a negatively charged magnetic field, it stimulates the absorption from the soil of the essential mineral elements in terms of good development of plant growth and development. The method consists in creating a flow of electrons circulating from the plant's base to the top. This field that will be loaded in turn with negative electrical load, has the property to attract positively charged electrical loads. The most favourable results were achieved in the case of a continuous current of 1.5 V, the positive pole being located in the apical area, and the negative one being inserted at the base of the plant's stem.*

**Key words:** electrical current, electrostimulation, physiological rhythm

**Rezumat.** *Scopul acestei cercetări a fost acela de a studia utilitatea curentului continuu la o cultura de ardei gras, procedeu prin care se dorește accelerarea ritmului de formare a florilor, fructificare și maturare, obținându-se recolte mult mai timpurii în condiții de siguranță alimentară care să nu afecteze sănătatea consumatorilor. Astfel, prin conectarea plantei la un curent continuu ce va genera la rândul său un câmp magnetic încărcat negativ se stimulează absorbția din sol a elementelor minerale cu rol esențial în ceea ce privește buna dezvoltare a creșterii și dezvoltării plantelor. Metoda constă în crearea unui flux de electroni care circulă de la baza plantei către vârf. Acest câmp care va fi încărcat la rândul său cu sarcină electrică negativă, are proprietatea de a atrage sarcinile electrice încărcate pozitiv. Rezultate favorabile au fost obținute în cazul aplicării unui curent continuu de 1,5 V, polul pozitiv fiind situat în zona apicală, iar cel negativ fiind inserat la baza tulpinii plantei.*

**Cuvinte cheie:** curent electric, electrostimulare, ritm fiziologic

## INTRODUCTION

As is already well known, a healthy and balanced diet is the key to getting a healthy body (Stoleru *et al.*, 2014; Caruso *et al.*, 2018). The need for food is due to the need

---

<sup>1</sup>University of Agricultural Sciences and Veterinary Medicine of Iasi, Romania



of the bodies to feed themselves with nutrients in order to obtain energy for their proper functioning (Munteanu, 2003; Voican and Lăcătuș, 2004).

Applying electricity, magnetism, monochrome light and sound can greatly stimulate plant growth. This little-known technology, called Electro-culture, can accelerate growth and improve product quality. Thus, farmers can get better, better quality produce in a shorter time, with less effort and at a lower cost. Most approaches to Electro-culture include static electricity, direct current and alternative. The energies are applied to seeds, plants, soil or water and nutrients (Black *et al.*, 2011; Artem, 2012; Novak *et al.*, 2013; Jeong, 2016).

In this context, the purpose of this paper is to use continuous electric current to improve the absorption of nutrients in the soil in order to obtain superior quality production in a shorter period of time.

## MATERIAL AND METHOD

The electrical current is characterized by the orderly movement of an electron stream into a conductor at a given moment under the action of an electric field. These electrons or wearers, as they are called by other authors, do not have a uniform straight rectilinear motion but have a chaotic motion, the accelerations and decelerations being multiple due to the collisions between the charge carriers of the electric current and the film that form the ions of the crystalline network of the conductor (Van Antwerpen and Franklin, 1954; Young and Ratcliffe, 1969).

Moving electric loads in one direction through some medium is called direct current. It can go through semiconductor environments, metal conductors, electrolytic solutions etc. (Young and Ratcliffe, 1969).

As is already well known, plants, to feed themselves, absorb water from the soil along with nutrients. This absorption is achieved both actively due to the phenomenon of sweating as well as passive through its own metabolic energy (Monet *et al.*, 1959; Zwiebel, 1975; Toma and Jităreanu, 2007). The part of the plant that fulfills the absorption roles as well as the primary synthesis of nutrients is the root.

The researches were held in the greenhouse UASVM Iasi, in a randomized block device, in three repetitions, five plants per repetition, Barbara using pepper variety.

Scheme of the sample operating principle where the yield indicating the possibility of a production capacity of a higher level as opposed to the other analyzed situations is shown in figure 1.



**Fig. 1** Operating principle in using 1.5 V continuous current

Thus, by connecting the plant to a direct current which will in turn generate a negatively charged magnetic field, it is desired to stimulate the absorption of mineral elements in the soil, which plays an essential role in the proper development of plant growth and development. Several samples were used in the experience: the appearance of flowers, the formation and evolution of pepper etc.

## RESULTS AND DISCUSSIONS

Measurements were made on several samples, three of the most representative determinations being presented below (tab.1).

In the case of the control variant, as can be seen from the data presented in the table, during the period of experience, a maximum of 64 flowers was obtained on 15 September and nine fruits on September 23, some of which were later aborted, at the end of the crop remaining a number of seven fruits.

Table 1

**Results on the number of flowers and fruits formed on plants**

Data	27	30	1	2	3	5	7	9	13	15	19	21	23	25	29	1	3	5	8	12	15	22
	Aug.		Sept.														Oct.					
Control																						
buds/flower	14	9	8	12	17	33	34	48	62	64	61	57	53	47	48	47	39	23	11	2	0	0
fruits	0	0	0	0	0	0	0	0	2	5	5	5	9	8	7	6	6	6	8	8	7	7
1.5 V in soil																						
buds/flower	13	13	11	11	15	35	40	42	45	44	40	40	36	40	33	30	25	15	7	3	0	0
fruits	0	0	0	0	0	0	0	0	2	5	7	7	5	6	6	6	5	5	5	7	6	6
1.5 V polarity																						
buds/flower	22	19	17	21	23	37	47	52	37	30	20	20	20	19	20	19	11	6	1	0	0	0
fruits	1	1	1	1	1	2	2	2	5	11	15	13	13	12	12	10	8	8	9	9	9	9

In the experience where a 1.5 volt current at ground level has been used, the maximum flowering potential has been achieved by forming 45 flowers (September 13) and tethering seven fruits (September 19). The variation in the number of flowers formed in this sample shows a fairly large amplitude of the total number of flowers formed by linking only seven fruits at the time of fructification, but there were also abortions, leaving only six fruits at the end of the experiment.

If the same 1.5 V current is used, but the poles of the electrical loads are connected one to the base of the package and the other in the apical area has been found to have obtained a fruit from the first reading reaching a maximum number of 15 fruits (September 19) for a maximum of 52 flowers recorded on 9 September.

One reason why the number of aborted flowers and fruits was very high may be that the plants were grown on pots and the amount of soil was insufficient. However, the differences between the studied variants are obvious (fig. 2), with the best results being recorded for the 1.5 V continuous current, with the electric charge poles connected to the base of the package, and the other in the apical area.

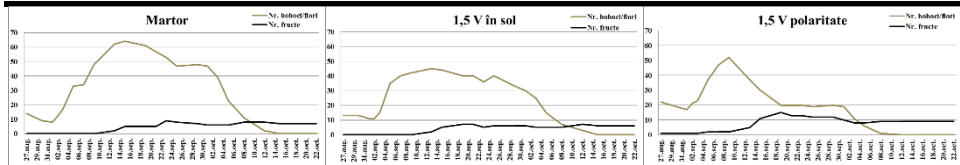


Fig. 2 Values mesured on different samples

## CONCLUSIONS

According to the obtained results, it can be stated that by using a continuous electric current, at low voltages, the metabolism of the plants can be stimulated by facilitating the absorption of nutrients in the soil and their assimilation at the cellular level.

Growth of plant production can be stimulated by continuous electric current, but more experiments are needed to better understand the phenomenon, this being a preliminary study.

**ACKNOWLEDGMENT:** *This paper was supported by the project PN-III-P1-1.2-PCCDI-2017-0560 (no. 41/2018) financed by UEFISCDI.*

## REFERENCES

1. Barinov Artem, 2012 – *The effect of electricity on plant growth*. Moscow.
2. Black J.D., Forsyth F.R., Fensom D.S., Ross R.B., 2011 – *Electrical stimulation and its effect on growth and ion accumulation in tomato plants*. Canadian Journal of Botany, vol. 49, no. 10, pp. 1809-1815. DOI: 10.1139/b71-255.
3. Caruso G., Stoleru V., Munteanu N., Sellitto V.M., Teliban G.C., Burducea M., Țenu I., Morano G., Butnariu M., 2018 – *Quality Performances of Sweet Pepper under Farming Management*. Notulae Botanicae Horti Agrobotanici, Cluj-Napoca, Romania, vol. 47, No: 2. ISSN: 0255-965X.
4. Jeong-Yeol Y., 2016– *Introduction to Biosensors*. Springer International Publishing. Elveția.
5. Monet Gilbet P., Baddour R.F., Juda W., 1959 –*Adsorption, Dialysis, and Ion Exchange*. Publishing house American Institute of Chemical Engineers, New York.
6. Munteanu N., 2003 –*Tomatele, ardeii și pătlăgelele vinete*. Editura „Ion Ionescu de la Brad”, Iași.
7. Novak V., Bjeliš M., Franković R.H., 2013 – *Effect of electricity on growth and development of several plant species*. Zagreb, Croatia.
8. Stoleru V., Munteanu N., Sellitto V.M., 2014 – *New approach of organic vegetable systems*. Publishing house Aracnee, Rome.
9. Toma D.L., Jitoreanu C.D., 2007 –*Fiziologie vegetală*. Editura „Ion Ionescu de la Brad”, Iași.
10. Van Antwerpen, Franklin J., 1954 –*Ion exchange*. Publishing house American Institute of Chemical Engineers, New York.
11. Voican V., Lăcătuș V., 2004 –*Cultura protejată a legumelor în sere și solarii*. Editura Ceres, București.
12. Young L., Ratcliffe, J.A., 1969 – *Systems of Units in Electricity and Magnetism*. Publishing house Oliver & Boyd, Edingurgh.
13. Zwiebel I., 1975 –*Adsorption and ion exchange*. Publishing house American Institute of Chemical Engineers, New York.

## CAN AGROFORESTRY SYSTEMS BE ORDINARY PRACTICES IN ROMANIA?

### SISTEMELE AGROSILVICE POT FI PRACTICI OBIȘNUITE ÎN ROMÂNIA?

POPOVICI L.<sup>1\*</sup>, MIHĂILĂ Elena<sup>1</sup>, COSTĂCHESCU C.<sup>1</sup>,  
CONSTANDACHE C.<sup>1</sup>,

\*Corresponding author e-mail: laursilva@yahoo.com

**Abstract.** Agroforestry system seems to be necessary in Romania because the climate has undergone important changes and some of ecosystems are degraded; agroforestry systems ensuring the long-term enhancement of environmental quality. There are some types of agro-forestry that can be applied in Romania, some have been applied to certain extent, others can be implemented for the first time. In the first category enters forestry shelterbelts for crops protection, pastures with trees, forestry shelterbelts for the protection of watercourses, the second includes other types of agroforestry systems among which it is presented a case study "agroforestry hunting system" which have been developed by smallholders farmers.

**Key words:** agroforestry, forest shelterbelts, "agroforestry hunting", support measures

**Rezumat.** Agro-silvicultura este necesar în România deoarece climatul a suferit schimbări importante și unele ecosisteme sunt degradate; sistemele agro-silvice asigurând îmbunătățirea pe termen lung a calității mediului. Există câteva tipuri de agro-silvicultură care pot fi aplicate în România, unele au fost aplicate într-o anumită măsură, altele pot fi implementate pentru prima dată. În prima categorie intră perdelele forestiere pentru protecția culturilor, pășuni cu arbori, perdele forestiere de protecție a protecția cursurilor de apă, în categoria următoare se includ alte tipuri de sisteme agro-silvice printre care este prezentat un studiu de caz privind "sistem agro-silvic pentru vânătoare" care a fost dezvoltat de către mici fermieri.

**Cuvinte cheie:** agrosilvicultură, perdele forestiere, "sisteme agrosilvice pentru vânătoare", măsuri de sprijin

## INTRODUCTION

According to the European Agroforestry Federation (EURAF), the main institution from Europe dealing with agroforestry, agroforestry means "the integration of woody vegetation, crops and/or livestock in the same area of land. Woody vegetation can be inside parcels or on the boundaries (hedges)". In Romania, agroforestry systems are an old practice (the combining the trees with crop and/or animals have been practiced over time, in various forms) and, in the same time, are a new concept (not fully understood and not perceived as independent science like in many countries in the world). The main types of

---

<sup>1</sup> "Marin Drăcea" National Institute for Research and Development in Forestry, Brașov, Romania

agroforestry systems find in Romania with ecological, economic and social impact are: forestry shelterbelts for crops protection, forestry shelterbelts for the protection of the main rivers, pastures with trees, taungya system. There are some other forms of association forestry vegetation and crops and/or animals such as: specialized farms on non-timber products (e.g. the harvesting of seeds, flowers from trees, honey by bee-keeping, mushrooms) or agroforestry hunting which have been developed through the initiative of some farmers and particularly smallholders. They have not yet a regional or national character but could be relevant for implementation of agroforestry system. (Mosquera-Losada *et al*, 2018).

## MATERIAL AND METHODS

In order to present a summary of the main types of agroforestry systems in Romania was based on the consultation of relevant works and on the results of its own researches.

For the majority of localities in the south of the country it has designed the forestry shelterbelts for crop protection. The forestry shelterbelts were placed using GIS-specific techniques. For practical reasons, the network of forestry shelterbelts was designed on the contour of the agricultural land, at average distances of approximately 600 m between the main forestry shelterbelts and 1200 m between the secondary forestry shelterbelts, with a width of 10 m.

Forest belts for protection of the water courses (riparian buffer strips) were designed by analysing of the main watercourses to show the area occupied with forest vegetation in a corridor of 1,5 km width of one side and another using the GIS method. After that we delimited the alluvial soils from the waterside (haplic fluvisols, dystric fluvisols, eutric cambisols). Within the area occupied by alluvial soils, they were divided the land areas without forest vegetation and those with forest vegetation were.

In the area of Nămolosa, Galati County, the territory at the confluence of the Lower Siret Plain in the north-eastern extremity of Romanian Plain and Siret Valley, a private entrepreneur has applied the following agroforestry system adapted to the requirements of hunting, namely, for the growth, spreading and "exploitation" of the pheasants, partridges and rabbits. They were chosen marginal land and / or marking the ditches and irrigation channels. The form of ownership has been agreed with owners or land exchange was used.

The structure and form of the combined crops have been established according to three functional criteria in relation to the requirements for the growth, development and harvesting of game (hunting) stock, and are presented below.

**Type 1:** The recovery by the chase of the stocks of hunting, grown and fed into agro-forestry strip areas. The system for capitalizing the game hunting is given the example of 1 year agro-forestry culture installed in November, 2017 (fig. 1).

Scheme black pine planting rows is 2.0 x 1.0 m. By turn, 3 pieces of black pine are interwoven with 5 specimens of shrubs of the species: rosehip, turkey cork, cherry-plum. The same interlacing system: 3 specimens of the main species with 5 seedlings of shrubs were also used on the black and honey locust for planting device where the planting pattern is 1.5 x 1.0 m. A corn harvest (unrecorded) was added to the forest culture and an alfalfa crop with red clover of the same width. The band created has a width of 31-32 m and a length of 600 m. Routine maintenance was performed with the manually trailed tillers. For the main species, the 4.0 x 1.0 m scheme was also chosen.

**Type 2:** The system for the growth and development of the stocks of hunting, providing protection areas for food and nesting, the way of realizing the agro-forestry

belts is the same (fig. 2). The changes occur in the arrangement of adjacent crops. Next to the belt, two strips with a width of 5 m are created with a biannual plant seed variety: in, mustard, coriander, poppy, hemp, millet chicory, sunflower, Calle cabbage, etc. After these two strips, continue with 2 strips of "big" crops: sunflower or maize (rotation at 2 years). In such areas, hunting is only allowed selectively for mature pheasants. These areas have also been created around the lofts of growth where pheasant chickens are raised intensively, until a certain age, after which these lofts are dismantled and their location moves.

**Type 3: Special system for breeding and development of partridges**

The agricultural part of the system is similar to Case 2, only the forestry component changes structurally (fig. 3). The rows with the main species in this case, the black and honey locust to which it was proposed mulberry tree, become central rows with planting scheme of 2.0 x 1.0 m, and on each side of this axis are planted 5 rows of shrubs with the scheme of 1.10 x 1.0 m.

## RESULTS AND DISCUSSION

**The forestry shelterbelts for crops protection** are the most visible type of agroforestry system promoted by government institutions (central public authorities, research institutes), without being supported by appropriate financial measures. Their achievement is done by both owners and administrators of agricultural land, pastures, farms, either individuals or companies.

The south (The Romanian Plain and Dobrogea), but also agricultural areas in the western and eastern parts of the country are affected by climate change. The analyzed areas are characterized by average annual temperatures of about 11<sup>0</sup>C, average annual precipitation below 500 mm and de Martonne aridity index between 20 and 23, thus the shelterbelts were designed to improve the conditions for the growth of crops, to increase fertility and soil conservation. In the southern area of the country, the network of forestry shelterbelts would cover about 87,200 ha, which will protect about 3,500,000 ha of agricultural lands (crops and pastures). This result in an approximate percentage of occupancy of agricultural land with forest vegetation of 2-3%. Different forest species were used such as *Quercus* sp. *Ulmus pumila*, *Fraxinus ornus*, *Pyrus pyraster*, *Tilia tomentosa*, *Eleagnus angustifolia*, *Acer platanoides*, *Prunus cerasifera*, shrubs have been used to ensure biodiversity. The forestry plantations to be installed within this agroforestry system will store an appreciable amount of carbon solution which comes in the context of efforts to reduce greenhouse gas content.

First researches and recommendations on the establishment of **forest belts for protection of the watercourses (riparian buffer strips)** (Siret, Ialomita, Arges, Olt, Jiu, Mures) have been made since the 50s of the last century.

The analysis of the main watercourses showed that the area occupied with forest vegetation in a corridor of 1.5 km width of one side and another is relatively small (ranging from 10.21% for the Siret River to 26.77 % in the case of the Jiu River). The small percentage of forest vegetation was due to its systematic removal and use of land for the extension of agricultural land or, recently for the development of living areas close to river. The lack of forest vegetation have a great ecological impact, increasing the share of agricultural land

near the watercourse. For instance, the areas where forest belts for water-protection are required vary from 124,054 ha (19.39%) for Mures River, to 3,702 ha (0.58%) for Tisa River (fig. 4).

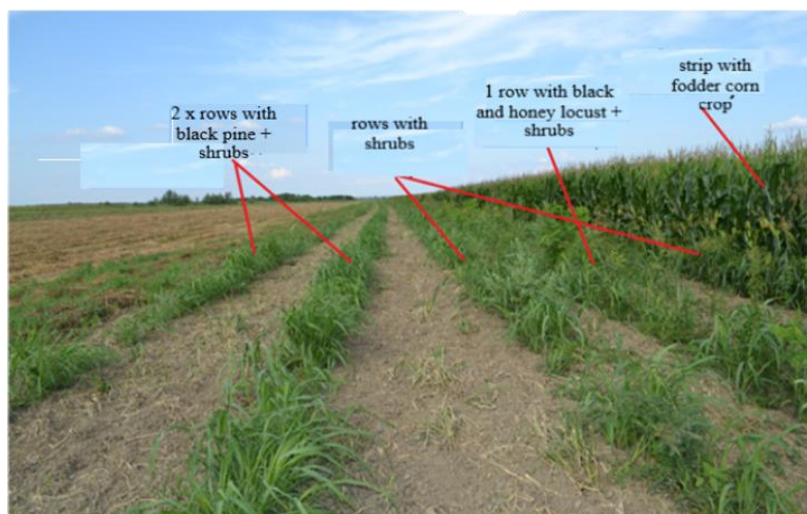
The first stage in the realization of forest belts for water protection consists in the particular analysis of each water course in terms of climatic and site conditions, the presence or absence of forest vegetation and the main functions of these forest protective belts (bank stabilization, filtering pollutants etc.).

**Pastures with trees**, the most representative type of silvopastoral systems have a long tradition in our country as in many other countries. During the period between the 50s and 80s of the last century, they developed in an organized manner, and the silvopastoral management followed to harmonize the economic, social and environmental requirements. Currently, many of them are degraded.

#### **Agroforestry Hunting System: Case Study**

**Type 1:** Replenishments will be done with black pine because this species through its low form ensures pheasant shelter against predators: jackal and fox. In the plantation executed in autumn 2016, in an intensive hunt with chase, were shot in the winter of 2017, 200 samples / day. At present, 3500 samples currently has on 150 ha, in which 20 ha of such crops have already been created. Harvest on this hunting fund was 1000 samples of pheasant in the conditions in which only 1100 samples were collected in the whole Galați County, in year 2017.

**Type 2 an 3.** Areas of feeding with biannual herbaceous plants and large crops remain unchanged as position and structure. Given that the current fund has a yield of 60-100 samples / year, is expected to reach the end, at a production of 15,000 - 20,000 samples./year, at the time of closure of the entire network.



**Fig. 1** Type of forest shelter-belt with crops to grown, feed and stock the pheasants for hunting





Fig. 2 The agro-forest system to growth and development the flocks of pheasants

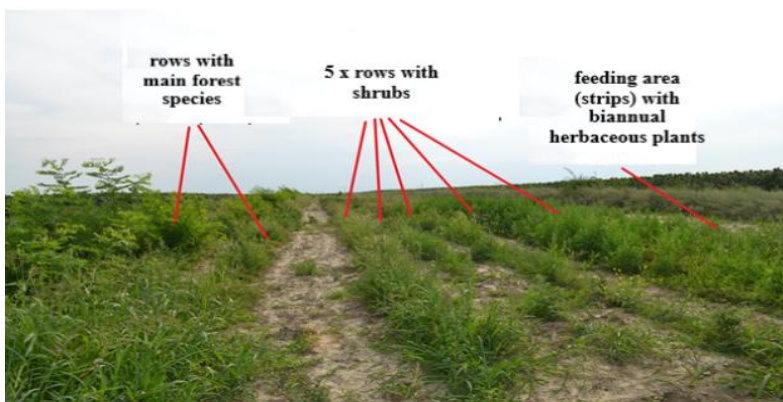


Fig. 3 The special agro-forest system for breeding and development of partridges

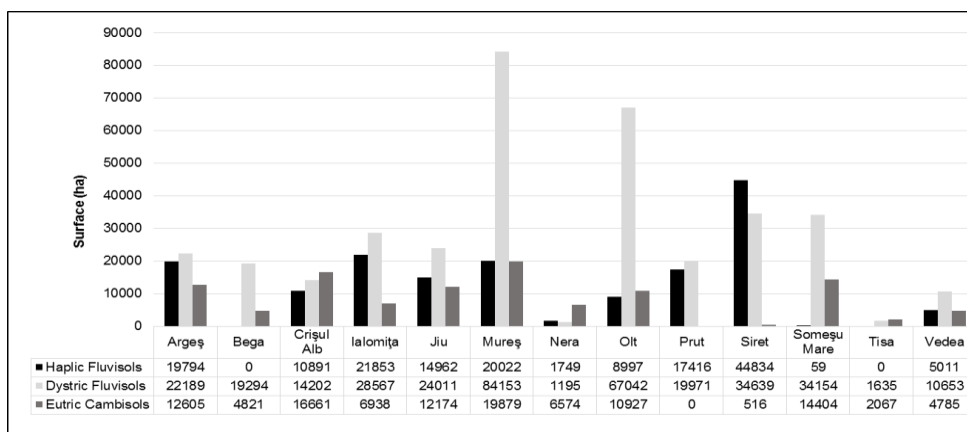


Fig. 4 Areas that need to be forested on a 1.5 km corridor both sides of main rivers (Costăchescu *et al.* 2010, Blujdea *et al.* 2012, Mihăilă *et al.* 2010, Ionescu *et al.* 1960, Sabău and Pană 1955, Motcă *et al.* 1994).



## CONCLUSION

At EU level there are measures to support agroforestry systems. Instead, in our country only some institutions (central public authorities, research institutes) and some people promote the agroforestry systems such as forestry shelterbelts for crop and water protection. There was a national project for studying agroforestry systems and there is another project on agroforestry systems in which there are intention to create certain models of agroforestry systems as a means of mitigate the effects of climate change. Higher education institutions with the forestry specialty also included agroforestry systems discipline in the curriculum. Very important is that some farmers and especially smallholders realised their own agroforestry systems.

But little has happened to support AGROFORESTRY from policy point of view. There are only one measure in our *National Rural Development Programme* which support the afforestation in agricultural land. In this case copses and forestry shelterbelts could get supports.

For the promotion of agroforestry systems it is necessary to implement some specific and clear financing support measures, followed by good practice manuals for their application. Landowners must be convinced that agroforestry systems are not supposed to replace stable, specialized and productive systems, but only to improve those that are less productive and located in drought areas.

## REFERENCES

1. **Blujdea V.N.B, Pilli R., Dutca I., Ciuvat L., Abrudan I.V., 2012** - *Allometric biomass equations for young broadleaved trees in plantations in Romania*. In *Forest Ecology and Management*, 264:172-184.
2. **Costăchescu C., Dănescu F., Mihăilă E., 2010** - *Protective forest shelter belts*. Forestry Publishing House (in romanian with summary in english), Bucharest, 262 pp.
3. **Ionescu A., Marcu Gh., Moisuc Gh., Lupe I. 1960** - *Research on the need for state shelter belts on water courses in P.R. of Romania*. In: *Studies and Research*, vol. XXI. Agro-Forest Publishing House (in romanian with summary in french and russian), pp:101-133
4. **Marușca T. 2006** - *The Agrosilvopasthoral System and its advantages.*, year VIII, no. 6 (44), (in romanian) Timișoara.
5. **Mihăilă E., Costăchescu C., Dănescu F., Drăgoi S., 2010** - *Agroforestry systems*. Forestry Publishing House (in romanian with summary in english), Bucharest, 190 pp.
6. **Mosquera-Losada M.R., Santiago-Freijanes J.J., Moreno G., den Herder M., Aldrey, J.A., Rois-Díaz M., Ferreira-Domínguez N., Pantera A., Rigueiro-Rodríguez A., 2018a**: - *Agroforestry definition and practices for policy makers*. În: *Proceedings of the 4th European Agroforestry Conference "Agroforestry as Sustainable Land Use"*.
7. **Motcă Gh., Oancea I., Geamănu L., 1994** - *The meadows of Romania*. Agricultural Technical Publishing House (in romanian with summary in english), Bucharest.
8. **Sabău V., Pană P., 1955** - *Silvopastoral arrangement*. In: *The Forest Engineer's Manual*. Technical Publishing House Bucharest (in romanian), vol. 81, pp. 292 – 306.

## BIOPESTICIDES A NEW CHALLENGE IN ASSURING FOOD QUALITY AND SUSTAINABLE AGRICULTURE

### BIOPESTICIDELE - O NOUĂ PROVOCARE PENTRU ASIGURAREA CALITĂȚII ALIMENTELOR ȘI PENTRU O AGRICULTURĂ SUSTENABILĂ

**DARABAN G.<sup>1</sup>, BADEANU Marinela<sup>2</sup>,  
RUSU Lăcrămioara<sup>3</sup>, SUTEU Daniela<sup>1\*</sup>**

\*Corresponding author e-mail: danasuteu67@yahoo.com

**Abstract.** *The pesticides represent one of the most toxic compounds that affect the human health, these compounds having mutagenic and carcinogenic effects. One of the way by these compounds can get into the human body are the food. The use of biopesticides in the plants growth is part of the concept of "sustainable agriculture". Various biologically active compounds from plant sources have been shown to exhibit high efficacy, multiple mechanism of action, low toxicity to mammals, which has led to increased the interest in using them as biopesticides in a stabilized form and easy to handle. The aim of this paper is the study of some vegetal extracts with potential repellent effect, from the spontaneous flora of Moldavia/Bucovina in combating the pests.*

**Key words:** biopesticides, cold extraction, vegetal extract, insecticide effect

**Rezumat.** *Pesticidele reprezintă compuși toxici care afectează sănătatea umană, având efecte mutagene și carcinogene. Una dintre căile prin care acestea pot ajunge în corpul uman o reprezintă alimentele. Utilizarea biopesticidelor în cultivarea și creșterea plantelor se înscrie și conceptului de "agricultură durabilă". Este cunoscut faptul că o serie de compuși biologic activi din surse vegetale prezintă eficacitate ridicată, mecanism multiplu de acțiune, toxicitate scăzută la mamifere, ceea ce a determinat un interes crescut pentru testarea/utilizarea lor ca și biopesticide într-o formă stabilizată și ușor de manevrat. Scopul lucrării este studiul unor extracte vegetale cu potențial efect repulsiv, din flora spontană a Moldovei/Bucovinei, în combaterea dăunătorilor.*

**Cuvinte cheie:** biopesticide, extracție la rece, extract vegetal, efect insecticid

## INTRODUCTION

With a rapidly growing technology, humanity is still at a crossroads generated by the food crisis, climate issues, and resource depletion. In this context, the concept of "sustainable development" is more appropriate than ever.

---

<sup>1</sup>"Gheorghe Asachi" Technical University of Iași, Romania

<sup>2</sup>University of Agricultural Sciences and Veterinary Medicine, Iasi, Romania

<sup>3</sup>"Vasile Alecsandri" University of Bacau, Romania

People want to live a quality life, which means living conditions ensured by a friendly environment and a proper diet that contributes to preserving health. In this context, attention is paid not only to the technologies of processing vegetable and animal matter in the food industry, but also to the production of these materials, respectively to the practice of agriculture as a whole (Roman and Benelli, 2010; Béjaoui *et al.*, 2013). Ensuring the quality of food intended for consumption is possible if a rigorous control of the quality of all stages involved is carried out along the food chain (Suteu *et al.*, 2010). A defining stage in ensuring the quality of food is the conditions of the production of raw material, whether vegetal or animal. Also, people have become self-aware with their own bodies, especially ensuring and maintaining the health and the quality of their lives. In this context, there is this increasing tendency towards the consumption of safety products (without emerging chemicals).

The pesticides represent one of the most toxic compounds that affect the human health, these compounds having mutagenic and carcinogenic effects. One of the way by these compounds can get into the human body are the food.

The use of *biopesticides* in the cultivation and growth of plants is part of the concept of "sustainable agriculture". So, more and more research data show that a growing number of essential oils have been tested against a wide range of arthropod pests with promising results (Zoubiri and Baalouamer, 2014; Bett *et al.*, 2017; Singh and Kaur, 2018; Upasani *et al.*, 2003; Morar *et al.* 2008; Brudea and Ciucă, 2007). Various biologically active compounds from plant sources have been shown to exhibit high efficacy, multiple mechanism of action, low toxicity to mammals, which has increased the interest in using them as biopesticides in a stabilized form and easy to handle.

There are a number of products of vegetable origin, mainly used in vegetable growing, obtained from tobacco leaves but also from other plants. The most representative are: Nicotine, obtained from (*Nicotiana rustica*) Anabasină from (*Anabasis aphylla*), quasină from (*Quasina amara*), rotenone from (*Derris elliptica*) and pyrethrin obtained from *Pyrethrum coccineum*, (Morar *et al.* 2008).

Obtaining some metabolites from local plant sources can be made by various extraction techniques solid - liquid (Cascaval D. *et al.*, 2004; Chua, 2013), depending on the nature of the vegetal material, the direction of use of the extract, process cost, availability of equipment.

The Colorado potato beetle (*Leptinotarsa decemlineata* Say.) is a devastating pest in vegetable crops *Solanaceae* class. Currently, it is being combated exclusively by chemical products, which have a reasonable efficacy on the pests but have the side effect on the fauna and flora in that geographic area, being rather aggressive. Also, the repeated use of chemical treatment leads to the emergence of resistance in time. In order to reduce the amount of chemical pesticides administered to control the Colorado beetle (*Leptinotarsa decemlineata* say), as an alternative solution, various vegetal extracts can be used, because they proved effective at least as well as synthetic pesticides (Morar *et al.* 2008).

Some plants from spontaneous flora can be used as ecological remedies for combating harmful coleoptera, without requiring cultivation or growth costs, on the one hand, and on the other, without endanger the equilibrium of the ecosystem because these plants are native.

The aim of this paper is the study the behaviour of some vegetal extracts with potential repellent effect, predominantly from the spontaneous flora of Moldavia and Bucovina and the investigation of their effectiveness in combating the pests. The plants that have been targeted in this study are: *Salvia officinalis*, *Ocimum basilicum*, *Satureja hortensis*, *Origanum vulgare*, *Primula veris*, *Equisetum arvense*, *Urtica dioica*, *Allium sativum*, *Pimpinella anisum*, *Matricaria chamomilla*, *Calendula officinalis*, *Achillea millefolium*, *Hypericum perforatum*, *Rumex patientia*. The extracts obtained will be tested on Colorado beetle (*Leptinotarsa decemlineata* Say) an insect of the coleopteran order, from the *Chrysomelidae* family, widely spread worldwide, associated with the potato culture on which it acts as a pest .

## MATERIAL AND METHOD

### Materials

It were used several lots of adults of *Leptinotarsa decemlineata* say and their larvae in various stages of development harvested from potato crops in Suceava County.

The plants selected in this study come from the spontaneous flora characteristic of Moldavia, the Bucovina area : *Salvia officinalis*, *Ocimum basilicum*, *Satureja hortensis*, *Origanum vulgare*, *Primula veris*, *Equisetum arvense*, *Urtica dioica*, *Allium sativum*, *Pimpinella anisum*, *Matricaria chamomilla*, *Calendula officinalis*, *Achillea millefolium*, *Hypericum perforatum*, *Rumex patientia*.

As solvent for solid-liquid extraction was used ethylic alcohol 96 % concentration with analytical grade purity.

### Method: extraction methodology

A very simple and used solid-liquid extraction technique is the maceration. It was practically achieved by suspending the solid in 96% alcohol, considering a 1:10 solid: alcohol ratio. It were used 10 g of dry plant (inflorescence and / or strains), chopped or milled, which were placed in an experimental installation with 100 mL of ethylic alcohol. The mixture was kept under intermittent stirred at room temperature (15-20°C). After reaching the established time, it was made the extracts phase separation and storage the liquid phases in a tight containers in a cool place.

### Preliminary test insect

The solutions that were used in the experiments were prepared with a concentration of 100% from the prepared extracts and were sprayed a populations consist of 10 adults and 10 larvae of *Leptinotarsa decemlineata* Say. placed in enclosures with different volumes (0.5L or 5L, respectively) and fed with green plants. Monitoring was done periodically after a set timetable: at 2h, 12h, 24, 48, and 72h, following the mortality index, behavior, the occurrence of pits. The experiments with the 14 extracts were done in duplicate, with a blank test (simple alcohol spraying).

Also, in the case of extracts with notable effects, experiments on new individuals were resumed, experiments that were repeated twice.

## RESULTS AND DISCUSSIONS

The obtained alcoholic extracts presented flavors specific to the plant from which they came, and different colours from green to yellow very light. The color and consistency of the liquid phases depend on the part of the plant introduced in the process of the extraction.

The results of the monitoring of *Leptinotarsa decemlineata* Say. behaviour are systematized in table 1.

Table 1

The effects of vegetal extracts on evolution and behavior of *Leptinotarsa decemlineata* Say.

Type of extracts	The percent (%) of deaths recorded by the number of hours since the first spraying including adults (A) and larvae (L)									
	2h		12h		24h		48h		72h	
	A	L	A	L	A	L	A	L	A	L
<i>Satureja hortensis</i>	0	0	0	0	0	0	10	0	10	20
<i>Ocimum basilicum</i>	0	0	0	0	20	0	0	0	0	0
<i>Origanum vulgare</i>	0	0	0	0	0	0	10	30	10	10
<i>Hypericum perforatum</i>	0	0	0	0	10	10	10	30	0	0
<i>Rumex patientia</i>	0	0	0	0	0	0	0	0	0	0
<i>Achillea millefolium</i>	0	0	0	0	0	25	0	0	10	10
<i>Calendula officinalis</i>	0	0	0	0	0	0	0	0	0	0
<i>Matricaria chamomilla</i>	0	0	0	0	0	0	0	0	0	0
<i>Salvia officinalis</i>	0	0	0	0	10	0	20	0	0	0
<i>Pimpinella anisum</i>	0	0	0	0	10	10	0	0	10	10
<i>Equisetum arvense</i>	0	0	0	0	0	0	0	0	0	10
<i>Allium sativum</i>	0	0	0	0	0	0	10	0	20	0
<i>Urtica dioica</i>	0	0	0	0	10	10	0	0	10	0
<b><i>Primula veris</i></b>	<b>90</b>	<b>80</b>	<b>10</b>	<b>10</b>	-	<b>10</b>	-	-	-	-
Blank sample	0	0	0	0	0	0	0	0	10	0

Analyzing the data from table 1 it can conclude that the manifestations recorded in the range of 0-2 h are normal, adaptive because the insects are installed in other living conditions than the natural ones. After two hours of application of the treatments, a series of clear neuroleptic manifestations of different intensity, depending on the plant from which the extract was performed, appear. These are: hyperexcitability, lack of coordination in space, partial paralysis with spasms of the appendages (wings, limbs, antennae, etc.) and end up to total paralysis and then death of individuals.

The study and analysis the data in Table 1 emphasizes that the *Primula veris* L. extract induced a mortality of 100% after 48-72h. The *Equisetum arvense*

L. extract causes late neuroleptic manifestations, and anise, chamomile, marigolds and rocks induce dynamism, so they are not important for the present study.

## CONCLUSIONS

The use of plant extracts from native plants may be an alternative to obtaining organic crops. The obtaining the extracts by the maceration technique, using ethylic alcohol as solvents accepted by the agriculture and food industry, is a simple and relatively cheap option and ensures interesting results with potential for practical application.

A range of spontaneous flora plants can be effective in combating harmful coleopterans and can be used in biological control of the Colorado beetle - *Leptinotarsa decemlineata* Say (*Coleoptera*, *Chrysomelida*).

The best results for controlling *Leptinotarsa decemlineata* Say. were obtained using *Primmula veris* extract with an efficacy of 80% after the first 24 hours after spraying and 100% after the 48 hours after administration.

The use of plants extract with insecticid properties in pest control could be a useful method firstly for small farmers who apply the principles of bio-dynamics agriculture.

Biopesticides may represent a opportunity for farmers which gives attention to environmental protection (especially the soil protection) and want to obtain cultures with a low degree of chemical contamination.

## REFERENCES

1. Bett P.K., Deng A.L., Ogendo J.O., Kariuki S.T., Kamatenesi-Mugisha M., Mihale J.M., Torto B., 2017 - *Residual contact toxicity and repellence of Cupressus lusitanica* Miller and *Eucalyptus saligna* Smith essential oils against majore stored product insect pests. *Industrial Crops&Products*, 110, p. 65-74.
2. Béjaoui A., Boulila A., Boussaid M., 2013 - *Chemical composition and biological activities of essential oils and solvent extracts of Origanum vulgare subsp. Glandulosum Desf. from Tunisia*. *Journal of Medicinal Plants Research*, 7(32), pp. 2429-2435.
3. Brudea V., Risca I.M., Enea C., Tomescu C.V., 2012 - *Efficacy of some biopesticides and plant secondary metabolites against fall webworm Hyphantria Cunea drury (F. Actiidae – Lepidoptera) in the lab.conditions*. *Cercetari Agronomice in Moldova*, XLV(1) (149), p. 73-80.
4. Brudea V., Ciucă C., 2007 - *Cercetări privind eficacitatea bio-pesticidului Spinosad în combaterea trombarului puieților de molid Hylobius abietis L. (O. coleoptera – F. curculionidae)*. *Analele Universității „Stefan cel Mare” Suceava, Secțiunea Sivicultură, Serie, 1*, p1-7.
5. Cascaval D., Oniscu C., Galaction A.I., 2004 - *Inginerie Biochimică și Biotehnologie.3. Procese de separare*. Editura Performantica, Iași.
6. Chua L. S., 2013 - *A review on plant-based rutin extraction methods and its pharmacological activities*. *Journal of Ethnopharmacology*, 150, p. 805–817.
7. Morar G., Sârbu C., Oltean I., 2008 - *Efectul extractelor hidroalcoolice din plante asupra gândacului de Colorado (Leptinotarsa decemlineata say.)*. *ProEnvironment*, 2, p. 101-104.

8. Roman P., Benelli G., 2016 - *Essential Oils as Ecofriendly Biopesticides Challenges and Constraints Trends*. Plant Science, 21 (12), p.1000-1007.
9. Singh B., Kaur A., 2018 - *Control of insect pests in crop plants and stored food grains using plant saponins: A review*. LWT- Food Science and Technology, 87, 93-101.
10. Suteu D., Zaharia C., Bădeanu M., Rusu G., 2010 - *Modern agriculture – key issue for guarantee of food safe?*. Proceeding of the 14<sup>th</sup> International Eco-Conference and 6th SAFE FOOD, Novi Sad, Serbia, 22-25 September 2010, p. 191-197
11. Upasani S.M., Kotkar H.M., Mendki P.S., Maheshwari V.L., 2003 - *Partial characterization and insecticidal properties of Ricinus communis L foloage flavonoids*. Pest Manag.Sci., 59, p.1349-1354.
12. Zoubiri S., Baaliouamer A., 2014 - *Potentiality of plants as source of insecticide principles*. Journal of Saudi Chemical Society, 18, p. 925-938.

## A MATHEMATICAL MODEL OF BACTERIAL GROWTH USING SOIL BACTERIAL COMMUNITIES

### UN MODEL MATEMATIC AL CREȘTERII BACTERIILOR UTILIZÂND COMUNITĂȚILE BACTERIENE DIN SOL

**BULGARIU E.<sup>1</sup>, CHIRUȚĂ C.<sup>1\*</sup>, CĂLIN M.<sup>1</sup>, LIPȘA F.D.<sup>1</sup>,  
GAFENCU A.M.<sup>1</sup> ULEA E.<sup>1</sup>**

\*Corresponding author e-mail: e-mail: kyru@uaiasi.ro

**Abstract.** A bacterial growth model is presented starting from the Malthusian model of exponential growth. Considering the growth rate being a linear function, we can express it using the bacterial tolerance grade over different conditions. Resolving the obtained differential equation, we plot the growth of the bacterial population for the studied initial conditions. The numerical increase of soil bacterial population cultivated on common microbiological growth media (Potato dextrose agar – abbreviated PDA) is studied.

**Key words:** mathematical model, bacterial growth

**Rezumat.** Un model de creștere bacteriană este prezentat pornind de la modelul malthusian de creștere exponențială. Având în vedere că rata de creștere este o funcție liniară, o putem exprima folosind gradul de toleranță bacteriană în diferite condiții. Rezolvând ecuația diferențială obținută, am calculat creșterea populației bacteriene pentru condițiile inițiale studiate. Creșterea numerică a populației bacteriene din sol cultivată pe medii comune de creștere microbiologică (Potato dextrose agar – abreviată PDA) este studiată.

**Cuvinte cheie:** model matematic, evoluția numărului de bacterii

## INTRODUCTION

Bacteria are prokaryotic organisms and represent the most widespread form on the planet. Some bacteria positively affect human and animal life and others have a negative effect. That's why studying this form of life is a necessity. Part of this study is represented by the way to grow bacterial cultures, the factors that influence this growth, and the ability to predict numerical growth by making models as close to reality as possible.

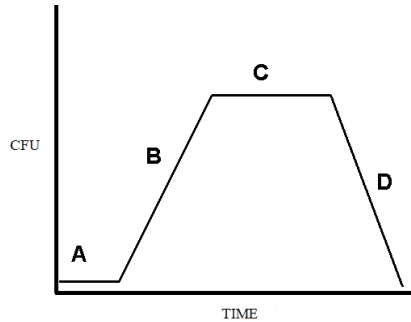
There are four phases in increasing the growth of a bacterial population (fig. 1): **(A)** *adaptation to the environment* and maturation in order to prepare for the beginning of the division (does not increase the number of bacteria), **(B)** *exponential growth* of the number of bacteria by their periodic division, **(C)** the *stationary* phase (the rate of colony growth becomes zero primarily due to the limited development area and the amount of food that is inversely proportional to the population) and **(D)** the phase of *decreasing* of the number of colonies by their

---

<sup>1</sup>University of Agricultural Sciences and Veterinary Medicine Iasi, Romania



death caused by environmental toxicity produced by them and lack of food (Koch *et al.*, 1998; Monod, 1942)



**Fig. 1** Phases of the growth of a bacterial population

A mathematical model of the growth of bacterial communities provides a stylized framework in which we can quantitatively study the rate of increase or decrease in the bacterial population according to the conditions under consideration. Differential equations or differential equation systems are typically used to characterize the development of bacterial communities (Murray, 2001)

### The mathematical model of the increase in the number of bacteria

It is known that each cell divides on average with a constant growth rate. Thus, the simplest mathematical model for increasing the number of bacteria is the Malthusian model (Koch, 2001; Burdujan, 1999; Smith and Waltman, 1995).

$$(1) \quad \frac{dN}{dt} = r \cdot N,$$

where  $N$  represents the number of bacteria at a given time and  $r > 0$  is a constant that signifies the *growth rate* that is specific to the type of bacterium. This model states that the rate of increase in bacterial counts is proportional to the number of cells ( $N$ ) at a given time and the growth rate ( $r$ ). In addition to equation (1), the initial conditions are also given

$$(2) \quad N(0) = N_0.$$

The solution of the model given by (1) and (2) is

$$(3) \quad N(t) = N_0 e^{rt}$$

and the doubling time of the number of bacteria (i.e.  $2N_0 = N_0 e^{rT}$ ) is calculated as being

$$(4) \quad T = \frac{\ln 2}{r}.$$

This expresses the exponential increase in the number of bacteria. As long as  $t \rightarrow \infty$  there is no upper barrier. This approach can be accepted if the field of development of the bacteria is unlimited compared to the size of the colony, the

amount of food is unlimited and the toxicity caused by the increasing number of bacteria is neglected. Obviously, these conditions are not realistic. In fact, as bacteria multiply, the amount of food decreases and the degree of environmental toxicity increases. These considerations lead us to the next idea: the more the bacteria population increases, the faster the rate of growth decreases. Thus, we will further consider that growth rate is a function that depends on the number of bacteria:

$$(5) \quad \frac{dN}{dt} = f(N) \cdot N.$$

We can consider that equation (1) gives an intrinsic property of bacterial culture and equation (5) is the result of all environmental restrictions [4]. Real growth is a combination of the two equations, so the model will contain an equation of the form

$$(6) \quad \frac{dN}{dt} = r \cdot N \cdot f(N).$$

For simplicity, we will consider the function  $f(N)$  as being linear, that is  $f(N) = aN + b$ . In order to determine the coefficients  $a$  and  $b$ , we take into consideration some particular cases (Burdujan, 1999; Smith and Waltman, 1995).

If  $N$  is very small ( $N \rightarrow 0$ ), one can consider the area of the culture to be infinite (compared to the size of the bacterium) and thus the equation (1) shapes population growth well. In these conditions  $f(N)$  is approximated by 1 (from equation (6)), thus  $b = 1$ .

We consider  $k$ , a new constant specific to each type of bacteria, namely, the *degree of tolerance* for decreasing the amount of food and the accumulation of toxins. If the bacteria exhibit great tolerance ( $k$  is big), the decrease of  $\frac{dN}{dt}$  with the increase of  $N$  is slow, which is associated with a negative slope of the function  $f$ , thus  $a < 0$ . If the tolerance is low ( $k$  is small), then the decrease of  $\frac{dN}{dt}$  is steep, so we can consider  $a = -\frac{1}{k}$ . Thus, the model obtained is

$$(7) \quad \begin{cases} \frac{dN}{dt} = r \cdot N \cdot \left(1 - \frac{N}{k}\right) \\ N(0) = N_0 \end{cases}$$

The equation in this model is known in the literature as the logistic equation. This differential equation is with separable variables and the equilibrium is obtained by imposing  $\frac{dN}{dt} = 0$ , which leads to

$$(8) \quad 0 = r \cdot N \cdot \left(1 - \frac{N}{k}\right)$$

with the solutions  $N = 0$  and  $N = k$ . Thus, we can associate another meaning to the constant  $k$  as being the maximum number of bacteria that can occur in the population. Solving the system (7) we get the solution

$$(9) \quad N t = k \left( 1 - \frac{1}{1 + C e^{rt}} \right),$$

where  $C = \frac{N_0}{k - N_0}$ . We have the growth rate of the population  $\frac{dN}{dt} > 0$  when

$0 < N < k$ , thus the function  $N t$  is increasing converging to  $k$  when  $t \rightarrow \infty$ .

When  $N > k$ , the function  $N t$  decreases toward  $k$ , for  $t \rightarrow \infty$ . The function graph (9) is called a growth curve and is in the form of the letter "S".

## MATERIAL AND METHOD

In the experiment we used soil from V. Adamachi farm, apple plantation.

The required soil was taken from some points taken on the diagonal of the apple plantation plot, from the depth of 5-7 cm. For planting, the method of successive dilutions (tubes of 9 ml each of distilled and sterilized water, prepared in advance) was used. From the soil sample, one gram was taken and introduced into the first test tube resulting in  $10^{-1}$  dilution. The solution was well homogenized and then, with a sterilized Pasteur pipette, 1 ml of solution was transferred to the second tube resulting in dilution of  $10^{-2}$ . This procedure was performed until the  $10^{-4}$  dilution was obtained.

From dilutions  $10^{-3}$  and  $10^{-4}$ , 1 ml of solution was taken and transferred into Petri dishes. Over 20 ml of PDA culture medium (Potato dextrose agar) was poured over this solution. We waited for the solidification of the medium (about 2 hours) after which they were placed in the incubator (28 degrees Celsius). For each dilution 5 pots were planted (fig. 1). From the moment of the first colonies, the number of colonies was determined on an hourly basis.

## RESULTS AND DISCUSSIONS

The experiment resulted in two sets of data that we have accumulated in tables 1 and 2. These data were used to compare the theoretical and practical results (fig. 2).

Table 1

Results obtained using a  $10^{-3}$  dilution

	1 <sup>st</sup> det	2 <sup>nd</sup>	3 <sup>rd</sup>	4 <sup>th</sup>	5 <sup>th</sup>	6 <sup>th</sup>	7 <sup>th</sup>	8 <sup>th</sup>	9 <sup>th</sup>	10 <sup>th</sup>	11 <sup>th</sup>	12 <sup>th</sup>	13 <sup>th</sup>
	8h	9h	10h	11h	12h	13h	14h	15h	16h	17h	18h	19h	20h
V1	10	86	161	245	291	321	351	372	381	392	464	509	545
V2	15	68	159	204	217	228	250	274	280	296	375	406	429
V3	8	61	148	184	226	253	273	288	296	309	359	384	400
V4	6	85	170	207	235	265	290	308	318	329	368	402	410
V5	4	67	134	178	213	247	266	281	294	312	353	374	387

Table 2

Results obtained using a 10<sup>-4</sup> dilution

	1 <sup>st</sup> det	2 <sup>nd</sup>	3 <sup>rd</sup>	4 <sup>th</sup>	5 <sup>th</sup>	6 <sup>th</sup>	7 <sup>th</sup>	8 <sup>th</sup>	9 <sup>th</sup>	10 <sup>th</sup>	11 <sup>th</sup>	12 <sup>th</sup>	13 <sup>th</sup>
	8h	9h	10h	11h	12h	13h	14h	15h	16h	17h	18h	19h	20h
V1	8	9	10	11	12	13	14	15	16	17	18	19	20
V2	0	3	27	33	37	39	47	54	58	65	80	82	87
V3	0	5	46	60	64	76	85	94	97	106	115	118	122
V4	0	0	27	40	46	50	56	59	63	69	79	82	84
V5	0	4	36	40	44	49	54	59	61	68	82	87	89

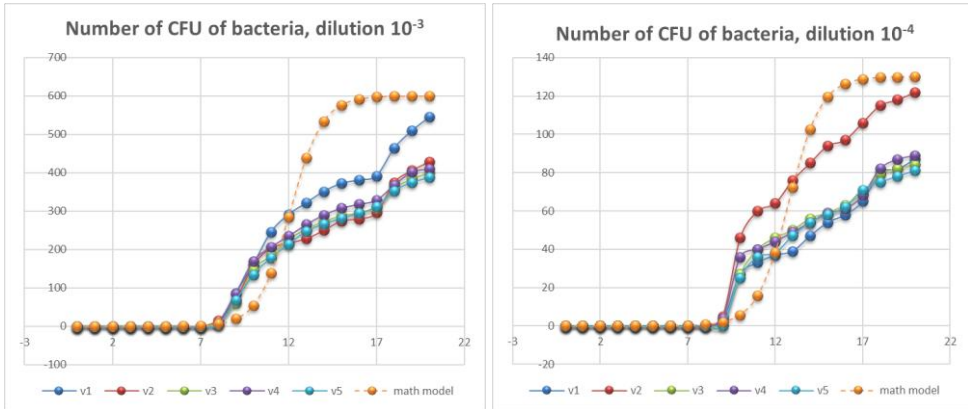


Fig 2 Bacteria number evolution (CFU 10<sup>-3</sup> (left) and CFU 10<sup>-4</sup>(right))

The values corresponding to the mathematical model were calculated according to solution (9):

$$N t = k \left( 1 - \frac{1}{1 + Ce^{rt}} \right).$$

For time  $t$  we considered values between 0 and 20 hours. The growth rate  $r$  specific for these bacteria was calculated as the average of successive growth ratios, so we considered  $r = 1.1$ . The initial condition was taken as the dilution grade: for the first experiment  $N_0 = 0.001$ , and for the 10<sup>-4</sup> dilution we considered  $N_0 = 0.0001$ . In order to compare the results (mathematical model / experimental data), the constant  $k$  was taken into consideration in relation to the maximum number of colonies of bacteria resulted in the two dilutions: at 10<sup>-3</sup> we considered  $k = 600$  and for 10<sup>-4</sup> we considered  $k = 140$ . The constant  $C$  was calculated by

the formula  $C = \frac{N_0}{k - N_0}$ .

## CONCLUSIONS

1. Using the experimental data obtained we calculated the bacterial population growth rate and the growth of a bacterial population in the soil was simulated using the mathematical model (logistic equation)

2. The bacterial growth model follows the mathematical model. The data obtained by mathematical simulation and the data obtained by experimental measurement are substantially equal to the t student test ( $p = 0.55$ ) for a  $10^{-3}$  and  $10^{-4}$  dilution.

3. Only the first three phases of the development of a bacterial population were investigated, without taking into account the decreasing number of colonies.

## REFERENCES

1. Burdujan I., 1999 - *Matematici cu aplicații în biologie*, Ed. Ion Ionescu de la Brad Iași.
2. Koch A.L., 2001 - *Bacterial Growth and Form*, Springer, Dordrecht.
3. Koch A.L., Robinson J.A., Milliken G.A., 1998 - *Mathematical Modeling in Microbial Ecology*, Chapman & Hall, Springer New York.
4. Monod J., 1942 - *Recherches sur la croissance de cultures bactériennes*, Herman Paris.
5. Murray J.D., 2001 - *Mathematical Biology, I. An Introduction*, 3rd Edition, Springer-Verlag New York Berlin Heidelberg.
6. Smith H.L., Waltman P., 1995 - *The Theory of the Chemostat*, Cambridge University Press, Cambridge.

## QUALITY PARAMETERS OF APPLE FRUITS MARKETED IN IAȘI

### PARAMETRI DE CALITATE A FRUCTELOR DE MĂR COMERCIALIZATE ÎN IAȘI

*PATRAȘ Antoanela*<sup>1\*</sup>

\*Corresponding author e-mail: apatras@uaiasi.ro

**Abstract.** Apples are the most consumed fruits in Romania, all over the year. In the present work were studied fruits of 7 apple cultivars (Golden Delicious, Idared, Jonagold, Florina, Jonathan, Starkrimson, Renet) commercialized in 3 open-markets from the city of Iași at the end of April. The main analysed quality parameters were: soluble solids content, acidity, total sugars, sugar/acid ratio. Renet cultivar proved the highest total sugars and soluble solids contents, while Florina, the lowest. The most acid was Idared (Sârca) and the less acid were Starkrimson and Golden Delicious. The best values for sugar/acid ratio (over 75) were obtained by Starkrimson and Golden Delicious, and the smallest ones (less than 33) by Idared (Sârca), followed by Jonathan, Jonagold and Idared (Suceava).

**Key words:** apple fruits, storage, acidity, sugars, sugar/acid ratio

**Rezumat.** Merele sunt cele mai consumate fructe în România, pe toată perioada anului. În prezenta lucrare au fost studiate fructe provenite din 7 soiuri de măr (Golden Delicious, Idared, Jonagold, Florina, Jonathan, Starkrimson, Renet) comercializate în 3 piețe din orașul Iași la sfârșitul lunii aprilie. Principalii parametri de calitate analizați au fost: substanța uscată solubilă, aciditatea, glucidele totale, raportul zaharuri/aciditate. Cel mai mare conținut de glucide totale și substanță uscată solubilă l-a avut soiul Renet, iar cel mai mic, soiul Florina. Soiul cu cea mai mare aciditate a fost: Idared (Sârca), iar cu cea mai mică: Starkrimson și Golden Delicious. Cele mai bune valori pentru raportul zaharuri/aciditate (peste 75) au fost obținute de Starkrimson and Golden Delicious, iar cele mai mici (sub 33) de Idared (Sârca), urmat de Jonathan, Jonagold și Idared (Suceava).

**Cuvinte cheie:** mere, păstrare, aciditate, glucide, raportul zaharuri/aciditate

## INTRODUCTION

Apples are the most popular fruits all over the world, originating from more than 7500 cultivars from different countries and continents. According to the Food and Agriculture Organization Corporate Statistical Database (FAOSTAT), the world production of apples was 89.3 million tonnes in 2016, of which 467,259 tonnes produced in Romania.

The important place of apples in the hierarchy of consumers' preference is due to their pleasant taste and to the content in nutrients and bioactive

---

<sup>1</sup>University of Agricultural Sciences and Veterinary Medicine of Iasi, Romania

compounds. Their complex composition includes both organic (sugars, carboxylic acids, vitamins, polyphenols, enzymes, phytohormones) and inorganic compounds (containing the elements: N, P, S, and metals Na, K, Fe, Ca, Mg, Zn, Cu). From the organic compounds, very well represented are sugars from all subclasses: monosaccharides – glucose and fructose, oligosaccharides – sucrose, polysaccharides – starch and non-starch (known as fibres) - cellulose, pectic substances. Malic acid is the predominant carboxylic acid (Câmpeanu *et al.*, 2009). From vitamins, the main is vitamin C (ascorbic acid), but apples also contain vitamins A, B1, B2, PP. Phenolic compounds are mainly represented by tannins and flavonoids and they contribute to the fruits' taste, together with sugars, organic acids and some other aroma compounds as 1-butanol-2-methyl-acetate, 2-hexenal and 1-hexanol (Liu *et al.*, 2016; Petkovšek *et al.*, 2009). Very important is also the ratio sugar/acid, whose augmentation increases consumer's acceptance.

The content in different compounds is determined by apple cultivar, pedoclimatic conditions, horticultural practices, harvest period, conditions and duration of storage (Grădinariu and Istrate, 2003). In the case of apples commercialized during late-spring, after more than 6 months of storage, the conditions of preservation and the eventually post-harvest treatments are crucial for the fruits' quality. Usually, when buying, people are choosing apples after their appearance, but it is important the good aspect to correspond to a good taste and aroma and more than that, to an adequate content in nutritious and health-promoting compounds. In the present work were studied some chemical parameters of apple fruits from 7 cultivars commercialized in 3 open-markets from the city of Iași, during the spring season.

## MATERIAL AND METHOD

There were studied fruits of 7 apple cultivars (Golden Delicious, Idared, Jonagold, Florina, Jonathan, Starkrimson, Renet) commercialized at end of April in 3 open-markets from the city of Iași (Nicolina, Alexandru cel Bun, Independența). In the case of Idared cultivar, two samples grown in different locations were analysed: Idared originated from Sârca and Idared from Suceava. After acquisition, all apples were refrigerated at 4 °C and analysed within 2 weeks.

The analysed quality parameters were: soluble solids content (SSC), titratable acidity (TA), pH, total sugars (TS), sugar/acid ratio (S/A).

Soluble solids content was measured at 20 °C with a Zeiss refractometer. Fresh juice obtained from studied apples was used. Results were expressed as °Bx.

Titratable acidity was determined according to Savu *et al.* (2000) and results were expressed as g malic acid/100 g fresh weight (FW).

The pH was measured in fresh juice obtained from studied apples with 315i (WTW) pH-meter.

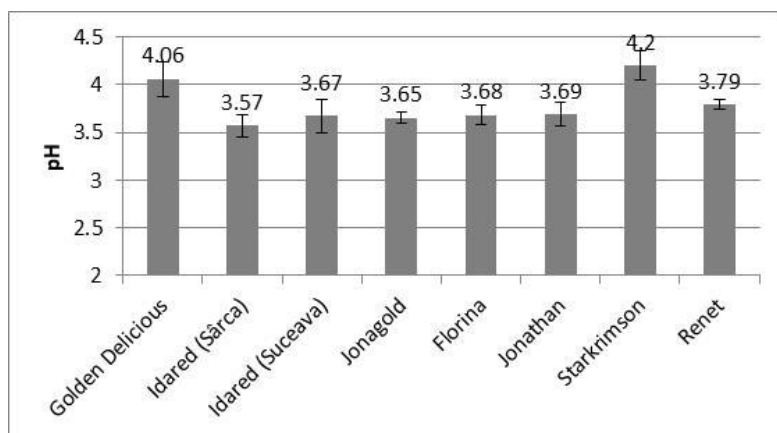
Total sugars were determined according to Savu *et al.* (2000) and results were expressed as g/100 g FW.

Sugar/acid ratio was calculated as the content of total sugars divided by titratable acidity.

All analyses were performed in triplicate and the presented values represent means±SD.

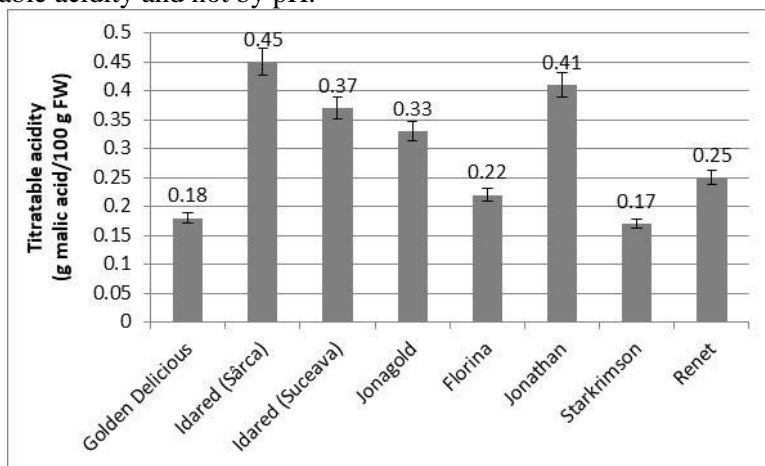
## RESULTS AND DISCUSSIONS

The studied apple samples had the pH in the regular interval, as usually, in apple juices it ranges between 3.0 and up to 4.5. In our case, the obtained pH was more acid for Idared (Sârca and Suceava), Jonagold, Florina, Jonathan and Renet (between 3.57 and 3.79) and less acid for Golden Delicious (4.06) and Starkrimson (4.20) (fig. 1).



**Fig. 1** pH values corresponding to studied apple cultivars

The obtained titratable acidity (fig. 2) was generally well correlated to the pH. Thus, the smallest TA (0.17 g malic acid/100 g FW) was obtained for Starkrimson and corresponds to the highest pH (4.20) and the most important TA (0.45 g malic acid/100 g FW) was for Idared (Sârca) (pH=3.57). The differences between TA and pH are due to the ionization of the organic acids, which are weak acids and are not completely ionized, so total acid content can be better estimated by titratable acidity and not by pH.



**Fig. 2** Titratable acidity of studied apple fruits



The small values of acidity are explained by its gradually decrease during apples' storage, confirmed by other studies. Thus, according to Radu (2012), all studied apple varieties lose acidity during storage, e.g. in Starkrimson the acidity loss was 52% after 6 months of refrigeration. Starkrimson cultivar is characterized by a low acidity even at harvest (0.38 g malic acid/100 g FW), decreasing till April to 0.18 g malic acid/100 g (Radu, 2012). At the beginning of May we obtained 0.17 g malic acid/100 g FW.

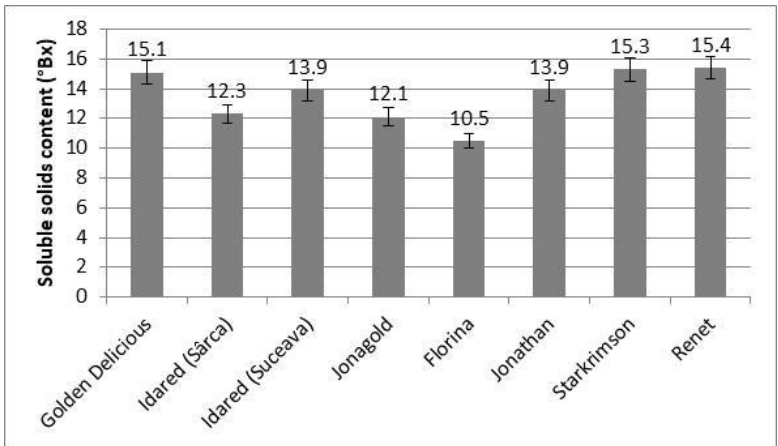


Fig. 3 Soluble solids content of studied apple fruits

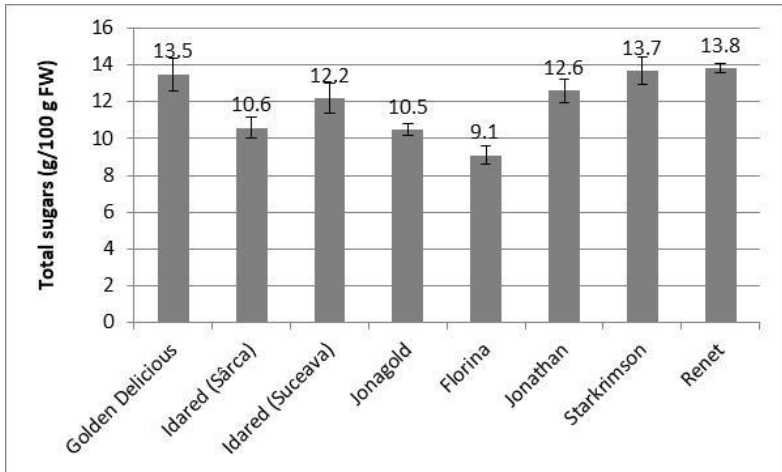
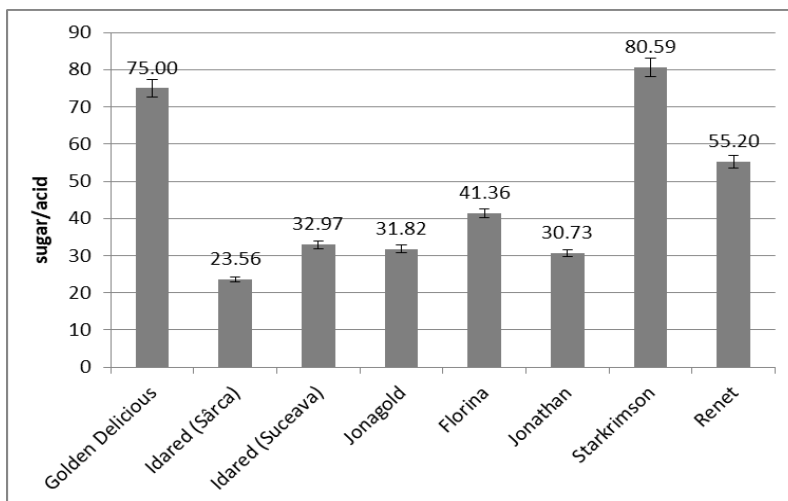


Fig. 4 Total sugars of studied apple fruits

Soluble solids content is a good indicator of sugar content of apples, as it is the major soluble solid in fruits (Nour *et al.*, 2010). Other soluble materials include organic and amino acids, soluble pectins, etc. Soluble solids were between

10.5 °Bx (Florina) and 15.4 °Bx (Renet) (fig. 3). Total sugars had the smallest content also in Florina cultivar (fig. 4). The most important total sugars contents were obtained for Golden Delicious, Starkrimson and Renet.



**Fig. 5** Sugar/acid ratio of studied apple fruits

From all chemical quality parameters, the sugar/acid ratio (S/A) is known as the best indicator for consumer's preference, as it plays an important role in flavour perception. A higher value of sugar/acid ratio generally increases consumer's acceptability. In our case, S/A increases in the order: Idared (Sârca) < Jonathan < Jonagold < Idared (Suceava) < Florina < Renet < Golden Delicious < Starkrimson. These results were confirmed by the organoleptic analyse, as Renet, Golden Delicious and Starkrimson were the top 3 preferred by the tasting team (data not shown). But must be bear in mind that the apple fruits were purchased from open-markets and were stored more than 6 months in conditions that were not the same for all samples.

## CONCLUSIONS

Renet cultivar proved the highest total sugars and soluble solids contents, while Florina, the lowest.

The most acid apple was Idared (Sârca) and the less acid were Starkrimson and Golden Delicious.

The best values for sugar/acid ratio (over 75) were obtained by Starkrimson and Golden Delicious, and the smallest ones (less than 33) for Idared (Sârca), followed by Jonathan, Jonagold and Idared (Suceava).

*Acknowledgments: AUF ECO - project S0446 SAIN.*

REFERENCES

1. Câmpeanu G., Neata G., Darjanschi G., 2009 - *Chemical composition of the fruits of several apple cultivars growth as biological crop*. Notulae Botanicae Horti Agrobotanici Cluj-Napoca, 37(2), p. 161-164.
2. Grădinariu G., Istrate M., 2003 - *Pomicultura generală și specială*, Editura Tipo Moldova, Iasi, ISBN 973-8422-47-7, p. 528
3. Liu Y., Chen N., Ma Z., Che F., Mao J., Chen B., 2016 - *The changes in color, soluble sugars, organic acids, anthocyanins and aroma components in "Starkrimson" during the ripening period in China*. Molecules, 21(6), p. 812-824.
4. Nour V., Trandafir I., Ionica M. E., 2010 - *Compositional characteristics of fruits of several apple (Malus domestica Borkh.) cultivars*. Notulae Botanicae Horti Agrobotanici Cluj-Napoca, 38(3), p. 228-233.
5. Petkovšek M. M., Štampar F., Veberič R., 2009 - *Changes in the inner quality parameters of apple fruit from technological to edible maturity*. Acta Agriculturae Slovenica, 93, p. 17-29.
6. Radu Roxana Mihaela, 2012 - *Cercetări privind unele tehnologii alternative de tratament postrecoltă la fructele de măr*. Teză de doctorat, USAMV Iași, p. 70
7. Savu Maria, Afusoe Iulia, Nechita Patraș Antoanela, Trofin Alina Elena, Marcu I., 2000 - *Biochimie vegetală, lucrări practice*, USAMV. Iași, p 54-59, 119-120, 138-142
8. \*\*\* FAOSTAT. <http://www.fao.org/faostat/en/#data/QC/>, Retrieved 2018-08-13. Countries - Select All; Regions - World + (Total); Elements - Production Quantity; Items - Apples; Years - 2016

**RESEARCH ON THE ECONOMIC EFFICIENCY OF THE  
AGRICULTURAL ECOSYSTEM UNDER  
AGRO-TECHNICAL MEASURES TO CROPS OF CORN**

**CERCETĂRI PRIVIND EFICIENȚA ENERGETICĂ A ECOSISTEMULUI  
AGRICOL SUB INFLUENȚA MĂSURILOR AGROTEHNICE LA  
CULTURA DE PORUMB**

*BACĂU Cristina*<sup>1\*</sup>, *GÎDEA Mihai*<sup>2</sup>, *MIHALASCU Costel*<sup>2</sup>

\*Corresponding author e-mail: ccurec@gmail.com

***Abstract.** Against the background of global warming, increasing pollution levels and requirements for limiting the use of fossil fuels, demand for biomass has increased. For testing the energy efficiency of the agro ecosystem in the Experimental Farm of the Moara Domneasca, Găneasa, Ilfov County, a bi factorial experience has been achieved in which Factor A = Nitrogen Fertilization Level (N) and Factor B = Irrigation Level. Increasing the level of nitrogen fertilization (N) on the same phosphorus soil conditions has led to statistical gains of both the main production of grain production, thus maintaining land use for agricultural production, as well as secondary production that has potential for use as bio fuel. The increase in the level of irrigation ( $a_2$ ,  $a_3$ ) led to a very significant increase of the grain yields (kg / ha) and of the biomass production. Analyzing the economic efficiency of the ecosystem under the influence of the technological measures, it is noted the significant increase of all economic indicators compared to unfertilized ( $b_1$ ) or non-irrigated ( $a_1$ ) control, increases are proportional to the applied nitrogen dose and watering standard.*

**Key words:** biomass, bio fuel, increase yields, irrigation, fertilization.

***Rezumat.** În ultima perioadă, pe fondul încălzirii globale și a creșterii nivelului de poluare și a cerințelor privind limitarea utilizării combustibililor fosili, s-a intensificat cererea de biomasă. Cercetările s-au desfășurat în condițiile preluvosolului din Câmpia Română, în Ferma Experimentală Moara Domneasca, Găneasa, jud. Ilfov. Pentru testarea eficienței energetice a ecosistemului, s-a realizat o experiență bifactorială, în care Factor A Nivelul de fertilizare cu azot cu 3 graduări și Factor B nivelul de irigare cu 3 graduări. În urma cercetarilor s-a constatat că creșterea nivelului de fertilizare cu azot pe același agrofond de fosfor a adeterminat creșteri asigurate statistic atât ale producției principale, producția de boabe (kg / ha), menținându-se astfel destinația terenului pentru producția agricolă, dar și producția secundară care are potențial de utilizare ca biocombustibil. Creșterea nivelului de irigare ( $a_2$ ,  $a_3$ ) a determinat creșterea foarte semnificativă a producțiilor de boabe dar și a producției de biomasă. Din punct de vedere al eficienței energetice a ecosistemului, sub influența măsurilor tehnologice, se constată o creștere semnificativă a cantității de energie produsă comparativ cu matorul nefertilizat ( $b_1$ ) sau neirigat ( $a_1$ ). Cantitatea de energie produsă este proporțională cu doza de azot aplicată și cu norma de udare aplicată.*

**Cuvinte cheie:** biomasă, biocombustibil, creșterea producției, irigații, fertilizare.

<sup>1</sup>University of Agricultural Sciences and Veterinary Medicine of Banat "Regele Mihai I al României", Timisoara, Romania

<sup>2</sup>University of Agronomic Sciences and Veterinary Medicine of Bucharest, Romania

## INTRODUCTION

With a cultivated area of about 200 million hectares, maize occupies the second position in the world in terms of cultivated areas after wheat culture (FAOSTAT).

Worldwide, the corn crop productions are on the rise as a result of increased technological performance. In Romania, the areas cultivated with maize recorded a descending trend from 3.11 million hectares in 1995 to 2.41 million hectares in 2017. The level of average harvested production shows an upward trend from 2.76 t/ha in 1990, reaching a production of 5.96 t/ha in 2017, with very high production fluctuations, ie 1.71 t/ha in 2000 or 3.47 t/ha in 2015.

As the cultivated areas remain relatively constant, and at the level of the agricultural holdings there is a certain balance, with no significant variations in the structure of the crops, these modifications can be explained as a result of the climatic conditions and especially of the level precipitation.

Applying of the irrigation management allows to reduce the amount of water used and to obtain high yields under drought conditions (Kranz *et al.*, 2018).

The moment of application of the watering doses and their size have a direct impact on the productivity indicators of corn grain number, grain filling (Nilahyane *et al.*, 2018).

In the pedoclimatic conditions in Transylvania Plain, it has been demonstrated that the application of watering doses must be correlated with the amount of precipitation and in a year with rainfall excess watering doses can be reduced to more than half (Pandrea, 2012).

The purpose of the research was to evaluate the impact of irrigation and fertilization on the economic efficiency of maize crops in pedoclimatic conditions at the Moara Domneasca, Ganeasa, Ilfov County.

## MATERIAL AND METHOD

In order to achieve the established objective, in the agricultural year 2016-2017 a bifactorial experience was realized where:

Factor A = Watering doses with 3 graduations:  $a_1$  = no irrigation,  $a_2$  = 50% dose standard,  $a_3$  = 100% watering dose.

Factor B = Nitrogen fertilization level where:  $b_1$ = unfertilized nitrogen,  $b_2$ = 75 kg N / ha,  $b_3$ = 150 kg N/ha.

Experience was realized by parcel method subdivided into 4 rehearsals.

Nitrogen doses were provided by the use of urea. The irrigation water used came from a drilled well.

For the calculation of the watering doses, the following formula was used:

$$\sum m = ETRO - Pv - Af - (Ri - Rf) (m^3/ha)$$

where:

- $\sum m$  - is the annual irrigation requirement (irrigation standard) or monthly irrigation water ( $m^3$  / ha);

-ETRO - optimal actual evapotranspiration or total water consumption in the growing season or in the month of calculation, or since the last watering ( $m^3 / ha$ );

-Pv - the amount of useful rainfall during the vegetation period or the calculation month with the insurance of 80% ( $m^3 / ha$ );

-Af - water intake from groundwater in the case of open circuit balance ( $m^3/ha$ );

-Ri - soil water reserve at crop sowing or at the beginning of the calculation month ( $m^3/ha$ );

-Rf - Soil water reserve at crop harvest or at the end of the calculation month ( $m^3/ha$ ).

Density of the crop to land was 60,000 plants/ha.

Income = production (kg/ha) x sales price (lei/kg)

Profit = Income (lei/kg) - Expenses (lei/kg)

Profit rate = (profit/expense) x 100

## RESULTS AND DISCUSSIONS

The obtained production results are centralized in table 1. Data analysis shows that the application of the watering and nitrogen fertilization norms had an impact on the harvested grain maize (kg/ha) production.

### *Influence of nitrogen fertilization on the obtained productions (B).*

Analyzing the influence of the application of fertilization on the harvested grain maize production, it is observed that the increase of the nitrogen doses revealed the increase of the yields obtained from 3246 kg/ha in the unfertilized variant up to 6403 kg/ha in the fertilization with 150 kg N/ha, the production gains are very significant (tab. 1).

Table 1

**Production of grain corn (kg / ha) obtained under the influence of nitrogen fertilization and irrigation**

Specifications	a <sub>1</sub> (without irrigation)	a <sub>2</sub> (50% dose)	a <sub>3</sub> (100% dose)	average b
<b>b<sub>1</sub> (unfertilized)</b>	2300	3230	3980	3170.0
<b>b<sub>2</sub> (75 kg/ha N)</b>	3120	4480	5160	4253.3
<b>b<sub>3</sub> (150 kg/ha N)</b>	4910	6510	6960	6126.7
<b>average a</b>	3443.3	4740.0	5366.7	
	A	B	A x B	B x A
LSD 5%	194.39	295.89	314.54	375.52
LSD 1%	284.4	404.4	519.47	552.35
LSD 0,1%	411.7	625.34	697.12	720.79

### *Influence of application of watering doses on obtained yield (A).*

As a result of the application of the watering norms, an increase in the production of grain maize (kg/ha) from 3443 kg/ha in the variant without irrigation (a<sub>1</sub>) to 5366 kg / ha was observed in the case where each watering was applied 100% (a<sub>3</sub>), with production increases being very significant (tab. 1).

***Influence of applying watering doses for the same level of fertilization (AxB).***

It is found that for all levels of fertilization ( $b_2$ ,  $b_3$ ) the application of the watering doses ( $a_2$ ,  $a_3$ ) determined the increase of the obtained productions and in all the variants studied the application of watering resulted in very significant production gains.

***Influence of nitrogen fertilization (N) on the same watering standard (BxA).***

From the analysis of the data centralized in table 1 we can see that the fertilization with nitrogen (N) has determined the increase of the obtained products for all studied fertilization variants ( $b_2$ ,  $b_3$ ), and the production gains obtained are very significant.

The results of the expenditure on corn crops under the influence of nitrogen fertilization (N) and irrigation doses are centralized in table 2. Analyzing the data, it is found that the level of expenditures varied between 1480 lei/ha in the non-fertilized nitrogen control variant ( $b_1$ ) and non-irrigated ( $a_1$ ) and 2714 lei/ha in the variant where 150 kg N/ha ( $b_3$ ) and a 100% watering standard ( $a_3$ ) were applied. The expenditures that were recorded included two components: a constant component, represented by the sum of the expenditures with the soil works, the foundation and the maintenance of the crop and harvesting; the second component is the sum of variable costs with fertilization and the application of watering doses. According to the technological file, the fertilization costs of 75 kg N/ha were 261 lei/ha and the one with 150 kg N/ha of 521 lei/ha. The total irrigation costs were 380 lei/ha when applying 100% of the calculated norm, or 190 lei when 50% of the required amount was applied.

Table 2

**Expenses (lei/ha) recorded for maize crop under the influence of nitrogen fertilization and irrigation**

Specifications	$a_1$ (without irrigation)	$a_2$ (50% dose)	$a_3$ (100% dose)	average b
$b_1$ (unfertilized)	1480	1940	2350	1923.3
$b_2$ (75 kg/ha N)	1712	2122	2532	2122.0
$b_3$ (150 kg/ha N)	1894	2304	2714	2304.0
<b>average a</b>	1695.3	2122.0	2532.0	
	A	B	A x B	B x A
LSD 5%	97.05	108.62	144.95	127.57
LSD 1%	139.11	171.98	207.76	189.03
LSD 0,1%	196.12	245.48	305.7	244.84

***The influence of Nitrogen Fertilization on Expenditures (B).***

Analyzing the influence of the application of fertilization on the expenditures it is observed that the increase of the applied nitrogen doses caused

the increase of the expenditures from 1480 lei/ha to the unfertilized variants ( $b_1$ ) to 2304 lei/ha in the fertilized variants with 150 kg N/ha ( $b_3$ ) (tab. 2).

***Influence of application of watering doses on produced products (A).*** Following the application of the watering norms, an increase in production costs was recorded from 1695 lei/ha in the case of the control variant ( $a_1$ ) up to a value of 2532 lei/ha in the variant where 100% of the required watering standard was applied ( $a_3$ ), these increases in expenditure being very significant.

***Influence of applying watering doses for the same level of fertilization (AxB)***

Applying the watering doses ( $a_2$ ,  $a_3$ ) for the same nitrogen fertilization dose has in all cases led to a significant increase in expenditure (tab. 2).

***Influence of nitrogen fertilization on the same watering standard (BxA).***

From the analysis of the data centralized in table 2, it is noticeable that nitrogen fertilization (B) led to an increase in expenditure for all studied irrigation levels (A), and expenditure increases are very significant (tab. 2).

The results of the incomes (lei/ha) obtained from the corn crop under the influence of nitrogen fertilization (B) and the irrigation doses are centralized in table 3. It can be seen that the incomes varied between 1403 lei/ha in the control variant ( $a_1$ ,  $b_1$ ) and a maximum value of 4245 lei/ha in the variant where 150 kg N/ha and 100% of the watering standard ( $a_3$ ,  $b_3$ ) were applied.

***Influence of application of watering doses on income obtained (A).*** Following the application of the watering norms, there is an increase in the incomes obtained from 2100 lei/ha to 3273 lei/ha in the variants where a 100% watering norm was applied, the registered income increases being very significant (tab. 3).

Table 3

**Income (lei/ha) recorded in maize crop under the influence of nitrogen fertilization and irrigation**

Specifications	$a_1$ (without irrigation)	$a_2$ (50% dose)	$a_3$ (100% dose)	average b
$b_1$ (unfertilized)	1403	1970.3	2427.8	1933.70
$b_2$ (75 kg/ha N)	1903.2	2732.8	3147.6	2594.53
$b_3$ (150 kg/ha N)	2995.1	3971.1	4245.6	3737.27
average a	2100.43	2891.40	3273.67	
	A	B	A x B	B x A
LSD 5%	106.07	146.02	165.32	188.73
LSD 1%	169.72	233.63	264.51	301.97
LSD 0,1%	233.36	321.23	363.7	415.21

***Influence of nitrogen fertilization (B) on the obtained production.***

The increase in the level of nitrogen fertilization (B) caused an increase of the obtained incomes (lei/ha) from 1933 lei/ha to 3737 lei/ha in variants where 150 kg nitrogen/ha ( $b_3$ ) was applied (tab. 3).



***Influence of applying watering doses for the same level of fertilization (AxB)***

It is found that for all tested levels of fertilization ( $b_2$ ,  $b_3$ ), the application of the watering doses ( $a_2$ ,  $a_3$ ) determined the increase of the obtained revenues, and the income increases are very significant in all cases.

***Influence of nitrogen fertilization on the same watering dose (BxA)***

The application of nitrogen doses (B) led to an increase in the income obtained for all studied irrigation variants (A), and the recorded income increases are very significant (tab. 3).

Table 4 summarizes earnings data. It is noted that the profits varied depending on the applied rates between 83 lei/ha and 1983 lei/ha.

***Influence of application of watering doses (A) on profits obtained.***

It is noticed that the increase of the applied watering norms has led to the increase of the profits obtained from 506 lei / ha for the irrigation ( $a_1$ ) variants up to 1299 lei/ha for the variants to which a full watering standard ( $a_3$ ) are very significant (tab. 4).

Table 4

**The profit (lei/ha) obtained in the corn crop under the influence of nitrogen fertilization and irrigation**

Specifications	$a_1$ (without irrigation)	$a_2$ (50% dose)	$a_3$ (100% dose)	average b
$b_1$ (unfertilized)	83	460.3	727.8	423.70
$b_2$ (75 kg/ha N)	322.2	961.8	1186.6	823.53***
$b_3$ (150 kg/ha N)	1113.1	1899.1	1983.6	1665.27***
average a	506.10	1107.07***	1299.33***	
	A	B	A x B	B x A
LSD 5%	61.6	58.4	71.3	68.6
LSD 1%	99.8	88.6	109.5	108.4
LSD 0,1%	137	140.7	152.8	155.7

***Influence of nitrogen fertilization (B) on profits obtained***

The increase of the nitrogen fertilization level resulted in an increase of the profits obtained from 423 lei/ha to 1665 lei/ha in the variants where 150 kg nitrogen/ha ( $b_3$ ) were applied.

***Influence of applying watering doses for the same level of fertilization (AxB)***

It is found that for all tested levels of fertilization ( $b_1$ ,  $b_2$ ), the application of the watering doses ( $a_2$ ,  $a_3$ ) has led to a very significant increase in the profits obtained.

***Influence of nitrogen fertilization on the same watering standard (B xA)***

The application of nitrogen doses ( $b_2$ ,  $b_3$ ) led to a very significant increase in the profits obtained for all studied irrigation variants ( $a_2$ ,  $a_3$ ) (tab. 4).

Table 5 summarizes earnings data.

***Influence of application of the watering doses on the profits obtained (A).***

It is noticeable that the increase in the applied watering doses has led to an increase in the profit rate from 28.6% for non-irrigated variants to 63.67% for variants where a 100% watering standard has been applied.

Table 5

**Profit rate (%) obtained in corn crop under the influence of nitrogen fertilization and irrigation**

Specifications	a <sub>1</sub> (without irrigation)	a <sub>2</sub> (50% dose)	a <sub>3</sub> (100% dose)	average b
b <sub>1</sub> (unfertilized)	6.3	30.5 <sup>***</sup>	42.8 <sup>***</sup>	26.53
b <sub>2</sub> (75 kg/ha N)	20.4 <sup>***</sup>	54.3 <sup>***</sup>	60.5 <sup>***</sup>	45.07 <sup>***</sup>
b <sub>3</sub> (150 kg/ha N)	59.1 <sup>***</sup>	91.7 <sup>***</sup>	87.7 <sup>***</sup>	79.50 <sup>***</sup>
average a	28.60	58.83 <sup>***</sup>	63.67 <sup>***</sup>	
	A	B	A x B	B x A
LSD 5%	2.5	3.1	3.5	3.3
LSD 1%	4.1	4.7	5.4	5.2
LSD 0,1%	5.7	7.5	7.5	7.4

***Influence of Nitrogen Fertilization on Profit Rate (B).***

The increase in nitrogen fertilization has led to a very significant increase in profits from 26.5% to 79.5% in variants where 150 kg nitrogen/ha (b<sub>3</sub>) was applied.

***Influence of applying watering doses to the profit rate for the same level of fertilization (AxB).***

It is noted that the application of nitrogen doses resulted in very significant increases in the profits obtained for all tested fertilization levels (table 5).

***Influence of nitrogen fertilization on the profit rate under the same watering standard (BxA).***

Applying nitrogen doses led to a very significant increase in the profits obtained for all studied irrigation variants (a<sub>2</sub>, a<sub>3</sub>) (tab. 5).

## CONCLUSIONS

1. Applying nitrogen doses has led to increased production and economic indicators.

2. Irrigation had a favorable impact on the yields of grain maize (kg/ha) as well as on other economic indicators.

3. Simultaneous application of nitrogen doses (b<sub>2</sub>, b<sub>3</sub>) and watering doses (a<sub>2</sub>, a<sub>3</sub>) had a synergistic effect, leading in all cases to increases in the yields obtained.

4. The profit rate recorded the highest values when applying a nitrogen norm of 150 kg/ha (b<sub>3</sub>) supplemented with 50% of the water requirement (a<sub>2</sub>).

## REFERENCES

1. **Gîdea M., Ciontu C., Sandoiu D.I., Penescu A., Schiopu T., Nichita Mihaela, 2015** - *The Role of Rotation and Nitrogen Fertilization Level upon the Economic Indicators at Wheat and Corn Crops in Condition of a Long Term Experience*. Agriculture and Agricultural Science Procedia, vol. 6, pp:24-29.
2. **Jitoreanu G., Ailincăi C., Bucur D., 2006** - *Influence of tillage systems on soil physical and chemical characteristics and yield in soybean and maize grown in the Moldavian Plain (North – Eastern Romania)*. Advances in Geoecology, 38, CATENA Verlag, Reiskirchen, Germany, Vol. 1, pp. 370-379.
3. **Kranz L.W., S.J. van Donk, Martin D.L., 2008** - *Irrigation Management for Corn*. NebGuide [https://www.researchgate.net/publication/240623155\\_Irrigation\\_Management\\_for\\_Corn](https://www.researchgate.net/publication/240623155_Irrigation_Management_for_Corn).
4. **Lana Maria do Carmo, Czycza R.V., Rosset J.S., Frandoloso J.F., 2013** - *Maize nitrogen fertilization in two crop rotation systems under no-till*. Rev. Ceres, vol. 60 (6), pp. 852-862.
5. **Liu M., Yu Z., Liu Y., Konijn N.T., 2006** - *Fertilizer requirements for wheat and maize in China: the QUEFTS approach*. Nutrient Cycling in Agroecosystems, 74: 245 –258
6. **Marin D.I., Mihalache M., Ciontu C., Bolohan C., Ilie L., 2011** - *Influence of soil tillage of pea, wheat and maize crop in the Moara Domneasca-Ilfov area*. 5<sup>th</sup> International Symposium - Soil Minimum Tillage System, Risoprint, Cluj-Napoca, Vol. 1, pp. 111-118.
7. **Moraru Paula, Rusu T., 2012** - *Effect of tillage systems on soil moisture, soil temperature, soil respiration and production of wheat, maize and soybean crops*. Journal of Food, Agriculture and Environment, 10. 445-448.
8. **Nilahyane A., Islam M.A., Mesbah A.O., Garcia y Garcia A., 2018** - *Effect of Irrigation and Nitrogen Fertilization Strategies on Silage Corn Grown in Semi-Arid Conditions*. Agronomy, vol. 8(10), <https://www.mdpi.com/2073-4395/8/10/208>
9. **Pandrea R.C., 2012** - *Cercetări privind influența tehnologiei și a regimului de irigare asupra producției de boabe la cultura de porumb în Câmpia Transilvaniei*. Teza doctorat, <http://www.usamvcluj.ro/files/teze/2012/pandrea.pdf>
10. **Smaling E.M.A., Janssen B.H., 1993** - *Calibration of QUE-FTS, a model predicting nutrient uptake and yields from chemical soil fertility indices*. Geoderma, 59: 21 –44.
11. **Toader C., Mărghitaș Marilena, Mihai Mihaela, Șandor M., 2011** - *Effect of differentiated fertilization systems on maize crop on nutrient production and accumulation in the soil and grains*. Research Journal of Agricultural Science, 43 (1), pp: 195-198
12. **Trif Alexandra, Gîdea M, Boască A., Cîmpeanu S.M., 2017** - *Research into the potential of utilizing image processing for the evaluation of maize culture*. Scientific Papers. Series E. Land Reclamation, Earth Observation Surveying, Environmental Engineering, Vol. VI, pp:189-192
13. **Țiu Jeni Veronica, Teodorescu R.I, Mihalache M., Tudor Valerica, Asănică A., Cîmpeanu S.M., 2016** - *The Effect of Drip Irrigation on Several Physical and Chemical Features of Soil*. Romanian Biotechnological Letters, Vol. 21, No. 4, pp: 11737-11745
14. <http://www.fao.org/faostat/en/#data/QC>

## RELATIONSHIP BETWEEN URBANISM AND LANDSCAPING

### RELAȚIA DINTRE URBANISM ȘI PEISAGISTICĂ

*DASCĂLU Doina Mira*<sup>1</sup>, *COJOCARIU Mirela*<sup>1\*</sup>,  
*GRECU Codrina*<sup>1</sup>, *PAȘCU Roxana*<sup>1</sup>

\*Corresponding author e-mail: mirelacojocariu@yahoo.com

**Abstract.** *From the simplest forms of habitation organization to the most complex human settlements, it can be seen how nature was or was not integrated into urban space. A human settlement cannot be reduced to a simple accumulation of construction. The outer space or the space between constructions has specific functions and is governed by specific laws. The importance of this space in the complex structure of human settlements can be highlighted by reviewing the history of urbanism. In this process of evolution of the spatial component, an important role is played by the passageways or the urban transition areas. These areas are those where green spaces and/or landscaped zones are gradually emerging, increasingly performing more and more important functions. Why in this early age of the new millennium landscaping process has become an extremely effective tool of the urban science? Because in the context of accelerated pollution and degradation of the Earth, the urban regeneration is possible by interfering the urban and landscaping means of action, through functional solutions stemming from the real needs of the environment and inhabitants.*

**Key words:** urbanism, landscaping, space, functions

**Rezumat.** *De la cele mai simple forme de organizare ale locuirii și până la cele mai complexe așezări umane, poate fi observat modul în care natura a fost sau nu integrată în spațiul urban. O așezare umană nu poate fi redusă la un simplu cumul de construcții. Spațiul exterior, sau spațiul dintre construcții, are funcții specifice și este guvernat de legi specifice. Importanța acestui spațiu în structurarea complexă a așezărilor umane poate fi evidențiată prin trecerea în revistă a istoriei urbanismului. În acest proces de evoluție al componentei spațiale, un rol important îl joacă spațiile de trecere sau zonele urbane de tranziție. Aceste zone sunt cele în care apar treptat spațiile verzi și amenajările peisagere, îndeplinind de-a lungul timpului funcții din ce în ce mai importante. De ce în această epocă de început de mileniu peisagistica a devenit un instrument extrem de eficient al științei urbanismului? Deoarece în contextul poluării și degradării accelerate a Terrei, regenerarea mediului urban este posibilă prin interferarea mijloacelor de acțiune urbanistice și peisagistice, prin rezolvările funcționale izvorâte din nevoile reale ale mediului și ale locuitorilor.*

**Cuvinte cheie:** urbanism, peisagistică, spațiu, funcțiuni.

---

<sup>1</sup>University of Agricultural Sciences and Veterinary Medicine Iasi, Romania

## INTRODUCTION

In the historical context, the various manners of organizing the human settlements were initially accompanied by the gesture of isolation from the environment through defensive arrangements. From the simplest forms of organization to the most complex human settlements, we can see how nature has or hasn't been integrated into the urban space (Toynbee, 1979). Initially, in the pre-urban times, the first earth-waves and ditches were created as a defense against attacks by animals and protection against extreme natural phenomena. Subsequently, the ramparts and fortifications was based on the need to defend against human attacks. The gesture of isolation from nature is a reaction that follows humankind throughout its history. Urban evolution has often manifested itself, in space and time, by the "apparent" exclusion of nature from the space of the built city. But this "appearance" still hides an "urban permeability" that could be defined as absorption of natural elements by the cores of traditional settlements (Krier, 2006). Thus, despite the efforts of the cities towards detachment and control, nature has always been more or less visible in urban structures and tissues.

## MATERIAL AND METHOD

A human settlement can not be reduced to a simple cumulation of constructions. The outer space or space between constructions has specific functions and is governed by specific laws (Gheorghiu T. O., 2009). The importance of this space in the complex structure of human settlements can be highlighted by reviewing the history of their evolution. The emergence of the spatial component requires the study of the historical ratio between built-up urban volume and the unconstructed volume—usually the space between buildings. This report has put a characteristic mark on the personality of the settlements; throughout history, we notice that it is becoming more and more complex. By reviewing its various degrees of complexity, the gradual urban evolution from the individual level of the constructions to that of the assembled constructions, through the involvement of the spatial component, is highlighted.

In this process of evolution of the spatial component, an important role is played by the passageways or the urban areas of transition, areas in which the green spaces and landscaping will gradually appear later on. By their presence in urban tissues, green areas can play an important role, clarifying sometimes urban functional zoning. This paper analyzes how landscaping performs very important urban functions, thus highlighting the complexity of its relationship with urbanism science.

## RESULTS AND DISCUSSIONS

Observing and analyzing the evolution of human settlements, we understand more clearly the relationship between urbanism and landscaping, as well as its importance.

1. The maintenance of the inner-spatial organization of cities would be the first level. This level shows that over time there have been settlements that have included nature in their structures (such as the medieval eastern cities). In the

modern period of the nineteenth century and in the interwar period of the twentieth century, "garden towns" appeared, which, following the prescriptions of the Athens Charter (of CIAM), included nature in urban fabric - through green spaces, water and light - even if they did it in a functionalist-schematic way, pursuing more of its sanitary contribution.

2. The second level could refer to the city and site report. In the context of spontaneous development from pre-urban times, flexible adaptation is found, we could even say respectful to the natural environment of settlements to the characteristics of their locations (Gheorghiu, 2009). This denotes their wise desire for harmony with nature for the purpose of survival. The study of history reveals that this phase has been taken up by all civilizations. Today we call this attitude as sustainable. In parallel with the spontaneous development, there have also been situations of preconceived / guided developments that have often been either indifferent to the natural environment or hostile / aggressive, destroying it to make space and develop. At present, despite the collective concern of the city-nature report and the concern to preserve the quality of the environment, urban development continues to degrade and destroy the natural environment.

3. The intimate and subtle structures of the city, related to urban life and its needs, are the third level of observation. These needs dictated in time the evolution of human settlements. The fact that the two urban models - spontaneous and preconceived - coexisted in time, demonstrates that accumulation of experiences, correlation and synthesis of historical information about the city, have added to the urban ancestral memory and generated transcultural, transpatial and trans-natural urban manifestations and planning gestures (Dascălu Doina Mira, 2006). Urbanistic utopias that have characterized the various historical periods also show that urban patterns are going upward, towards the reintegration of the nature into the urban organism. Urban symbolic models remain deeply integrated in nature because they are based on ancestral "transcultural archetypes", as Carl Gustav Jung observes: "The city is substantially dependent on nature."

Most publications about cities use the generic name of "green spaces" or "planted spaces", referring to landscaped areas. Urbanism uses the generic name of green spaces, given that the city is "viewed from above" as a whole, and vegetation is the predominant element into these spaces. In urban planning science, this name must therefore be understood in its complex sense. From the urban point of view, the green spaces (landscaped or not) fulfill some important functions. Functional zoning is the one that organizes the city in terms of functions, dividing the city into areas characterized by a predominant function, or in areas that can accumulate a functional plurality from which one obviously dominates. By their presence in urban tissues, green areas play an important role,

clarifying many times urban functional zoning (Dascălu Doina Mira, 2016). In many cases of urban tissues there are vastly planted areas, which can themselves constitute areas with special functionality, both from urban and landscape perspective.

Depending on the size of the area occupied and the site, the planted and landscaped areas contribute to:

- separation between certain functional areas that disturb each other from certain points of view; here are some examples of areas between which the existence of such a "buffer" is necessary: circulation-dwelling, circulatory-educational area, road-pedestrian, housing-industry etc. ;
- unification or transition between different urban spaces - for example, a historic center can be linked to a modernly built area through a planted and judiciously landscaped area;
- delimitation of the disordered growth of urban agglomeration.

Nowadays, due to the pollution of the urban environment, the townspeople want refuge in nature as close as possible to the dwelling areas. As a result, oases of nature in the form of multifunctional landscaping, complex design, have been created in increasing numbers, satisfying the need for sustainable and healthy urban refuge and relaxation. Most of them manage to be located in unused spaces between buildings, which are those transition areas mentioned above.

## CONCLUSIONS

In conclusion, through their presence in urban tissues, green areas can play an important role, often clarifying urban functional zoning.

In the context of the accelerated pollution and degradation of the Earth, the regeneration of the environment is possible by interfering with the urban and landscape means of action, through functional solutions stemming from the real needs of the environment and people.

Urban landscaping functional areas have a positive contribution to the improvement of comfort, quality and sanity of human life, especially through the sustainable and complex multi-functionality of the environment.

## REFERENCES

1. **Dascălu Doina Mira, 2006** - *Mediul înconjurător și evoluția așezărilor umane-interferențe*, Ed. Societății Academice "Matei - Teiu Botez", Iași, p. 185-190.
2. **Dascălu Doina Mira, 2016** - *Proiectarea Peisagistică*, Ed. Ion Ionescu de la Brad, Iași, p. 23-26, 49-50.
3. **Gheorghiu T. O., 2009** - *Așezări Umane.Repere teoretice și istorie*, vol.I, Ed. ArtPres, Timișoara, p. 48-51.
4. **Krier R., 2006** - *Town Spaces*, Ed.Birkhauser, Basel, p.8-10.
4. **Toynbee A., 1979** – *Orașele în mișcare*, Ed. Politică, București, p. 260-270

## LANDSCAPE PLANNING OF URBAN GREEN SPACES - PSYCHOLOGICAL AND SOCIAL IMPACT ON THE INHABITANTS OF IASI

### AMENAJAREA SPAȚIILOR VERZI URBANE – IMPACTUL PSIHOLOGIC ȘI SOCIAL ASUPRA LOCUTORILOR DIN IAȘI

*GRECU Codrina*<sup>1\*</sup>, *COJOCARIU Mirela*<sup>1</sup>, *PURCARU A.*<sup>2</sup>

\*Corresponding author e-mail: [codrina.grecu@gmail.com](mailto:codrina.grecu@gmail.com)

**Abstract.** *It is well known in history that the rapid development of culture, civilization, technology and industry of the population from certain areas of the globe has been favored by a favorable environment, either geographically and climate or from the perspective of the absence of internal or external conflicts, by the presence on their territories of mineral or flora and fauna resources, or even their own human resource. Extrapolating the idea above, this paper seeks, at the smaller scale of a city nowadays, how the environmentally arranged landscape can beneficially influence the overall development of the urban area, but especially of its inhabitants, from the point of view of physically-psychological-sanogenic, but also socially and culturally, with examples from the city of Iasi.*

**Key words:** green areas landscaping, the impact of landscaping on the population

**Rezumat.** *Se cunoaște din istorie că, dezvoltarea rapidă a culturii, civilizației, tehnologiei și industriei populațiilor din anumite zone de pe Glob a fost favorizată de un mediu prielnic, fie din punct de vedere geografic și climatic, fie din perspectiva absenței conflictelor interne sau externe, fie prin prezența pe teritoriile lor a unor resurse minerale sau de floră și faună, sau chiar prin resursa umană proprie. Extrapolând ideea de mai sus, această lucrare urmărește, la scara mai mică a unui oraș din zilele noastre, modalitatea cum, mediul ambiant amenajat peisager poate influența în mod benefic dezvoltarea generală a zonei urbane respective, dar mai ales a locuitorilor ei, atât din punct de vedere fizico-psihologic-sanogen dar și social și cultural, cu exemplificări din orașul Iași.*

**Cuvinte cheie:** amenajare peisageră a spațiilor verzi, impactul amenajărilor peisagere asupra populației

## INTRODUCTION

Accelerated urbanization results in the progressive increase of the urban population in detriment of the countryside people and may result in limiting access to nature for city residents and even exposure to certain hazards such as air, soil, or noise pollution, floods or overheating phenomena, etc.

---

<sup>1</sup>University of Agricultural Sciences and Veterinary Medicine Iasi, Romania

<sup>2</sup>“Gheorghe Asachi” Technical University of Iasi, Romania

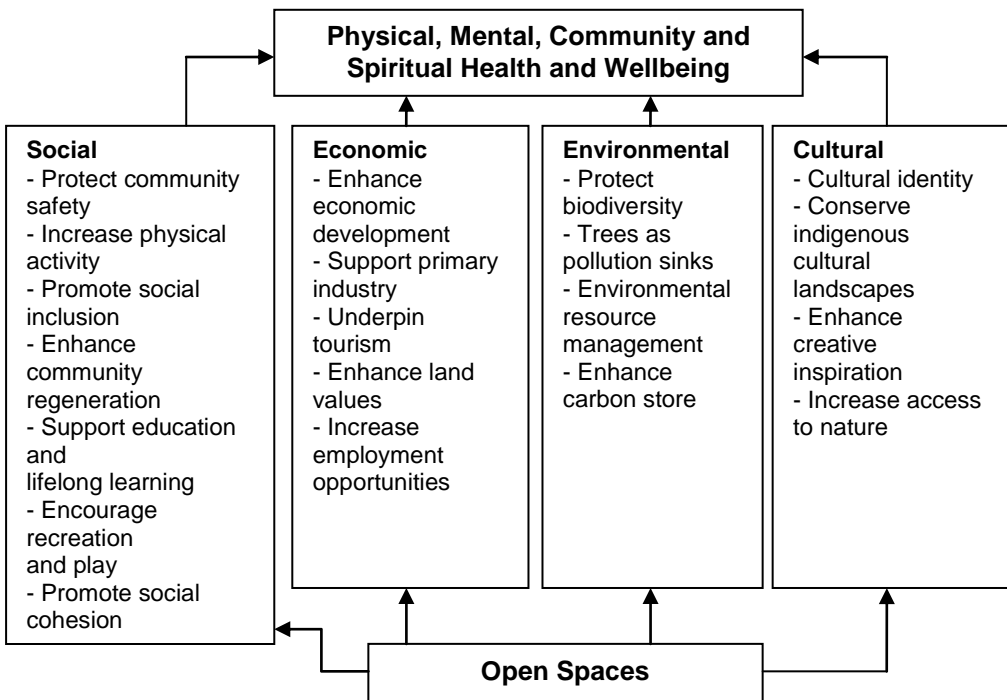


Major urban communities face these challenges in order to ensure a healthy and sustainable living environment for both the existing population and especially future generations.

The existence of green spaces within cities leads to improved water quality, air quality and mitigation of noise pollution and the impact of extreme natural phenomena, which may mean reducing the health risks associated with living in urban areas (Coldwell *et al.*, 2018; Johnston Eilidh *et al.*, 2008).

### MATERIAL AND METHOD

It is already known that green spaces generally support well-being, physical and mental well-being and facilitate good health by alleviating stress, relaxation, physical activity, improving social interactions and community cohesion. Even more, green spaces provided in the general urban planning projects, but also those that were subsequently built up by redevelopment of existing green spaces, or the rehabilitation of degraded urban areas will have a major impact on the urban population, through social, economic, environmental and cultural factor as it highlighted in figure 1 taken from second reference in paranthesis.(Lestan *et al.*, 2014; Regional Public Health., 2010; World Health Organization, Regional Office for Europe, 2017)



**Fig. 1** The impact of quality open spaces on human wellbeing through social, economic, environmental and cultural factors

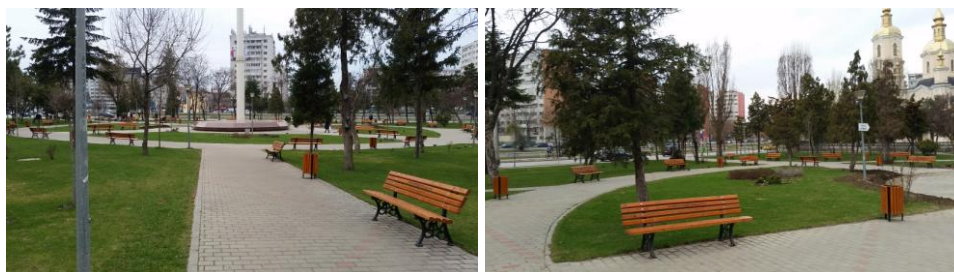
## RESULTS AND DISCUSSIONS

Interventions on urban green areas are defined as actions that change the quality, quantity and accessibility of landscaped green spaces, or by changing the features and functions of existing ones.

The city of Iasi has benefited from a series of rehabilitations and refurbishments of existing squares, which, through the new features, have gained better visibility, accessibility, new quality standards and last but not least their better attendance from the majority of inhabitants.

The question is whether these interventions on the green spaces in Iași have a positive or negative impact on the population of the city?

An example is the „Biserica Lipovenească” Square, which, after trimming the existing vegetation, extracting the aged specimens and the living fence, planting the lawn rug and some ornamental plant groups, resulted an light green space and much more frequented by citizens (fig. 2).



**Fig. 2** „Biserica Lipovenească (Orășel)” Square

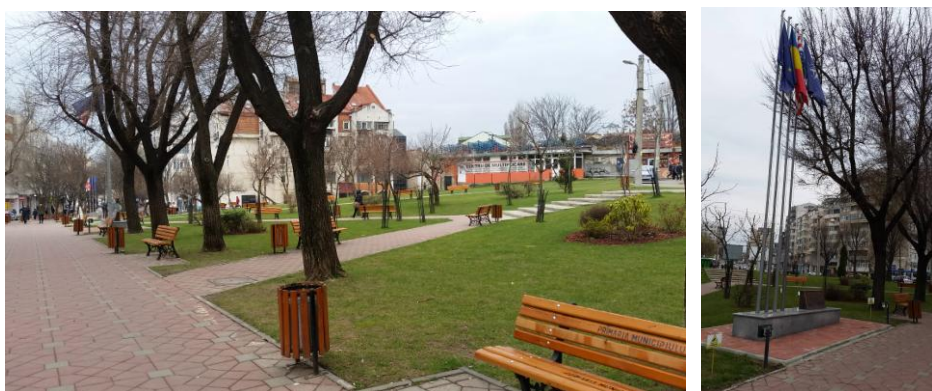
By introducing into the central ring a support platform for a Romanian flag, built for the celebration of the centenary of the Great Union of the Romanian lands, the square also gains a cultural significance, completing the works of regeneration and renewal of the vegetation and the furniture and giving to space the feeling of safety, but also belonging to a well-defined ethnic and cultural community.

Prior to the redevelopment, the area in front of the Post Office building, in the ”Podu-Roșu”, was the meeting place of the chess players from the neighborhood, very crowded despite the small space in the vicinity of a major traffic junction of the city, with a lot of noise and olfactory pollution.

After the refurbishment, the space, although more generous, cleaner, protected from noxious and noise through partially transparent perimeter panels, has the disadvantage of hiding the look of the outside passersby over what happens in the square and therefore does not seem to have the same attraction as before (fig. 3).



**Fig. 3** Chass player Square in "Podu-Roșu" area, (before redevelopment – the top-left image; after redevelopment – the top-right and the bottom image)



**Fig. 4** "Woodrow Wilson" Square, the „Târgu-Cucu” ring area

The square in the "Târgu-Cucu" area, besides a renewal of the arboricola and flora vegetation, new furniture and pavements, the area was given a new name - "Woodrow Wilson" - after the name of the American president during the First World War, and the main alley will be caled "Lt. col. Henry Watkins

Andreson”, where there is also a monument in memory of the American soldiers fallen in battles on the Romanian territory (fig. 4).

Initially this green space was a virgin land near the road traffic junction in ”Târgu Cucu” area, being planted at random with some arbustive and arboricol species and furrowed by several alleys that ensured the transit of space to the three main directions of circulation. The refurbishment consisted of: introducing several walking paths with adequate rest furniture, sanitation of healthy tree, extracting the living fence and shrubs that gave the feeling of insecurity, but also the introduction of a lawn rug and some arbustive and floral groups, maintained by a sprinkler irrigation underground system.



Fig. 5. ”Bicaz” Square (”Horia, Cloșca și Crișan”) Renovation Plan

”Bicaz” Square (Horia, Cloșca and Crișan), near the Union Square area of Iași, is one of the fully rehabilitated green areas which, with its new look and functionality, attracts more and more visitors (Servicii Publice Iași, 2017) (fig. 5, fig. 6)



Fig. 5. ”Bicaz” Square (”Horia, Cloșca and Crișan”) - pictures after redevelopment

All these examples are meant to highlight that, although the green spaces in Iași have begun to be rearranged, the impact of these interventions on the population can be observed directly in the short term, or can be assessed in the long run.

The first observations of the refurbished premises bring to light the fact that the areas have a bright, clean and airy appearance, which makes the spaces safer and consequently much more frequented by the population than they were before redevelopment. Was also noticed the reverse effect of the depopulation of the Chass Players Squar in Podu-Roș, by placing the soundproofing panels that obstruct the view from the outside space. The long-term effects of green areas on the population, both physically, mentally and socially, have been studied in other European countries as well. The findings show that there is certainly a beneficial effect on the population of green spaces appropriately tailored to the functions, but also to the age specific of the users (Lestan *et. al.*, 2014).

## CONCLUSIONS

Studies from abroad show that green spaces in general, but especially landscaped urban landscapes, have a positive impact on the population, both in terms of physical and mental health, as well as socially and economically.

On the other hand, exemplifications in the city of Iași, in addition to visible beneficial effects, can also illustrate the opposite, in that some arrangements are not made on the specificity of the area, or the users do not have the civic education necessary to exploiting this green spaces in good conditions.

## REFERENCES

1. **Coldwell Deborah F., Evans Karl L., 2018** - *Visits to urban green-space and the countryside associate with different components of mental well-being and are better predictors than perceived or actual local urbanisation intensity*, Landscape and Urban Planning 175, 114–122, <http://dx.doi.org/10.1016/j.landurbplan.2018.02.007>
2. **Johnston Eilidh, 2008** - *Health Impact Assessment of greenspace.A Guide*. Published by greenspace scotland, in colaboration with: Health Scotland,, Scottish Natural Heritage and Institute of Occupational Medicine, Scotland
3. **Lestan Katarina A., Eržen I., Golobič M., 2014** - *The Role of Open Space in Urban Neighbourhoods for Health-Related Lifestyle*, International Journal of Environmental Research and Public Health, no. 11, 6547-6570; ISSN 1660-4601 [www.mdpi.com/journal/ijerph](http://www.mdpi.com/journal/ijerph)
4. **\*\*\* Regional Public Health., 2010** - *Healthy open spaces. A summary of the impact of open spaces on health and wellbeing*, Regional Public Health Information Paper - March 2010, Wellington Region
5. **\*\*\* World Health Organization, Regional Office for Europe, 2017** - *Urban green spaces:a brief for action*, Copenhagen, Denmark.
6. **\*\*\* Servicii Publice Iași, 2017** – *Plan de amenajare a Squarului Horia, Cloșca și Crișan din Iași*, <http://www.spiasi.ro/module/portofoliul/2017/11/02/descriere.php>



## UTILIZATION OF 'GLORIOUS' ROSES IN URBAN LANDSCAPE DESIGNS

### UTILIZAREA TRANDAFIRILOR 'GLORIOUS' ÎN DIFERITE AMENAJĂRI PEISAGISTICE URBANE

COJOCARIU Mirela<sup>1</sup>, CHELARIU Elena Liliana<sup>1\*</sup>

\*Corresponding author e-mail: julia@uaiasi.ro

**Abstract.** *The roses whose flowers first appear at the beginning of summer, with various types of forms, perfumes and colours, could be, in many cases, an inspired alternative for the decor of various types of landscaping. The history of roses is long and contains several symbols. The sustained work of rose breeders made that today there is a tremendous variety of wonderful species. One of these is 'Glorious', a tea-hybrid rose, that impresses us with the beauty of its flowers, with a long flowering season and a very good resistance to diseases and pests. This paper has the purpose to study the use of 'Glorious' roses in several types of design in the urban landscape. Due to the form, perfume and colour of its flowers, this species can be used in various types of landscaping in urban areas.*

**Key words:** *Rosa 'Glorious', landscaping, urban design*

**Rezumat.** *Trandafirii, ale căror prime flori apar la începutul verii, cu diferite tipuri de forme, parfumuri și culori, ar putea fi, în multe situații, o alternativă inspirată pentru decorul diverselor tipuri de amenajări peisagere. Istoria trandafirilor este lungă și conține o mulțime de simboluri. Munca susținută a crescătorilor de trandafiri a făcut ca astăzi să existe o varietate enormă de soiuri minunate. Unul dintre acestea este 'Glorious', un trandafir teahibrid, care ne impresionează cu frumusețea de florilor sale, cu un sezon de înflorire lung și cu o rezistență foarte bună la boli și dăunători. Lucrarea curentă are scopul de a studia utilizarea de trandafirilor 'Glorious' în mai multe tipuri de design în peisajul urban. Datorită formei, parfumului și culorii florilor sale, acest soi poate fi folosit în diferite tipuri de amenajări peisagere de a în zonele urbane.*

**Cuvinte cheie:** *Rosa 'Glorious', amenajări peisagere, design urban*

## INTRODUCTION

Often adopted by royalty as an emblem, the rose constituted a significant symbol, centuries after centuries, for a large variety of emotions. It is an extremely well-known flower, recognised both by the specialists and by the ones not initiated in this field. Species brought by colonists, most likely from the northern hemisphere, it adapted and developed around the world. Nowadays, this species with so many types, with a long history full of colour and perfume, is amongst the most beloved flowers of the world (Mikolajski, 2007).

Regardless of the grouping type of the plants, either singularly or in compact groups, their presence can be a great interest point in any part of a landscaping.

---

<sup>1</sup>University of Agricultural Sciences and Veterinary Medicine Iasi, Romania

Moreover, they can also be a component of various vegetable compositions together with other species. In this manner, multiple combinations can be obtained, from delicate ones, to contrasting mixtures that make the most the aesthetic qualities of roses.

Usually, roses are placed in batches or borders, however, the adaptability they prove recommends them to be successfully used in various types of urban landscaping. One can create spectacular naturalist compositions, with various textures, either by planting them together with decorative plants and rustic perennial species of flowers. The correct selection of a species of rose for each type of landscaping, makes it enjoy the whole allure and beauty of roses, without minimising any other interesting aspect of the vegetable composition it is a part of.

There are forms and varieties suitable for any situation, from covering roses, with the help of which one can build genuine colourful vegetable carpets, from climbing ones, that can harmoniously cover high columns and pergolas.

Most modern roses combine a resilient constitution with a long period of decor. Some are delicate and elegant, extremely fragrant, other fascinate through electrifying, sometimes surreal colours.

The variety of colours is extremely wide from pastel colours, pink, cream-coloured or lilac to vibrant colours such as red, orange or intense yellow.

This paper has the purpose to study the behaviour of ‘Glorious’ roses so that they could be used in several types of design in the urban landscape.

## MATERIAL AND METHOD

The study material is represented by species Glorious (INTerectira), type Rosa L., created by G. Peter IIsink, Interplant Holland in 2000. Average-strength plant, presents thick and straight branches, light green and shiny leaves. Large flowers, with 17-25 yellow petals, that open slowly in a spiral. Weak perfume (<https://www.ivydenegardens.co.uk/Rose%20RHS%20G-R%20Wisley%20Gallery/r4glorious.html>).



Fig. 1 *Rosa* ‘Glorious’ development stages of the flower (original)

Research methods used: theoretical documentation, systematic observation, study case method, analysis and synthesis of the data obtained.

## RESULTS AND DISCUSSIONS

The tea-hybrids class groups into small species, with the height up to 1.5 m, with an increase that is mostly erect, with large flowers, with oval, elongated, solitary buds or with few flowers on a flower shank, that usually bloom twice, three times or even continuously (Wagner, 2002; <http://www.nsw.rose.org.au/Glorious-rose>). The roses grouped in this class come from the crossing of tea-roses with remontant roses (Wagner, 2010).

Flower shanks are long and that is why some species are used for the production of cut flowers in the field and protected spaces, and some are used for the decoration of public and private gardens, planted in groups.

'Glorious' roses, a tea hybrid, impress firstly through the beauty of their flowers of an intense yellow that amplified when the sun is shining. Buds appear and develop on 1-3 vertical, straight shanks. These are long, pointed, of a noble form that open in large (10 cm), involute flowers, with 20-25 petals (fig. 1) that releases a light, fruity perfume. The colour goes towards an intense yellow with orange reflections - in the bud stage - up to light yellow, towards cream white, towards the end of the blooming (fig. 2). It prefers sun exposure.



**Fig. 2** *Rosa 'Glorious'* colour evolution throughout the blooming (original)

The first flowers open at the beginning of June, sometimes even earlier, as early as the last decade of May, depending on the weather conditions. It blooms abundantly, in repeated waves until the arrival of frost. The average duration of a flower on the shank, under conditions of open field, is of 8 days.

The height of the scrub reaches up to 1.40 cm and has a compact, healthy aspect. The stems are long, resistant with green, shiny leaves. It is a resistant rose, with an abundant and repeated blooming.

It has a good resistance to diseases and pests.



It can be used as a cut flowers in various arrangements, as well as in various urban landscapes, in groups, rounds, platbands or borders. The abundant blooming, in repeated waves recommends it both for the compact plantation as a singular species, and in combinations with other species. Harmonious, dynamic compositions are obtained through their association with shrubs of various forms, colours and textures such as *Berberis thunbergii*, *Lonicera pileata*, *Buxus sempervirens*, *Euonymus fortunei* etc. in order to obtain dynamic, contrasting effects (fig. 3.).



Fig. 3 *Rosa 'Glorious'* in association with other vegetable species (original)

## CONCLUSIONS

The undeniable beauty both of the plants, but especially of the flowers, coupled most of the times with a fragrance highly special in intensity and composition, as well as the long period of decor make this species a good choice for the decoration of various urban spaces.

'Glorious' rose, with an intense golden yellow and a light fruity fragrance, maintains itself remarkably well and seems immune to external factors. The compact aspect of the shrub, the remonant, abundant blooming recommend it for usage both in simple border or in a mixture with other species, and in groups as splashes of colour.

## REFERENCES

1. **Wagner Ș., 2002** - *Trandafirul – de la mit la mileniul trei*, ECHARD &Co. SNC Cluj-Napoca
2. **Wagner Ș., 2010** - *Trandafiri cu parfum*, Editura Napoca Star, Cluj-Napoca
3. **Mikolajski A., 2007** - *Roses – selecting · growing · maintaining*, Apple press, Sheridan House, UK
4. \*\*\*, <http://www.nsw.rose.org.au/Glorious-rose>
5. \*\*\*, <https://www.ivydenegardens.co.uk/Rose%20RHS%20G-R%20Wisley%20Gallery/r4glorious.html>

**Consilier editorial:**

**Vasile VÎNTU**

**Tehnoredactori:**

**Elena Liliana CHELARIU**

**Corectori:**

**Lucia DRAGHIA  
Elena Liliana CHELARIU**

**Bun de tipar:**

**15.06.2018**

**Apărut:**

**2018**

**Format:**

**61x86/16**

**Editura:**

**„Ion Ionescu de la Brad” Iași  
Aleea M. Sadoveanu, 3  
Tel.: 0232-407471  
e-mail: [editura@uaiasi.ro](mailto:editura@uaiasi.ro)**

ISSN–L=1454-7376

(Print)-ISSN 1454-7376

(Online)=ISSN 2069-8275

(CD-ROM) = ISSN 2069 – 847X

**PRINTED IN ROMANIA**

**Editorial Consultant:**

**Vasile VÎNTU**

**Technical Editors:**

**Elena Liliana CHELARIU**

**Readers:**

**Lucia DRAGHIA  
Elena Liliana CHELARIU**

**Imprimatur:**

**15.06.2018**

**Published:**

**2018**

**Format:**

**61x86/16**

**Publishing House:**

**„Ion Ionescu de la Brad” Iași  
Aleea M. Sadoveanu, 3  
Tel.: 0232-407471  
e-mail: [editura@uaiasi.ro](mailto:editura@uaiasi.ro)**

ISSN–L=1454-7376

(Print)-ISSN 1454-7376

(Online)=ISSN 2069-8275

(CD-ROM) = ISSN 2069 – 847X

**PRINTED IN ROMANIA**